

# **diprotex**

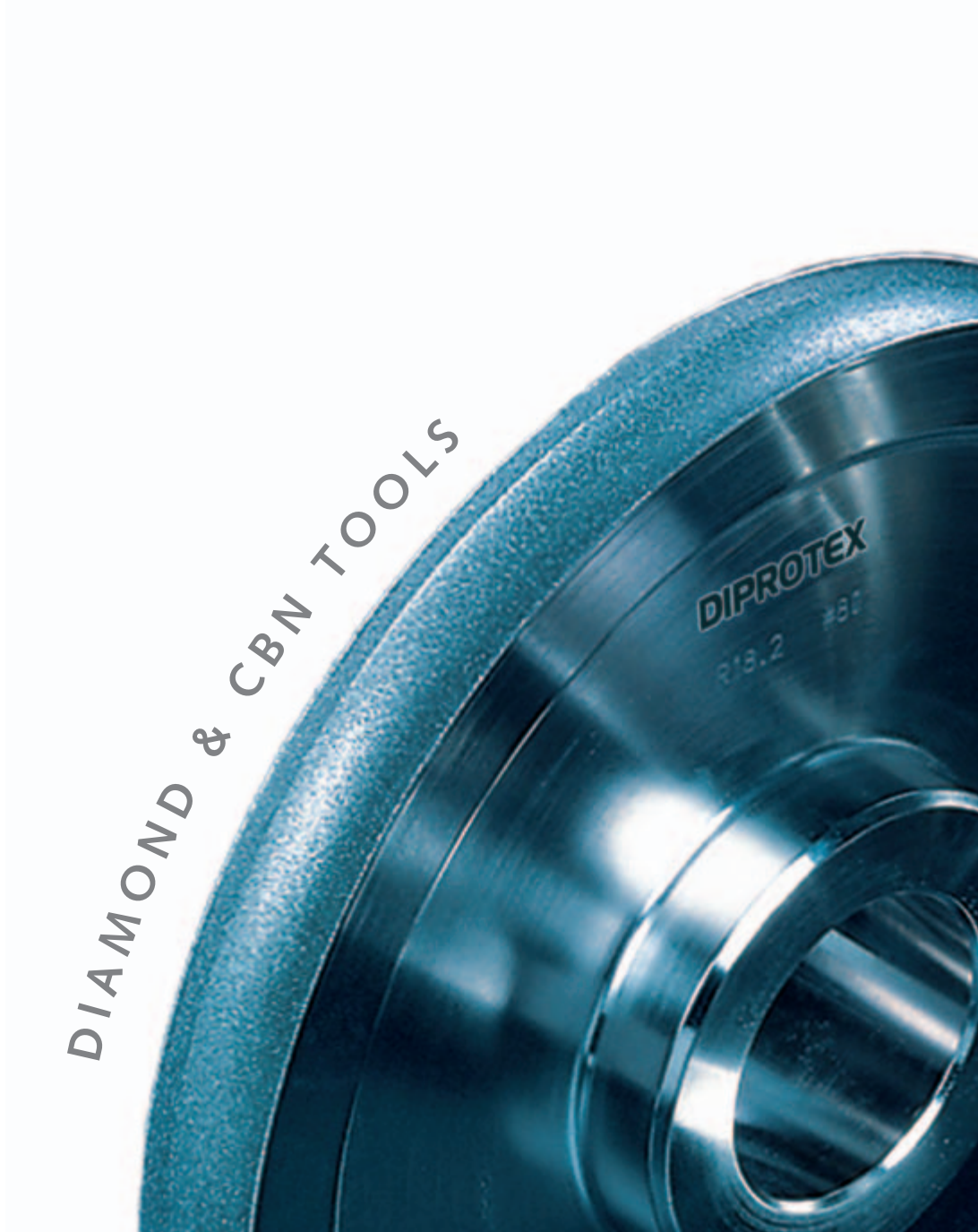

DIAMOND & CBN TOOLS

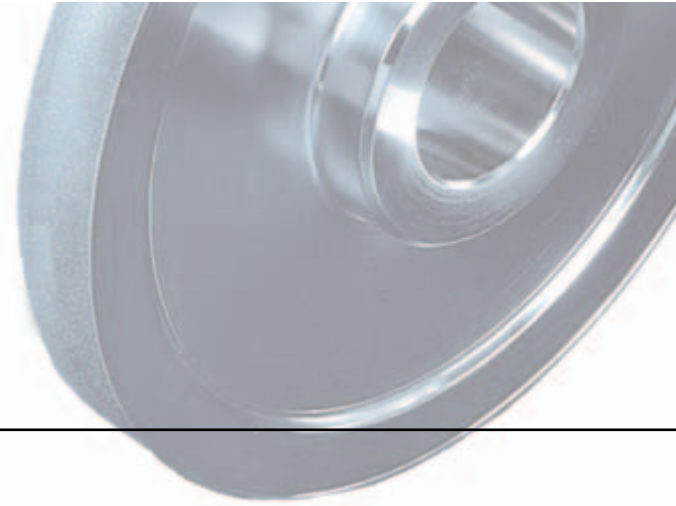

# **C**ontents

- 2** *HIGHLY STABILIZED PROCESS AND QUALITY CONTROL SYSTEM*
- 4** *HOW TO ORDER DIAMOND AND CBN GRINDING WHEEL*
- 5** *FACTORS OF GRINDING EFFICIENCY OF THE WHEELS*
- 6** *SELECTION CRITERIA OF DIAMOND AND CBN GRINDING WHEELS*
- 8** *CBN (CUBIC BORON NITRIDE)*
- 10** *BOND*
- 11** *APPLICATION OF DIAMOND GRINDING WHEELS*
- 12** *APPLICATION OF CBN GRINDING WHEELS*
- 13** *DIAMOND AND CBN RESIN BONDED WHEEL*
- 15** *DIAMOND AND CBN VITRIFIED BONDED WHEEL*
- 18** *DIAMOND AND CBN METAL BONDED WHEEL*
- 20** *DIAMOND AND CBN ELECTROPLATED TOOLS*
- 22** *DIAMOND ROTARY DRESSERS*
- 23** *DIAMOND DRESSERS*
- 25** *PCD & PCBN TOOLS*
- 26** *DIAMOND HIGH PRECISION TOOLS*
- 27** *WHEEL SHAPES*
- 28** *WHEEL AVAILABILITY*
- 42** *RELATION BETWEEN THE GRIT SIZE OF SUPERRABRASIVE AND SURFACE ROUGHNESS*
- 43** *TRUING AND DRESSING OF GRINDING WHEELS*
- 44** *FACTORS OF GRINDING EFFICIENCY OF THE WHEELS*
- 45** *TO ACHIEVE THE BEST GRINDING PERFORMANCE OF DIAMOND GRINDING WHEELS*
- 47** *TO ACHIEVE THE BEST GRINDING PERFORMANCE OF CBN GRINDING WHEELS*
- 48** *THE OPTIMAL CONDITION FOR PERIPHERAL SPEED AND REVOLUTION PER MINUTE (RPM)*

# Highly stabilized process and quality control system

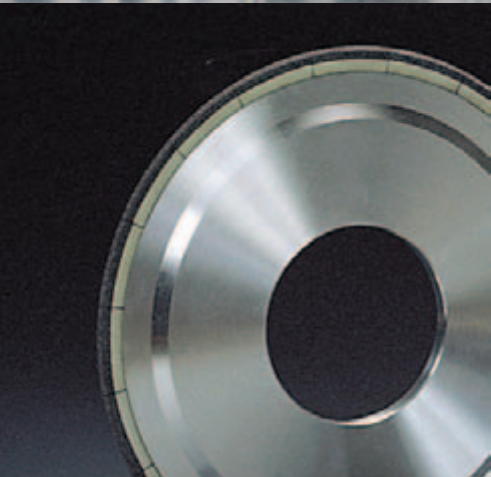

All manufacturing processes are tightly controlled in accordance with the ISO 9000 quality assurance system, and all data is fed back by statistical techniques, thereby contributing to tight process controls and incessant quality improvements. In particular, the sintering process is highly reliable as it is highly controlled. In addition, the computer control of all the processes, including the bar code system, has greatly reinforced these highly reliable techniques. Thus helping to maintain the established reputation for quality it is an essential process based upon our long-established know-how.

Various raw materials, including diamonds, are supplied from reliable sources in the world on a stable basis. This suggests that DIPROTEX is capable of supplying all customers with good quality tools on a continual basis. Our advanced technology and reliable production processes are primary factors in making DIPROTEX a recognized name in the world, today.

Recently the productivity of manufacturers has been adversely affected by increases in material and labor costs. In an effort to overcome this difficulty, DIPROTEX has concentrated all its efforts on productivity improvement and has automated a substantial portion of the manufacturing process.

# Highly stabilized process and quality control system

DIPROTEX has become an international benchmark for success because of our ability to quickly adapt to the changing market, to the diverse needs of customers, and by leading the way in applying the most advanced technology for industrial CBN and Diamond products.

Since 1968, DIPROTEX has been able to greatly expand its market share throughout the world, because we have established a world reputation of high quality products, service, knowledge and expertise in the industry. DIPROTEX is deeply committed to keep customers

up-to-date and equipped with the most competitive products and technical information. Our success can only be measured by the success of our customers. The keys of flexibility and strength in the global market are our many alliances with reliable overseas partners and customers throughout the world. DIPROTEX has successfully teamed up with high-tech manufacturers in Europe, Japan, and USA for the research and development of high precision diamond and CBN wheels and rotary dressers. The success of a company in today's world depends on its ability to adapt and to compete in the global marketplace. DIPROTEX is able to thrive in the age of globalization because we are already globalized. DIPROTEX is your partner for success.





## How to order diamond and CBN grinding wheel

To meet your requirements in every respect, we need the following informations:

- ① **Shape and Dimension of the wheel**
- ② **Grit size (Mesh, refer to table #1 - Page 6)**
- ③ **Concentration**
- ④ **Bond (Resinoid, Vitrified, Metallic, Electroplated)**
- ⑤ **Quantity**
- ⑥ **In addition to the above, please include the following details in order to ensure an accurate production:**

### A. Working condition

- a. Machine name & HP (power motor of wheel's broach)
- b. RPM of Diamond or CBN wheel
- c. RPM of workpiece
- d. Table speed (mm/min.)
- e. Depth/pass (mm)
- f. Infeed (mm/min.)
- g. Total stock removal
- h. Wet or Dry application
- i. Cycle time
- j. Grinding method (through feed, Infeed)
- k. Coolant
- l. Dressing method

### B. Work piece

- a. Material of workpiece
- b. Shape of workpiece (dimensions)
- c. Hardness of workpiece

### C. Required quality

- a. Surface roughness/Rmax, Ra or Rz)
- b. concentricity
- c. Straightness
- d. Others

### D. Special requirements

When purchasing an identical product, please specify the Code No. marked on the previous wheel.

Ref) Please refer to the list which shows all factors that affect grinding efficiency of the wheels.

# Factors of grinding efficiency of the wheels



# Selection criteria of Diamond and CBN grinding wheels

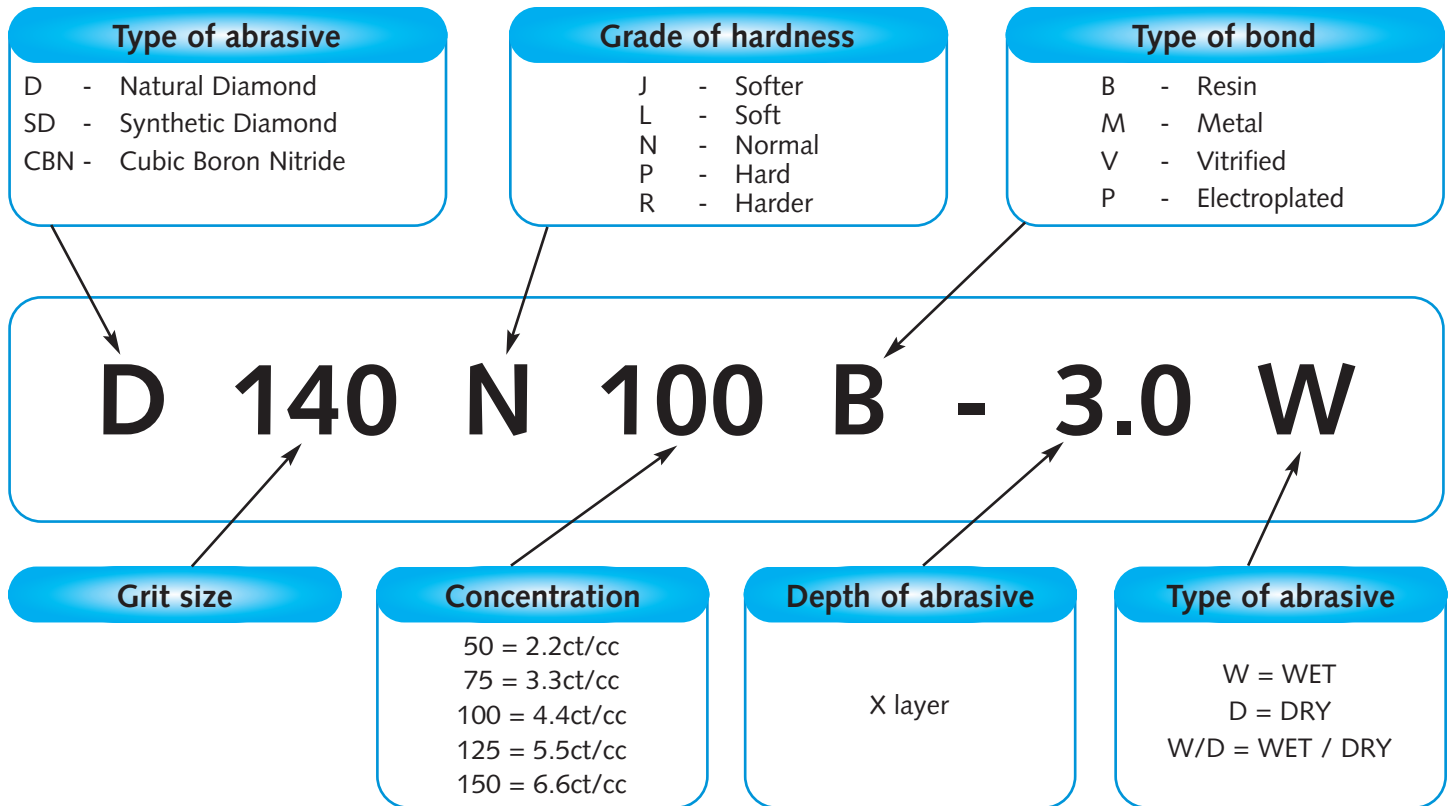

US(JIS)MESH	FEPA (μm)	Application
30/40#	D602	<b>GRINDING</b>
40/50#	D427	
50/60#	D301	
60/80#	D252	
80/100#	D181	
100/120#	D151	
120/140#	D126	
140/170#	D107	
170/200#	D 91	
200/230#	D 76	
230/270#	D 64	
270/325#	D 54	
325/400#	D 46	
400/500#	40-60	

US(JIS)MESH	MICRON (μm)	Application
500#	30-40	<b>LAPPING</b>
600#	22-36	
800#	20-30	
1000#	15-25	
1200#	10-12	
1500#	8-16	
1800#	6-12	<b>POLISHING</b>
2000#	5-10	
3000#	4-8	
5000#	3-6	
8000#	2-4	
12000#	1-3	
14000#	0-2	
28000#	0-1	
60000#	0-1/2	

Table #1. (Ref.)GRIT SIZE (μ) = 15000/M (M. : MESH SIZE)

# Selection criteria of Diamond and CBN grinding wheels

## Properties of Abrasives

The physical properties shown below in Table #2 are the main factors that determine the application range of Diamond and CBN wheels.

Property	Unit	Diamond	CBN
Density	g/cm <sup>3</sup>	3.52	3.48
Hardness (Knoops)	Kg/mm <sup>3</sup>	7000	4700
Hardness (Mohs)	-	10	9~10
Thermal stability	°C	600~700	1100~1400
Chemical property	-	C	BN

Table #2. Physical properties of Diamond and CBN

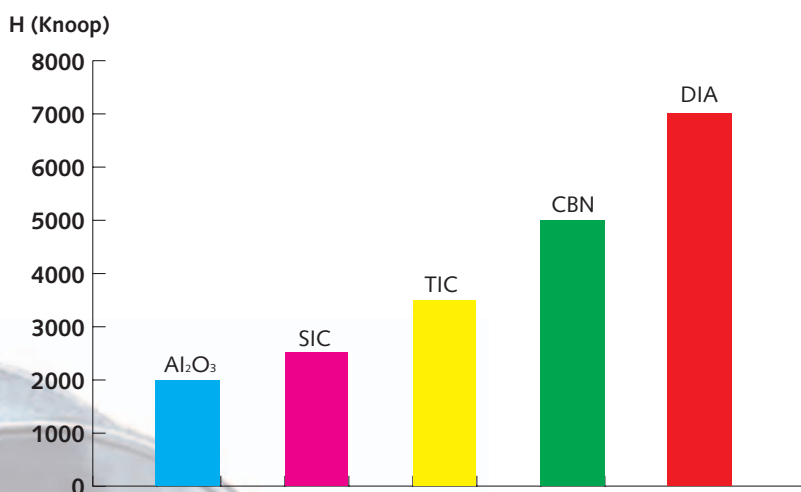

Fig 1. Diamond and CBN are harder than conventional abrasives that consist of Ceramic materials.

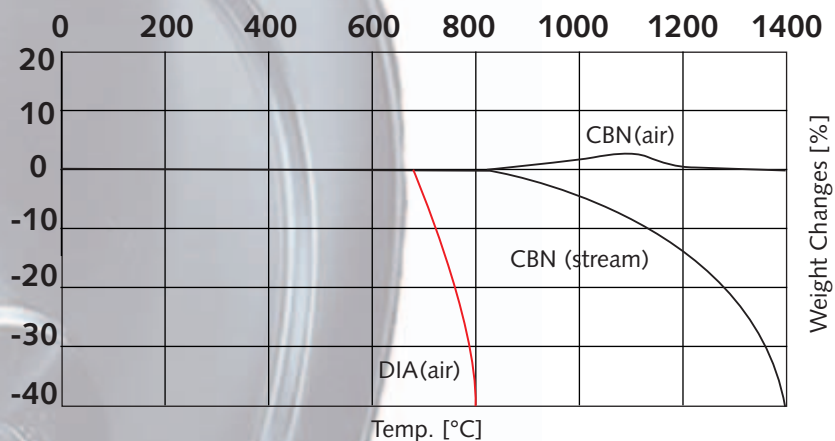

Fig 2. When subject to high temperatures, CBN has more resistance than Diamond against oxidization. CBN also shows less weight change caused by oxidization.





# CBN (Cubic Boron Nitride)

CBN, next to diamond in hardness, has the following specific properties.

## 1. CBN used for steel

CBN is a more suitable element than diamond when grinding steel. Intense heat is generated by the friction between the workpiece and grits on the grinding wheel during operation. CBN shows high heat resistance of up to about 1200°C while diamond is an inflammable element that begins to oxidize at about 600°C. Moreover, CBN does not have a chemical reaction to ferrous metals, whereas diamond since it contains carbon, is sensitive to ferrous metal.

## 2. CBN used for Hardened Steel

Hardened steel (over 60 HRC) could be processed with resin, vitrified, electroplated, or bonded grinding wheels which contain CBN coated with Ni. It has good grinding ability on various kinds of hardware such as Inconel Alloy 600 (Ni alloy contains Cr 16% and Fe 7%), Incolloy, Inconel, Hastelloy, super heat resistance alloy, and magnetic material like Alnico.

## 3. Grinding of Soft Steel

CBN metal bonded grinding wheel is useful for grinding the steel or cast iron which is under 45 HRC in hardness. Because the surface of CBN grit acts chemically on metal bond, it has therefore an excellent grip and makes soft steel easily grind with low cost.

## 4. Excellent grinding characteristics of CBN

- Low Grinding Temperature
- Excellent Ability for Grinding
- Longer Life
- Lower Cost
- Higher Grinding Ratio
- Longer Dressing interval
- Precise Measurements
- The Improvement of Working conditions

## 5. Application

CBN is recommended for the grinding, lapping, honing, and polishing of the following materials.

- Cutting Tools
- Mold
- Automobile parts
- Ball Bearing
- Roller Bearing
- Parts of Oil Pressure Machine
- Jet Engine parts
- Others

# CBN (Cubic Boron Nitride)

CBN, next to diamond in hardness, has the following specific properties.

## Hardness

It indicates the resistance of the bond to grits being removed during the grinding process. With the neutral level of N, as it goes toward A, bonding strength gets softer and grinding is increased. On the other hand, as it goes toward Z, life of the grinding wheel is increased and grinding ability gets lower.

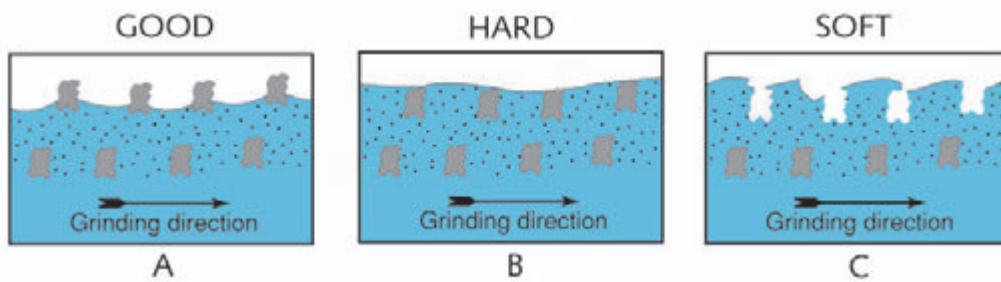

The wear resistance of the grinding wheel is very important factor when performing grinding operations. In reference to diagram A, the grinding wheel with optimal wear-assistance shows a suitable edge of diamond grits which allows a longer life of the wheel and low grinding resistance during use. In reference to diagram B, an excessively hard bond prohibits suitable exposure of diamond grits and results in deficient grinding. In reference to diagram C, as the bond is not strong enough to hold the diamond grits during grinding process, the abrasive grits are falling off, which has a bad effect on the life-expectancy of the tool.

## Concentration

Concentration is defined as the volume of abrasive grits in one cubic centimeter (= 1 cm<sup>3</sup>).

As the concentration increases, the life of the grinding wheel also increases. Moreover, a higher concentration gives better results on the work piece material, such as less chipping and better surface roughness. However, as the concentration increases, the cost also increases but the grinding performance is thereby, improved.

ex.) When concentration is 100,

- Amount = 4.4cts/cm<sup>3</sup>
- Weight = 1ct x 0.2 g = 0.88 g/cm<sup>3</sup>
- Volume = 25%

The above formula is applicable to both Diamond and CBN.

DISPOSITION OF THE GRITS									
	25	50	75	100	125	150	175	200	
CONCENTRATION	25	50	75	100	125	150	175	200	
cts/cm <sup>3</sup>	1.1	2.2	3.3	4.4	5.5	6.6	7.7	8.8	
Grit. vol. (%)	6.25	12.5	18.75	25	31.25	37.5	43.75	50.0	



# Bond

In order to properly grind the large range of material, a variety of bonding systems are used to hold the abrasive grits to the surface of the wheel core. Resinoid, Vitrified, Metallic, and Electroplated bonds are the four most common ones.

## 1. Resinoid bond (code B)

Resinoid bonds are manufactured with a mixture of measured amounts of phenolic or polyimide resin and filling agent. Phenolic resin is predominantly used at present, but polyimide is often used to increase wear resistance of the grinding wheels. Phenolic resin is used for medium finish or finish grinding of DIAMOND / CBN grinding wheels, and it shows various properties when mixed with organic or non-organic fillers.

Resinoid-bonded wheels can be designed for both wet and dry grinding modes, showing good free cutting qualities.

## 2. Vitrified bond (code V)

This, also known as ceramic bond, shows higher bonding strength than resinoid bonds do.

Vitrified-bond wheels are free cutting, they produce good surface roughness, they have good wear resistance and they retain straightness as well as form very well. The porosity (pores) or open structure of vitrified grinding wheels can be controlled to provide chip pocket, allow coolant in, and prevent. Wheels can be widely used in the automobile parts industry as well as bore processing of bearings, camshaft, injection parts, cylinders of engines, gear box, CVJ,...

## 3. Metallic bond (code M)

Metallic bonds are formed out of a compound of various metal powders such as Cobalt, Copper, Brass, Iron, Tin, Nickel, Tungsten, Silver and so on. Metal bonded wheels are produced through powder metallurgy method. They are well known for their excellent form-holding capabilities, high wear resistance, strength in productivity with longer life of wheel for brittle materials (Glass, Ferrite, Si, Ge, & Ceramics), high form retention for plunge, profile grinding & CNC grinding machine, and conductivity for electrolytic grinding. Thanks to their high wear resistance, metal bonded wheels are useful in the honing operation for ceramic and cast iron under low rpm.

## 4. Electroplated bond (code P)

Nickel is the most commonly used metal because it has good plating qualities and provides a bond of excellent strength. This bonding process makes it relatively easy to produce such wheels of any form or contour, depending on the shape and size of the steel core. This wheel shows such characteristics as highest stock-removal capability, maximum abrasive particle exposure and complex form easily manufactured while consisting of a single layer of superabrasive particles bonded to the wheel surface.

Especially, valuable for grinding deep forms such as gear teeth, splines and deep grooves, as well as eye-glasses and silicon wafer.

# Application of Diamond grinding wheels

WORKPIECE MATERIAL		GRINDING METHOD OR SHAPE OF ABRASIVES					APPLICATION	
		S T TYPE	CUP TYPE	CUTTING TYPE	FLUNGE DRILL	CORE DRILL	MACHINERY	OTHERS
TUNGSTEN CARBIDE AND OTHERS	T.C. ALLOYS	B.M	B.M.V	B.M	P	M	ALL KINDS OF CUTTING TOOLS	
	SINTERED T.C. ALLOYS	P	P	P	B.P	P	WEAR RESISTANT PARTS	
	CERMET, PCD, PCBN	B.V.M	B.V.M	B.M	M.B	M.B	T.A TIP	
CERAMIC	REFRACTORY MATERIAL	M	M	M	M.P	M		TILE
	GRAPHITE	M	M	M.P	B.M.P	M		MATERIEL FOR FURNACE
	Al <sub>2</sub> O <sub>3</sub> , ZrO <sub>2</sub> , ETC	B.M	B.M	B.M	B.M.P	M	THROW-AWAY TIP CUTTER	
	LiNbO, ETC	B.M	B.M	B.M	B.M.P	M	THROW-AWAY TIP CUTTER	
	SiC, SiN, ETC	B	B	B.M.	M.P	M		
AUTOMOBILE GLASS	OPTICAL GLASS	M	B.M	M	M.P	M		
	FLAT GLASS	M	B.M	B.M			BACK MIRROR WINDOW GLASS	MIRROR, WINDOW FURNITURE
	TUBE GLASS	M	B.M	B.M	M.P			PHYSICAL INSTRUMENT
	QUARTS GLASS	M	B.M	B.M.P	M	M		
	OTHERS	M	M	M		M		INDUSTRIAL PRODUCTS
BUILDING AND CONSTRUCTION MATERIAL	STONE		B.M	M		M		TOMB STONE BUILDING MATERIAL
	CONCRETE ASPHALT			M		M		ROAD & BUILDING
	SYNTHETIC MATERIAL	M	M	M		M		MATERIEL FOR WALL
JEWELRY AND SEMI JEWELRY	DIAMOND	B.M.V	B.M.V				WEAR RESISTANT PARTS	MEDICAL SUPPLIES
	RUBY	B.M.V	B.M.V					
	CRYSTAL	B.M	B.M.V					INDUSTRIAL PRODUCTS
	SEMI-JEWELRY	M	B.M	M	M.P	M		
FERRITE	PERMANENT MAGNET	M	M	M	P			
	AUDIO-FREQUENCY	B.M	B.M	B.M	B.M.P			
	HIGH-FREQUENCY	B.M	B.M	B.M	B.M.P			
SEMI CONDUCTOR	St, Ge	M	B.M.V.P	B.M.P	M			
	Ga. AS, OTHERS	M	B.M.V.P	B.M.P	M			
PLASTIC	ACRILIC RESIN	M.P	M.P	M.P	M.P	P		INDUSTRIAL PRODUCTS
	FRP	M.P	M.P	M.P	P	P		INSTRUMENT
	PLASTIC	P	P				BRAKE LINING	
	RUBBER	P	P	P	P		TIRE	
OTHERS	SHELL	P	P	P	P	P		"PADUK" STONE
	TEETH	P	P		P			DENTAL INSTRUMENT
METAL	CAST IRON	B.M	B.M				MACHINERY PART	
	SEMI-ALLOYS			M.P				
	Sn - Co		B	B.M.P				

M : METALLIC BOND    B : RESINOID BOND    V : VITRIFIED BOND    P : ELECTROPLATED BOND

# Application of CBN grinding wheels

WORKPIECE MATERIEL		APPLICATION			
		INTERNAL - COMBUSTION ENGINE	NORMAL MACHINERY PARTS	TOOLS	ELECTRONIC PARTS
HARDENED TOOL	H.S.S. (SKH)	VANE-PUMP PARTS	ROLL SPINDLE AND ANVIL OF MICROMETER	END MILL TAP DRILL HOB. BITE	
	HARDENED TOOL ALLOY				
		SKD	ROLL, GAUGE	MOLD & DIES	
	CARBON STEEL		KNIFE, RAZOR BLADE	MOLD	
STRUCTURAL ALLOY	S - C		MISSION PARTS		
	SCM SNC	FULL GEAR INJECTION	PRESSURE CYLINDER MISSION PARTS		
	SNCM SACM	CRANK GEAR PARTS FOR PUMP		MOLD	
BEARING STEEL	SUJ		BEARING		
CAM IRON		OIL SEAL CAM	COMPRESSOR PARTS MACHINE TOOL PARTS		
SINTERED METAL (WITH Fc)		POWER STEERING PARTS	COMPRESSOR PARTS		
MAGNETIC ALLOY	Sn - Co				VIDEO DRUM HEAD MAGNET
SUPER ALLOY			JET ENGINE		

Bond is recommended by our engineering service for each application.



## Diamond and CBN Resin bonded wheel

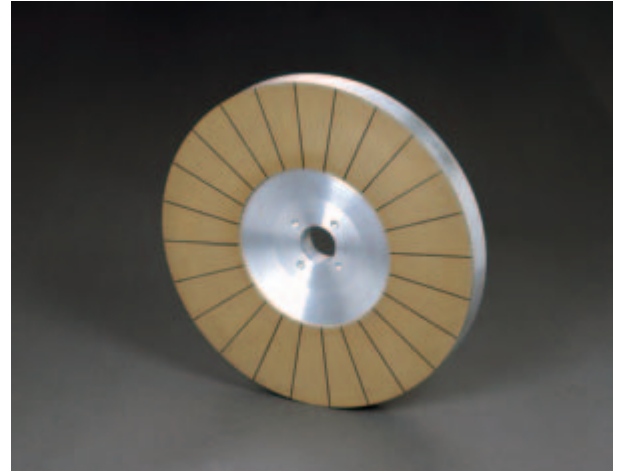
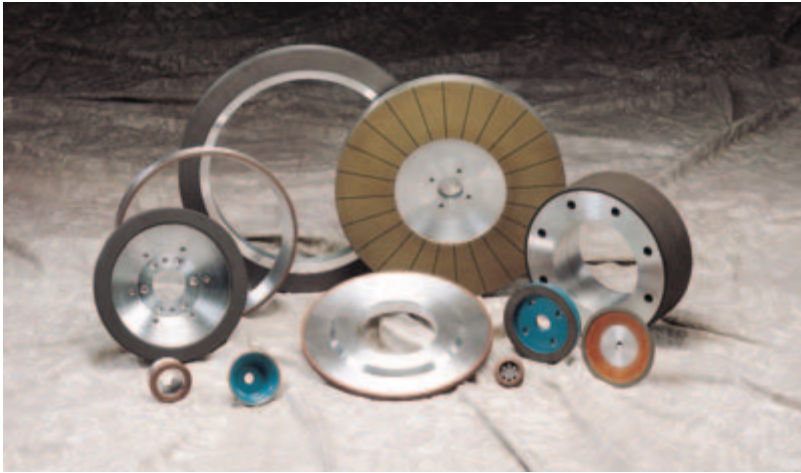

[DOUBLE DISC GRINDING]

The industrial Revolution was a catalyst in the rapid and gigantic growth of the auto and heavy machinery industries. As more and more "difficult-to-grind" materials and alloys were being used by these industries, the demand for higher quality, effective, and durable machine tools for cutting, grinding, and machining such materials continued to grow. As a result, superabrasive diamond and cubic boron nitride (CBN) tools were invented to meet the needs of these industries and their heavy requirements. Today, development and use of these specialized tools has expanded to various industries, as demand never ceases and new applications are being discovered.

One of the most demanded tools is the "resin-bonded wheel", which is manufactured through the curing process of bonding diamond or CBN abrasives, with inorganic fillers, and using resins as binders, such as phenol and polymid. Resin bonded wheels are now effectively applicable to all sorts of grinding operations such as surface grinding, cylindrical and centerless grinding, grooving and internal grinding, etc. It is ideally used for grinding super alloys, cermet, ceramic, glass, ferrite, high-speed steel, tool alloys, and many other new ultra-hard materials.

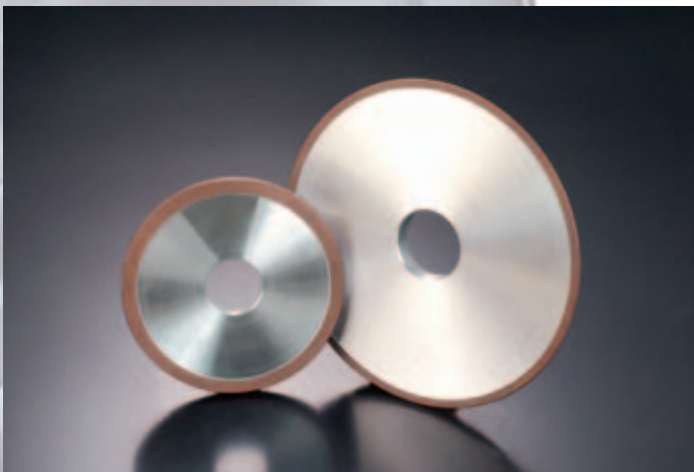

[FLUTE GRINDING FOR CUTTING TOOLS]



[INSERT T. CARBIDE GRINDING]

## Diamond and CBN Resin bonded wheel

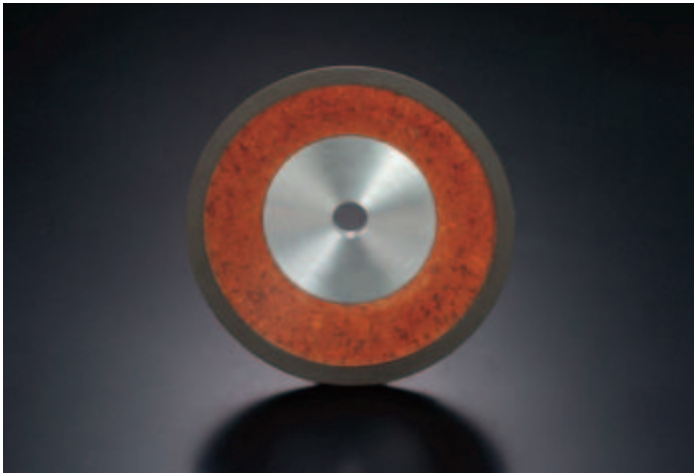

[SHARPENING CUTTING TOOLS FOR WOOD INDUSTRY]



[SHARPENING CUTTING TOOLS FOR METAL INDUSTRY]

Many types of resin-bonded diamond wheels are especially made for fast and cool cutting. These are particularly suited for the grinding of carbide tipped and inserted tooling, such as saws, cutters, reamers, end mills, etc. In addition, they are used for precision grinding operations on carbide dies, rolls and carbide wear parts. Resin bonds are the best choice for the precision finishing of ceramics as well as grinding tungsten carbide and ceramic thermal spray coatings. When combined with CBN, resin bonds can be used for grinding high-speed steels, tool and die steels, and superalloys with above HRC 50.

DIPROTEX offers to its customers the latest and highest quality of resin-bonded wheels available today. Our extensive R&D and expertise in diamond tools since 1968 are evident in all our products. DIPROTEX provides a complete line of resin-bonded wheels such as cylindrical grinding wheels, creep feed wheels, tip saw grinding wheels, insert grinding wheels, etc., and is reliable for mass-production ground parts, wet or dry with consistent high finish surface.

DIPROTEX is committed to serve and satisfy the demands of our global customers with high quality and reliable products at the most competitive prices, fast delivery, and trustworthy after-sales service.

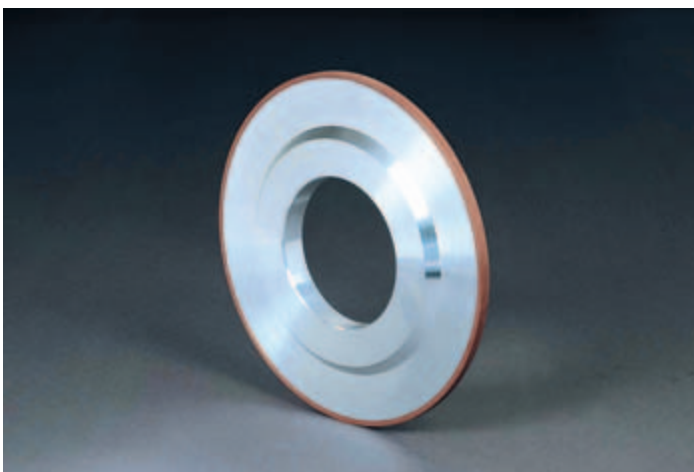

[STEEL & CARBIDE COMBINATION GRINDING]

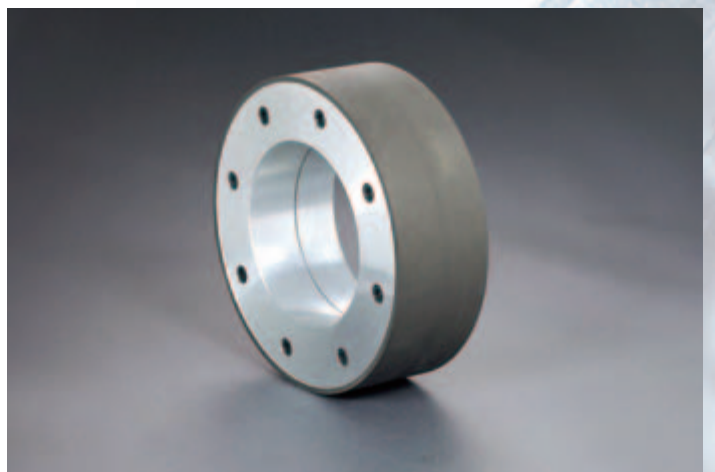

[CENTERLESS GRINDING FOR THROUGH FEED OR IN-FEED]

## Diamond and CBN Vitrified bonded wheel

There is a great demand for special bonded wheels are harder than both resin and which metal bonded wheels, for the use in automated equipment and systems, which both resin and metal bonded wheels will not suffice. These highly demanded bonded wheels must be durable with extended life and must be self-truing as well as self-dressing, in order to sustain maximum performance over long period of heavy uses. Vitrified-bond technology is today's answer. A vitrified bond is actually a ceramic bond. It is extremely hard, yet free cutting, and combines the best features of both resin and metal bonds. It provides a longer tool life, effective grinding, and high productivity, which is desperately sought after in order to provide maximum performance together with minimum maintenance.



[CAM SHAFT GRINDING]



[CVJ GRINDING]



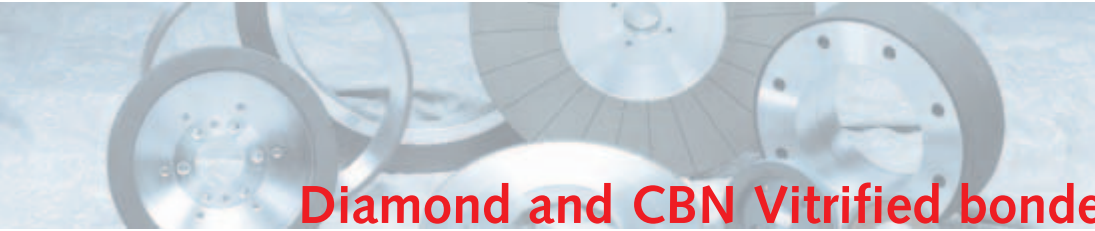

## Diamond and CBN Vitrified bonded wheel



[COMPRESSOR GRINDING]



[BEARING RING GRINDING]

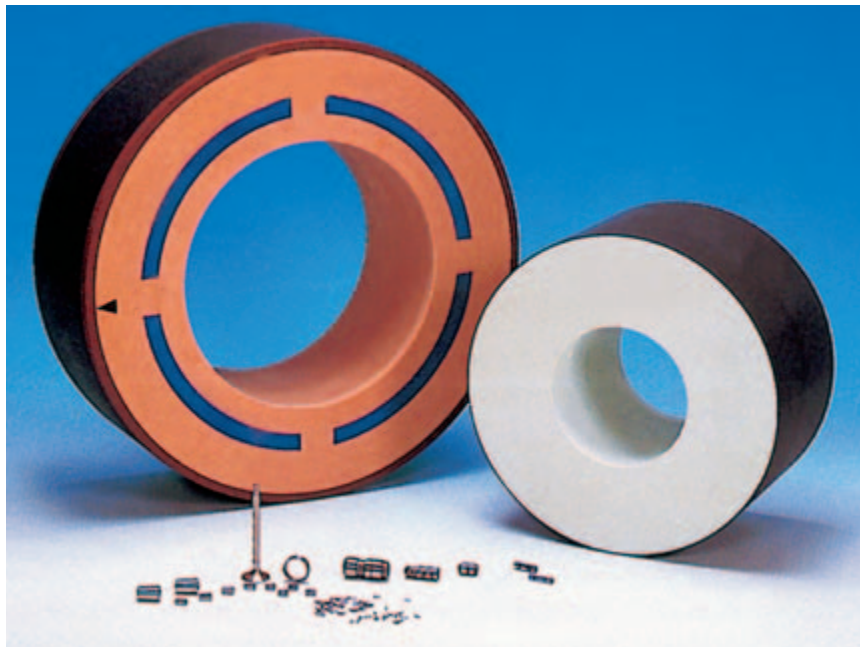

[CENTERLESS GRINDING AUTOMOTIVE PARTS]



[SLOT GRINDING]

## Diamond and CBN Vitrified bonded wheel



[PCD/PCBN INSERTS AND TOOLS GRINDING]



[BALL SCREW GRINDING]

Since the late 1980's DIPROTEX has developed high quality vitrified-bonded CBN wheels for grinding auto-parts, such as constant velocity ball joints. Thereafter, DIPROTEX expanded the development of vitrified-bonded wheels for many different applications such as for grinding high precision machine parts, bearings, gears, tools and dies, semi-conductors, ceramics, cermets, and particularly, cutting tools fabricated out of PCD or PCBN. Today, the demand for vitrified-bonded wheels is greatly increasing in various high-tech industries. DIPROTEX has put forth its best efforts without exception, to develop better quality and high-performance vitrified-bonded products to meet all diversified industrial applications.



[INJECTION NOZZLE GRINDING]

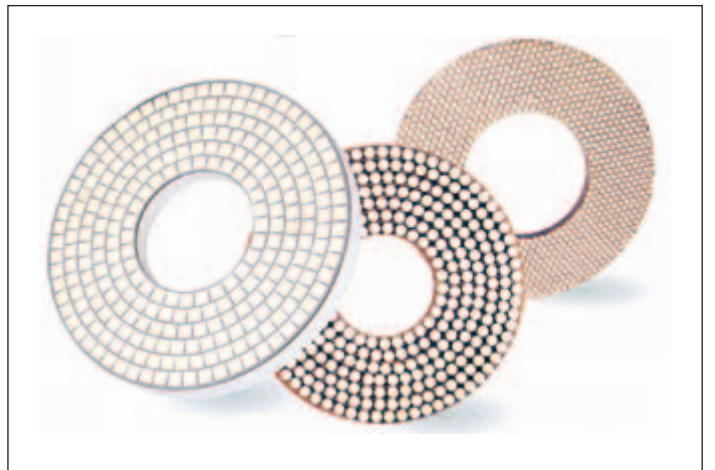

[DOUBLE DISC FINE GRINDING]



## Diamond and CBN Metal bonded wheel

The invention of glass is arguably one of the most important and useful discoveries in our history. Glass provides us with an esthetic and the ability to see beyond closed and limited space. Glass is used in every corner of the world for countless applications. Life without glass would be unimaginable. The endless applications and shapes of glass products are made possible by the use of special tools.

The manufacture of glass for any application is obviously a delicate process and not as easy as one may think. Special metal-bonded diamond wheels were invented to grind and shape various kinds of glass. These tools are designed to effectively and

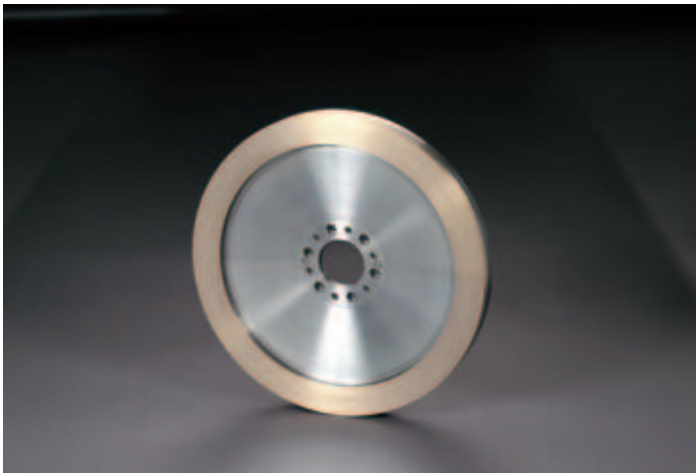

[GLASS PANEL & FUNNEL FOR TV]



[OPTICAL, GLASS LENS GRINDING]



[HONING STONES & TOOLS]



[FERRITE GRINDING]



## Diamond and CBN Metal bonded wheel

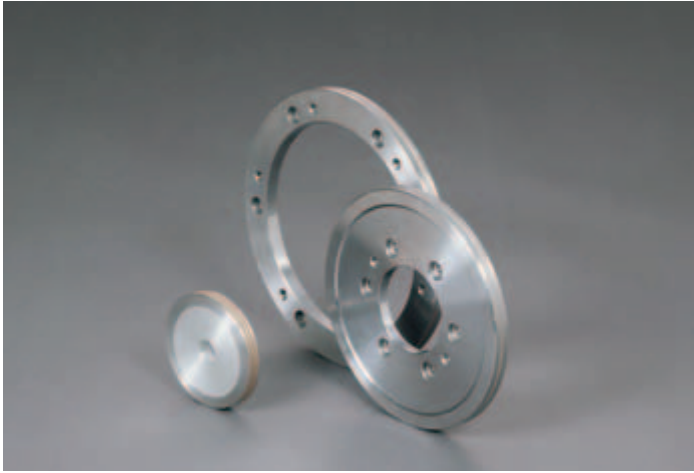

[EDGE GLASS GRINDING]

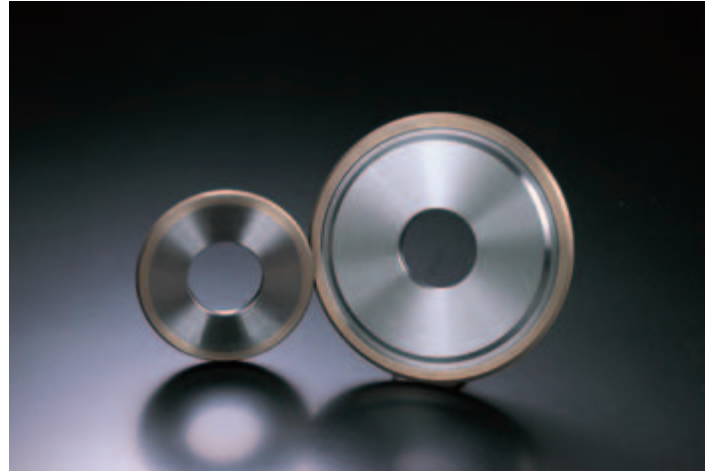

[CRYSTAL GRINDING WHEELS]

efficiently grind glass for uses such as television brown tubes, auto-glass, architectural glass, lens glass, and etc...

The applications of metal bonded wheels are unlimited. In addition to glass grinding, applications have extended to grinding and sharpening carbide tipped wood saws, ferrite, ceramic, tungsten carbide, auto-parts, quartz, stone, and etc....

DIPROTEX is committed to the continued development of high quality metal bonded wheels to meet the diverse needs of our valuable customers worldwide.



[CUTTING DISC FOR GLASS, CERAMICS, STONES]



[SAW SHAPING GRINDING]

## Diamond and CBN Electroplated tools



Electroplated diamond or Cubic Boron Nitride (CBN) tools are made up of a basic single layer or multi-layers (depending on application) of either diamond or CBN particles that are bonded to the tool surface using a nickel matrix. This bonding process allows for the manufacture of various tools with different forms and contours.

Electroplated diamond tools have high exposure and concentration of diamond/CBN particles which makes them denser than diamond/CBN tools made by other processes. This provides high stock removal and high efficiency for free cutting and grinding materials such as non-ferrous metals, hardened steels, FRP, ceramics, and composite materials.



[MOUNTED WHEELS]



[DIAMOND & CBN SAW BELT]

# Diamond and CBN Electroplated tools



[FERRITE GRINDING CONCAVE & CONVEX RADIUS]

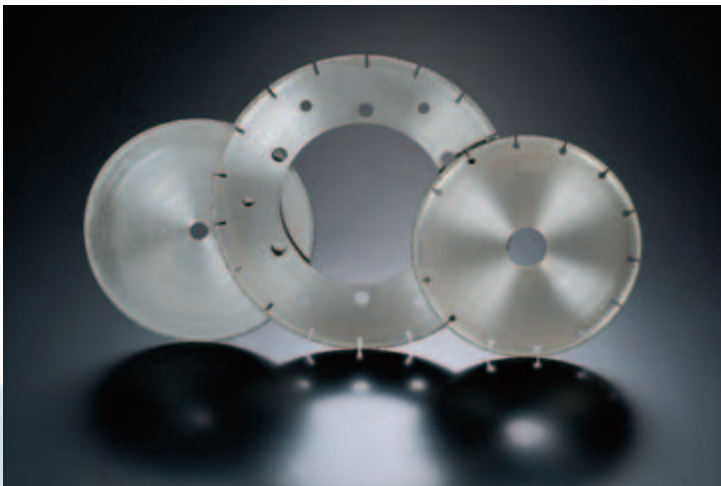

[CUTTING BLADES FOR COMPOSITE MATERIALS]



[EDGE GRINDING]



[DIAMOND HAND FILES]

## Diamond Rotary dressers

High precision diamond tools are the most effective and practical means for most high-tech industries in the modern world for manufacturing high precision machine parts, products, and other equipments. The automobile, aircraft, and turbine industries require extremely high precision machining and grinding tools, especially for application with new and advanced hard materials.

A diamond rotary dresser is a state-of-the-art diamond tool that enables mass production of extremely high precision products, such as engine and turbine parts for the auto and aircraft industries, at very competitive production costs.

DIPROTEX Diamond Rotary Dressers are engineered to quickly and accurately dress specific forms into aluminium oxide, silicon carbide and CBN grinding wheels for extremely high precision grinding. DIPROTEX Diamond Rotary Dressers are also ideal for dressing conventional abrasive wheels of specific profiles for grinding bearings, screws, and gears.

DIPROTEX guarantees to our global customers that we manufacture the highest quality rotary dressers that are able to meet the highest expectations and requirements of applicable use in any industry.



[ROTARY DRESSER FOR INJECTION PARTS]

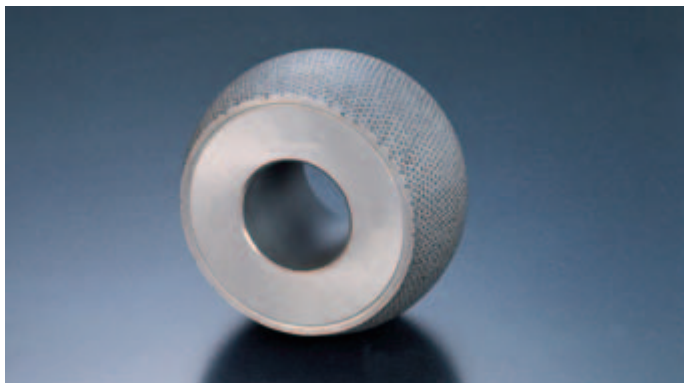

[ROTARY DRESSER FOR BALL JOINT]



[ROTARY DRESSER FOR CUTTING TOOLS]

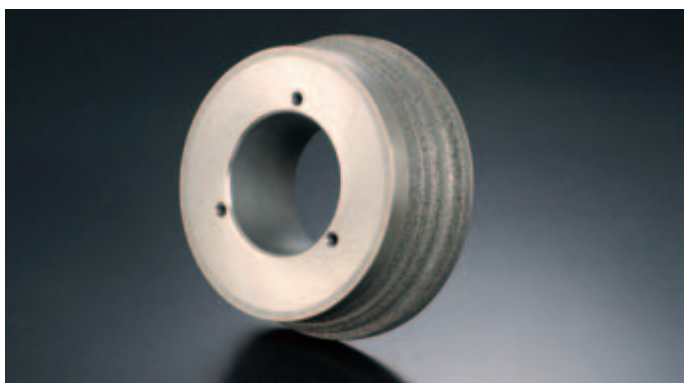

[ROTARY DRESSER FOR AIR CRAFT BLADE]



[ROTARY DRESSER FOR OBLIQUE EXTERNAL GRINDING]

# Diamond dressers

The importance of dressing and truing abrasive grinding wheels can never be over-emphasized. Dressing will restore the exposure and cutting ability of the abrasives on the wheel surface. Dressing must be performed after truing or whenever the wheel surface becomes loaded or glazed, or has lost its cutting ability. Dressing removes the unwanted residue, such as braze and steel particles, from the wheel surface. Dressing also removes a certain small portion of the bond material and exposes the abrasives, thus allowing for effective cutting action. Truing is the procedure for eliminating any unwanted "run-out" once the wheel has been mounted. Truing is best done wet.



In general, there are four types of dressers:

- 1) Single point diamond dressers
- 2) Multi-point diamond dressers
- 3) Forming diamond dressers
- 4) Impregnated diamond dressers

## 1. Single-point Diamond Dressers

This type of dresser is made by sintering together a selected diamond crystal with a metal matrix in a steel shank. The point of the set diamond is concentric with the shank.



[SINGLE POINT DIAMOND DRESSERS]

## 2. Multi-point Diamond Dressers

This type of dresser is made by sintering together two or more diamonds with a metal matrix to provide multi-diamond points for dressing larger and wider abrasive wheels. There are many advantages for multi-point diamond dressers. The multi-points allow the spreading of resistance, thus reducing frictional heat, extending tool life, reducing likelihood of early failure, and allowing faster dressing.



[MULTI POINT DIAMOND DRESSERS]





# Diamond dressers



[FORMING DIAMOND DRESSER]

### 3. Forming Diamond Dressers

This type of dresser is made by sintering a high quality mono-diamond crystal with a metal matrix in a steel shank, and then grinding into various shapes such as a conical point with radius, facet, or profile.

### 4. Impregnated Diamond Dressers

This type of dresser is made by sintering a mixture of selected diamond particles with a metal matrix. This provides a longer tool life, it is very economical, and it is ideal for use with larger and wider abrasive wheels. DIPROTEX is committed to developing all kinds of diamond dressers by applying up-to-date technology for supporting our customers around the world.



[IMPREGNATED DIAMOND DRESSERS]

## PCD & PCBN Tools

Today's modern industrial society continues to push development and uses of new and advanced materials, as well as high precision machining to new heights. Along with the improvements in production processes and difficulties that arise from machining new and advanced materials, there is an increasing demand for new forms of cutting tools that spreads out beyond the conventional cutting tools such as those made out of high speed steel, tungsten carbides, cermets, and ceramics.

Polycrystalline Diamond (PCD), is a synthetic diamond product that is produced by sintering together selected diamond particles with a metal matrix using very sophisticated high temperature and high pressure technology. The PCD is by its nature, high in uniform hardness, and also more abrasive and shock resistant in all directions as compared to natural diamonds because of the random-orientation structure of its diamond particles.

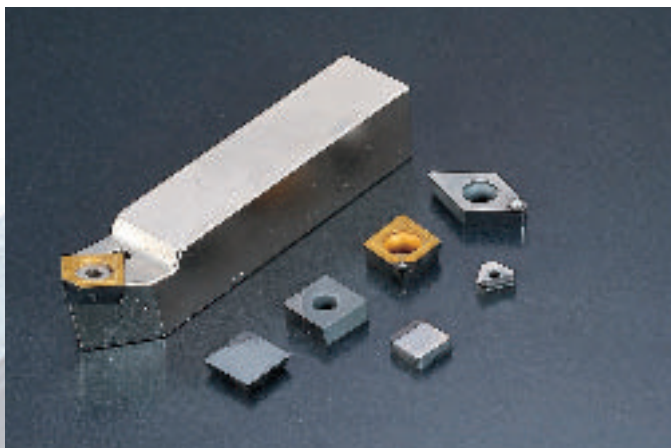

[INSERTS]

DIPROTEX PCD and PCBN cutting tools are highly sought by customers worldwide from the aircraft industry, auto industry, iron and steel industry, precision watch industry, to the electric and electronic industries. DIPROTEX will continue to improve tool performances in order to meet our valuable customers' expectations throughout the world.

Polycrystalline Cubic Boron Nitride (PCBN) is an artificial synthesized material. Its hardness is exceeded only by the diamond. However, unlike diamond, PCBN is stable under high temperature conditions (up to 1000°C), normally seen when machining hardened ferrous or super alloy materials. PCBN tools permit metal cutting at feeds and speeds that are much higher than conventional cutting tools.



[PISTON GROOVING TOOLS]

## Diamond High precision tools

Over the past twenty years, the electric, electronic, and semi-conductor industries of the world have grown to unimaginable levels and will continue to reach greater heights at even greater speeds. These industries, especially for silicon wafer fabrication, demands high precision diamond tools to reach the extremely high level of accuracy and mirror finishing required to manufacture their respective products.

DIPROTEX has engineered state-of-the-art diamond tools of extremely high precision such as micro-multi-blades, special wafer surface or back grinding wheels, wafer edge grinding wheels, and wafer dicing blades of various sizes.

DIPROTEX assures our global customers that we are using the most-advanced equipments and facilities to manufacture and supply high precision diamond tools, and we will continue to make further strides to meet all future needs and applications.



[MICRO BLADES]



[SILICON WAFER BACK GRINDING]



[DIAMOND HUB BLADE]



[CMP PAD CONDITIONNERS]

# Wheel Shapes

TYPE	PAGE	TYPE	PAGE	TYPE	PAGE
1A1	28	4A2	33	11V9	37
1A8	28	4B2	33	11Y9	38
1A1R	29	BT9	34	12A2	38
1E1	29	6A2	34	12V4	39
1EE1	29	6A2C	35	12V9	39
1E6Q	30	6A9	35	14A1	39
1V1	30	6F2	35	14EE1	40
1FF1	31	6P5	36	14U1	40
1FF6Y	31	9A3	36	1A1W	41
2A2T	32	11A2	36	HH1	41
2FF2	32	11B2	37	HMF	41
3A1	32	11C9	37	PELLET	41

# Wheel Availability

## TYPE 1A1

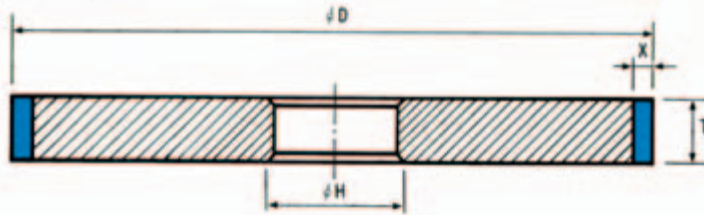

D	T	X	BOND
15	3 - 13	1, 5, 2, 3	B, M
		3	V
20		1, 5, 2, 3	B, M
		3	V
22		1, 5, 2, 3	B, M
		3	V
25 - 35	3 - 20	1, 5, 3, 5	B, M
		3, 5	V
40 - 70	3 - 22	1, 5, 3, 5	B, M
		3, 5	V
75, 100, 125	3 - 10	3	B, M
150, 175, 200	3 - 25	3, 5	B, M, V
250, 300	5 - 25		
350, 400, 450	13 - 30		
500, 550, 600	20 - 45		

## TYPE 1A1 -- over 50MM thick

D	T	X	BOND
250, 300, 350	50, 75	3, 5	B, M, V
400, 450, 500	100, 125, 150		

## TYPE 1A8

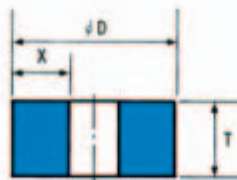

D	T	X	BOND
10	3 - 13	3	B, M, V
13	3 - 15	3, 5	
15	10 - 20	3, 5, 6	
20 - 30		3, 5, 8	

# Wheel Availability

TYPE 1A1R

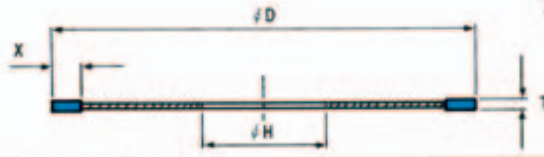

D	T	X	BOND
75, 100	0,5 - 0,65	4	B
125, 150	0,66 - 3,0	4, 7	
175	0,7 - 3,0		
200	0,8 - 3,0		
250	1,0 - 3,0		
300, 350	1,2 - 3,0	7	
400	2,2 - 3,0		

TYPE 1E1

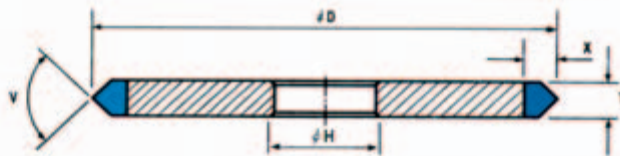

D	T	X	V	BOND
75, 100	3	3	90° & larger	B, M, V
		5	60° & larger	
		6	45° & larger	
		8	30° & larger	
125, 150	5	5	90° & larger	
		8	60° & larger	
		10	45° & larger	
175, 200	5	5	90° & larger	
		8	60° & larger	
		10	45° & larger	

TYPE 1EE1

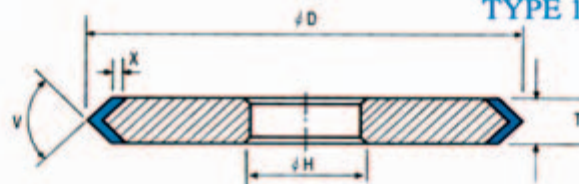

D	T	X	V	BOND
75, 100	3, 5	3	30° & larger	B, M
	10		45° & larger	
125, 150	13		60° & larger	
	20		90° & larger	
	10		45° & larger	
175	13		60° & larger	
	20		90° & larger	
	5, 10, 13		60° & larger	
200, 250, 300	15, 20		90° & larger	

# Wheel Availability

**TYPE 1EE1**

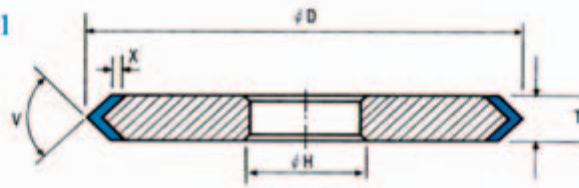

D	T	X	V	BOND
75, 100 125, 150	3, 5	3	30° & larger	B, M, V
	10		45° & larger	
	13		60° & larger	
	20		90° & larger	
175	10		45° & larger	
	13		60° & larger	
	20		90° & larger	
200, 250, 300	5, 10, 13		60° & larger	
	15, 20		90° & larger	

**TYPE 1E6Q**

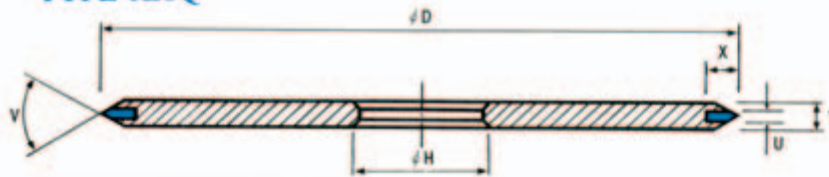

D	T	X	U	V	BOND
75, 100	5, 6	5, 10	1,3 - 2,0	45°, 60°, 90°	B
125, 150	5, 10, 13	10, 13	1,3 - 3,0		
175, 200					

**TYPE 1V1**

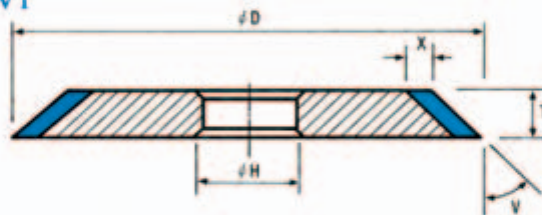

D	T	X	V	BOND
75, 100	3 - 13	3, 5	5°	V
			5° - 45°	B, M
125			5°	V
			5° - 45°	B, M
150			15, 20	
			3 - 13	5°
	5° - 45°	B, M		
175, 200	15 - 25		10° - 30°	
		5°	V	
	5° - 45°	B, M		
250, 300	5, 10, 13		10° - 30°	
		5°	V	
	5° - 45°	B, M		
15 - 25	10° - 30°			

# Wheel Availability

TYPE 1FF1

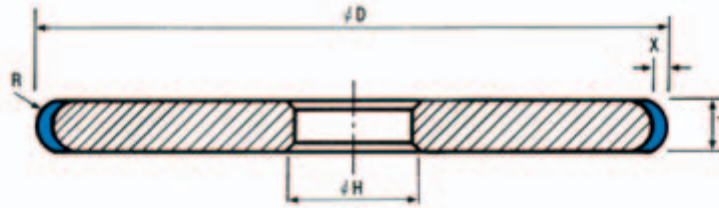

D	T	X	R	BOND
50, 75	3	3, 5	1,5	B, M
	5		2,5	
	6		3	
	8		4	
	10		5	
	12		6	
100, 125	3		1,5	
	5		2,5	
	6		3	
	8		4	
	10		5	
	12		6	
150, 175 200, 250	15		7,5	
	5		2,5	
	6		3	
	8		4	
	10		5	
	12		6	
	15		7,5	
	20		10	
	22		11	
25	12,5			

TYPE 1FF6Y

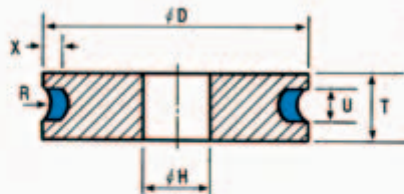

D	T	X	U	BOND
100, 125	20	3, 5	5 - 13	M
150, 175, 200, 250	15		2 - 5	



# Wheel Availability

## TYPE 2A2T

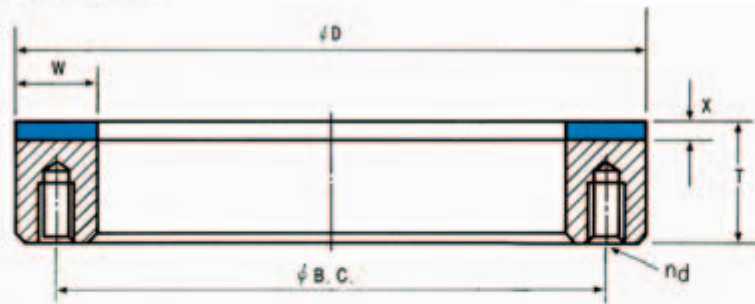

D	T	W	X	BOND
200, 250, 300	20, 22, 25	5, 10, 15, 20, 25	3, 5	B, M
350, 400		10, 15		
450, 500, 550		20, 25		

## TYPE 2FF2

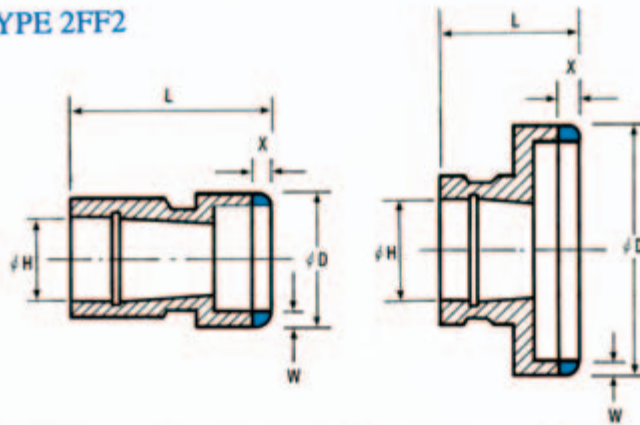

D	W	X	BOND
10 - 125	2	6, 8	M

## TYPE 3A1

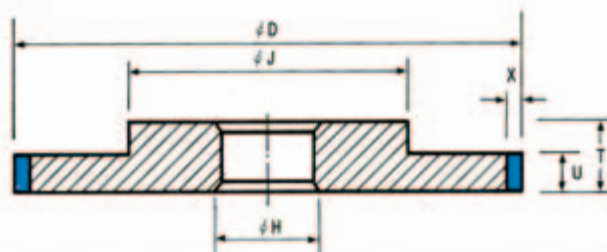

D	T	U	X	BOND
75, 100, 125	15, 20, 25	3, 5	3, 5	V
150, 175, 200	15, 25, 30		2, 3, 5	B, M
250, 300, 350	25, 35	3, 5, 10	3, 5	B, M, V
400, 450	35, 50	5, 13, 20		
500, 550, 600		13, 20, 25		

# Wheel Availability

TYPE 4A2

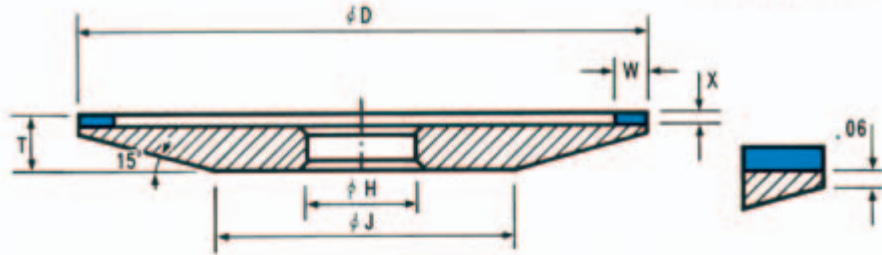

D	T	W	X	BOND
75, 100, 125, 150	6 - 25	3, 5, 10	1, 5, 3	B, M
175, 200, 250	13 - 25	5, 10, 13	3, 5, 6	

TYPE 4B2

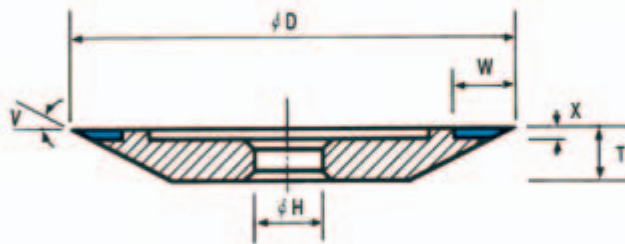

D	T	W	X	V	BOND	
100	6	5	1.5	15°, 30°, 45°	B, M	
		8				
		10				
125	10	8	1.5			
		10				2.0
		12				
150, 175, 200	13	5	1.5			
		8				
		10				2.0
		12		3.0		

# Wheel Availability

**TYPE 4BT9**

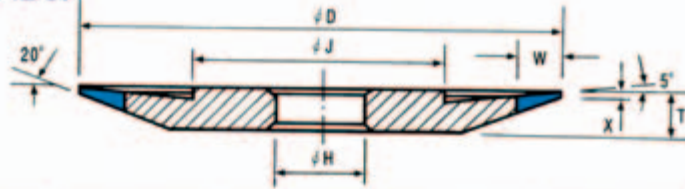

D	T	W	X	BOND
75	6	5, 6	1, 0, 2, 0	B, M
100	10	5, 6, 10		
125, 150	13			
175, 200	15			

**TYPE 6A2**

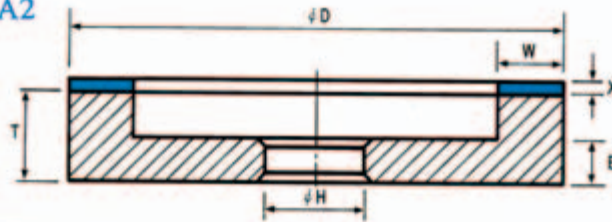

D	T	W	X	E	BOND
50	15	3	1.5, 3	5	B, M
			3		V
75		3, 5, 10	1.5, 3		B, M
		100, 125	3, 5, 10, 15		3
1.5, 3					B, M
3, 5			V		
150	20		1.5, 3	B, M, V	
	25, 30	5, 10	3, 5	B, M	
15, 20, 25		10		B, M, V	
175, 200, 250	30 - 95		10, 15, 20, 25	15	B, M, V
300, 350					

**TYPE 6A2 - over 25MM rim width**

D	T	W	X	E	BOND
150, 175, 200	25	25, 50	3, 5	20	B, M
250, 300, 350	25, 50	25, 50, 75			
400, 450, 500	25, 50, 75	25, 50, 75, 100, 125			



# Wheel Availability

TYPE 6A2C

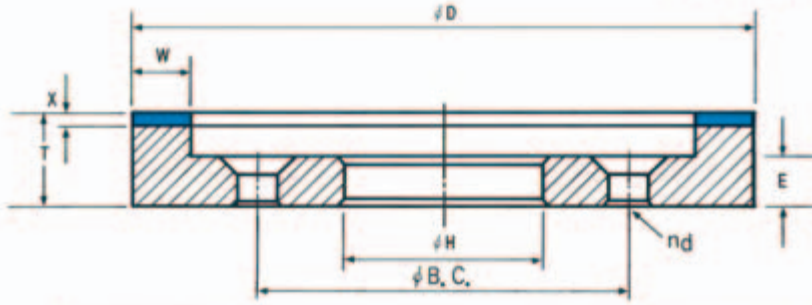

D	T	W	X	E	BOND
150	20	5, 10 15, 20, 25	1, 5, 3	10	B, M
175, 200, 250	25, 30		3, 5		B, M, V
300, 350		20, 25, 50		13	

TYPE 6A9

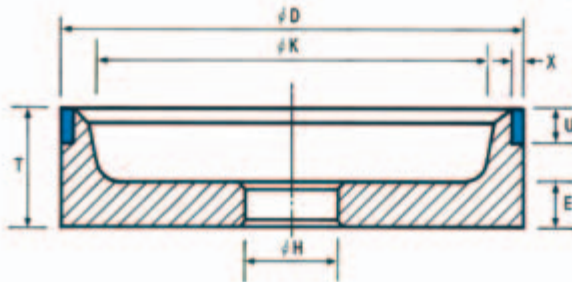

D	T	U	X	E	BOND
100, 125	30, 38, 45	5 - 12	1, 5, 3	10, 13	B, M
150			3		
175, 200, 250, 300	38, 45				

TYPE 6F2

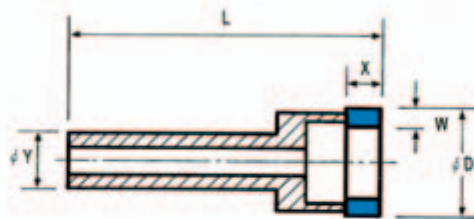

D	W	X	L	BOND
5 - 25	1, 0, 1, 3	5	75, 100	M
27 - 100	1, 5	9		

# Wheel Availability

## TYPE 6P5

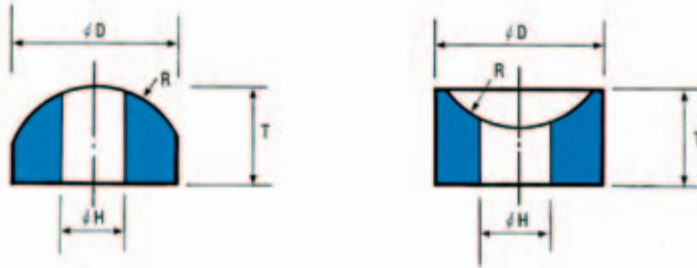

D	T	BOND
5 - 30	10, 13, 20	M

## TYPE 9A3

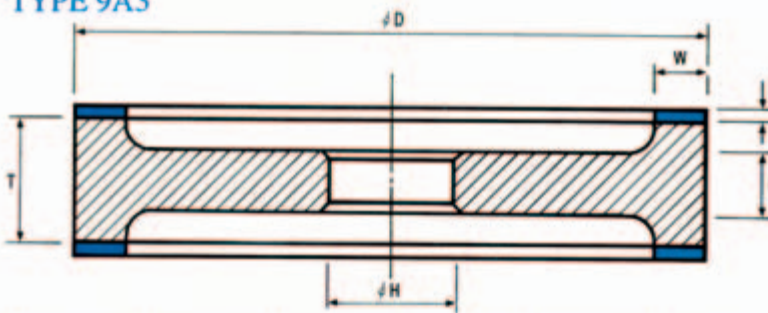

D	T	W	X	E	BOND
100, 125	22, 25, 30	5, 10	1.5, 3	10	B, M
150, 175, 200	25, 30	5, 13, 20	1.5, 3, 5		
250, 300, 350	30, 50		3, 5	13	

## TYPE 11A2

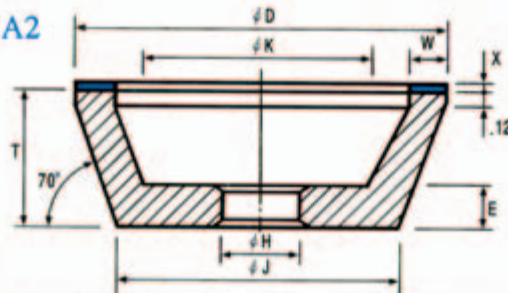

D	T	W	X	E	BOND		
75	22 - 30	3, 5, 10	1.5, 3	10	B, M		
			3		V		
1.5, 3			B, M				
3			V				
100, 125	25 - 45	5, 10, 13	1.5, 3, 5	10	B, M		
3, 5			V				
150	175, 200, 250		5, 10, 13		1.5, 3, 5	10	B, M
3, 5					B, M, V		

# Wheel Availability

TYPE 11B2

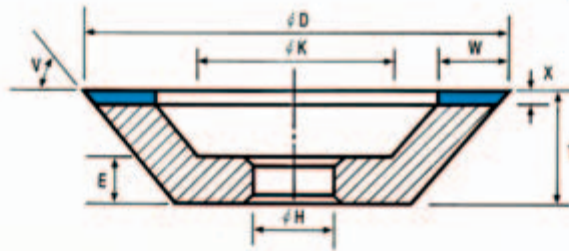

D	T	W	X	E	V	BOND
75	25	3, 5	1, 5, 3, 5	10	70°	B
100, 125		3, 5, 10			60°, 70°	
150, 175, 200	25, 38	3, 5, 10, 12	3, 5		45°, 60°, 70°	

TYPE 11C9

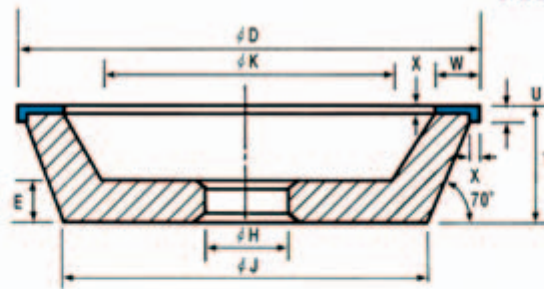

D	T	W	X	U	E	BOND
75, 100, 125	25, 30	5, 10	2, 3	5, 6	10	B, M
150, 175, 200	38	5, 10, 15		6, 8		
250						

TYPE 11V9

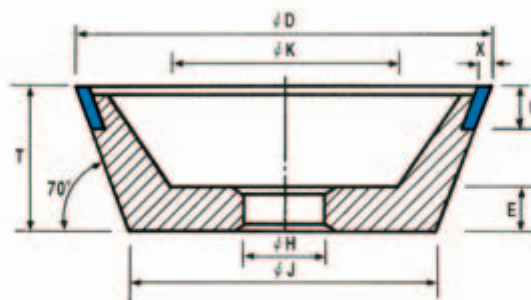

D	T	U	X	E	BOND
75	30	6 - 10	2, 3	10	B, M
100	30, 35				
125, 150					

# Wheel Availability

## TYPE 11Y9

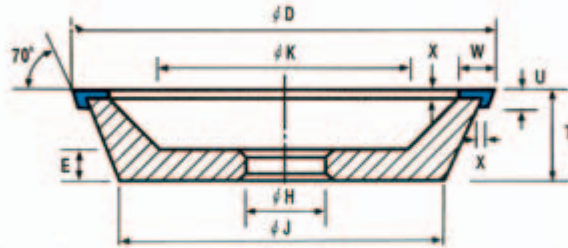

D	T	W	X	U	E	BOND
75, 100, 125	25, 38	5, 10	2, 3	5, 6	10	B, M
150, 175, 200	38	5, 10, 15		6, 8		
250						

## TYPE 12A2

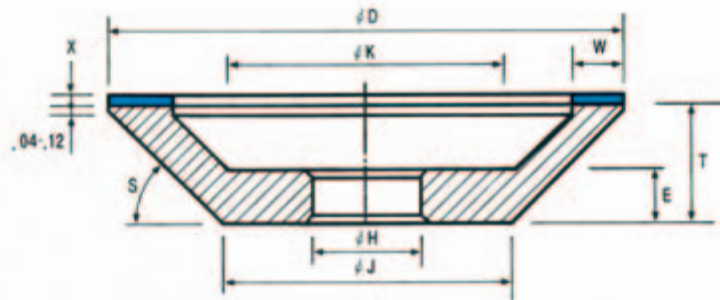

### (S=45°)

D	T	W	X	E	BOND
75, 100, 125	20	3, 5	1.5, 3	6	B, M
			3		V
150	25	5, 10, 13	1.5, 3, 5	10	B, M
			3, 5		V
175, 200	30	5, 10 15, 20, 25	1.5, 3, 5	10	B, M
250, 300			3, 6		B, M, V

### (S=20°)

D	T	W	X	E	BOND
75, 100	13	3, 5	1.5, 3	6	B, M
			3		V
125	20	3, 5, 10	1.5, 3	10	B, M
			3		V
150, 175	25	5, 10, 15	1.5, 3	10	B, M
200, 250			3, 5		B, M, V



# Wheel Availability

TYPE 12V4

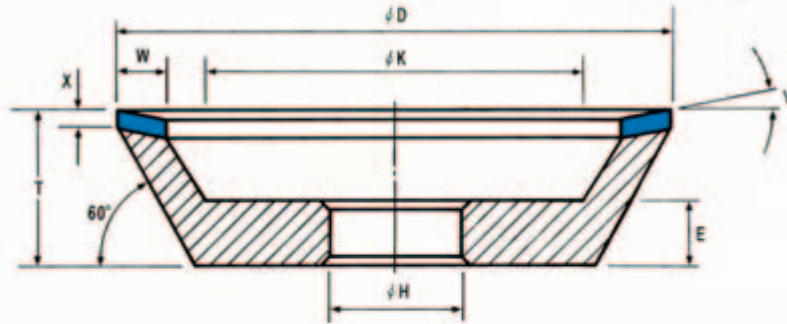

D	T	W	X	E	V	BOND
40	25	3	3, 5	10	10°	B
50, 75					20°	
100, 125, 150	40	3, 5				

TYPE 12V9

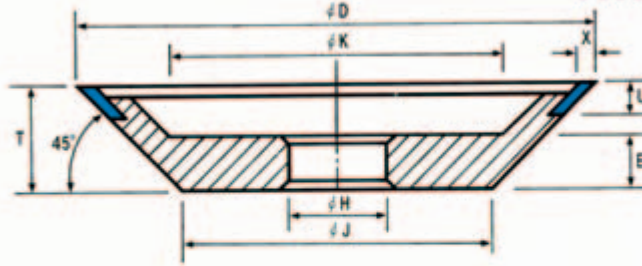

D	T	U	X	E	BOND
75, 90	20	5, 10, 12	1, 5, 3	10	B
100	22				
125, 150, 175, 200	25				

TYPE 14A1



D	T	X	U	BOND
75, 100, 125	10	3	1, 5	B, M
	13, 25	3, 5	3, 5, 10	B, M, V
150	10	5	1, 5	B, M
	13, 25	3, 5	3, 5, 10	B, M, V
			13 - 20	
25, 30	3 - 20			
175, 200, 250	25, 30	3, 5	10 - 20	B, M, V
300, 350, 400			10 - 20	
450, 500, 550, 600	35, 50		25 - 30	



# Wheel Availability

## TYPE 14EE1

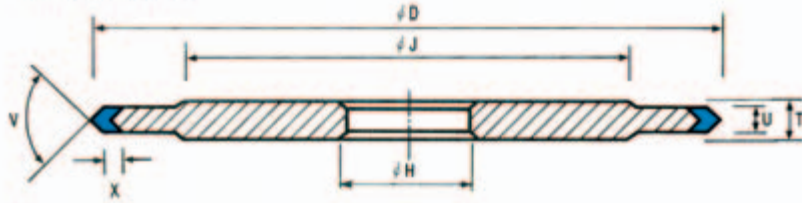

D	T	U	X	V	BOND
75, 100	15, 22, 25	3, 5	3	30' & larger	B, M
		10		45' & larger	
125, 150	25, 30	13		60' & larger	
		20		90' & larger	
175	15, 22, 25	10		45' & larger	
		13		60' & larger	
200, 250, 300	22, 25	5, 10, 13	90' & larger		
		10 - 25	60' & larger		
350, 400	30 - 40	13 - 25	90' & larger		

## TYPE 14U1

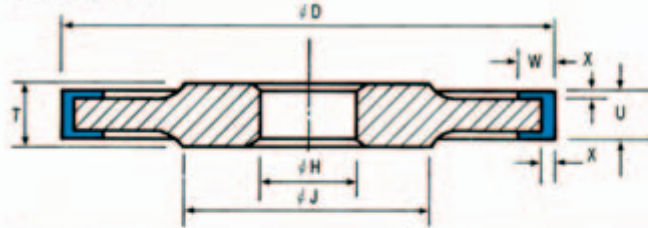

D	T	W	X	U	BOND
100, 125	15, 20, 22	3, 5, 10	3	10	B, M
150, 175	22, 25	5, 10, 15			
		200, 250			
300, 350	10, 15, 20				

# Wheel Availability

## TYPE 1A1W

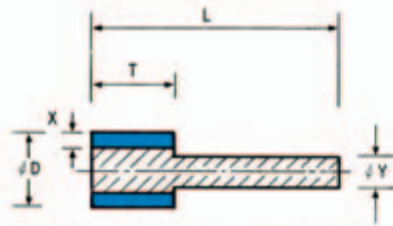

D	T	X	BOND
5	3, 5	1,5	B, M, V
		solid	B, M
8	5, 8, 10	1,5	B, M, V
		solid	B, M
10, 12	5, 10, 12	2, 3	B, M, V
		solid	B, M
15, 20, 25	5, 10, 12, 15	2, 3	B, M, V
		solid	B, M
25, 30, 35, 40	5, 10, 12	3	B, M, V
	15, 20, 25	solid	B, M

## TYPE HH1



L	W	X	T	L <sub>1</sub>	BOND
120	10	1,5, 3	11,5, 13	40	B

L<sub>1</sub>: Length of Abrasive Section

## TYPE HMF



L	W	X	R	BOND
25 - 100	3, 5, 6	3, 6	specify	B, M, V
			flat	

## TYPE PELLET

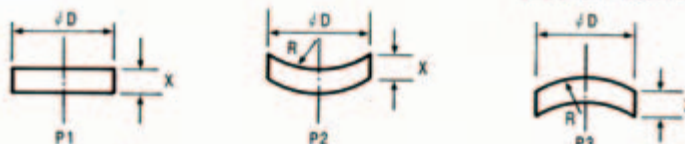

D	X	BOND
10 - 25	3, 5, 6	M

# Relation between the grit size of superabrasive and surface roughness

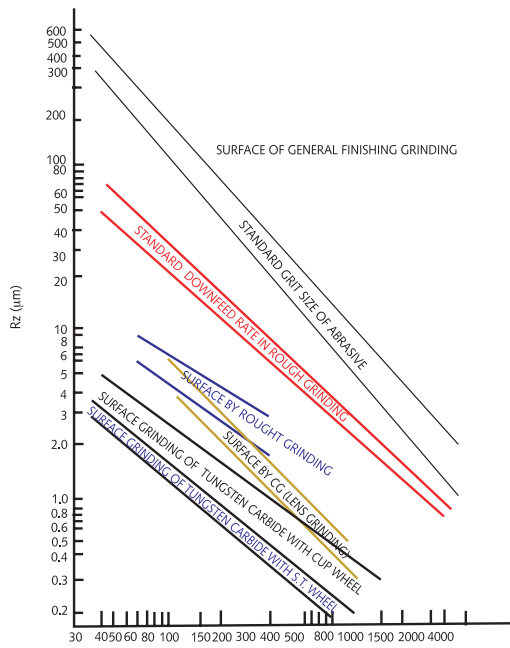

Fig. 1. MESH SIZE AND SURFACE ROUGHNESS

## FORMULA OF ABRASIVE & SURFACE

$$(1) \text{ SIZE}(\mu) \approx \frac{15,000}{M} \quad (M : \text{MESH SIZE})$$

$$(2) \text{ SURFACE ROUGHNESS}(R_{\text{max}}) \approx \frac{\text{SIZE}(\mu\text{m})}{x}$$

## QUALITY OF MATERIAL

X = 50 HIGH SPEED STEEL

X = 25 ALLOY STEEL

X = CAST IRON

IT WILL ACTUALLY BE MUCH COARSER THAN ABOVE MENTIONED.

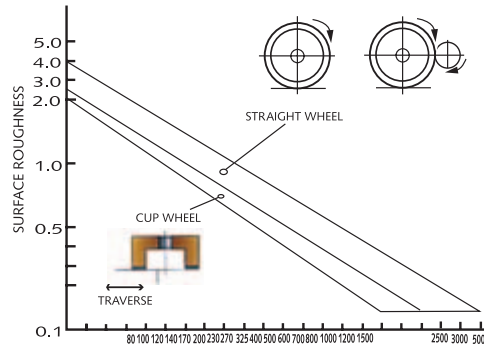
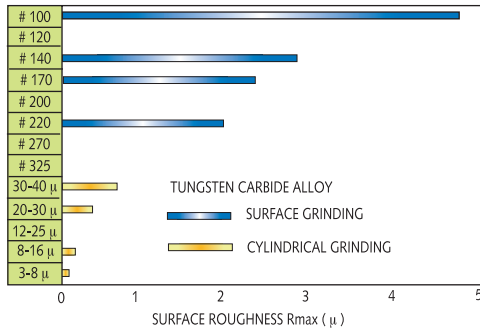

Fig. 2. DIFFERENCE OF SURFACE ROUGHNESS IN ACCORDANCE WITH THE SHAPE OF WHEEL



## SURFACE GRINDING

SPEC.	175D x 6T (1A1) SDC * P75B
PERIPHERAL SPEED	1500 m/min
TABLE SPEED	10 m/min
CROSS FEED	2 mm/PASS
DOWN FEED	20 μm
SPARK OUT	2 TIMES
COOLANT	W2 ( x 50)

## CYLINDRICAL GRINDING

SPEC.	300D x 15T (1A1) SDC * P75B
PERIPHERAL SPEED	2 200 m/min
TABLE SPEED	50 m/min
CROSS FEED	0.4 mm/PASS
DOWN FEED	2.5 ~ 5 μm
SPARK OUT	2 ~ 4 TIMES
COOLANT	W2 ( x 50)

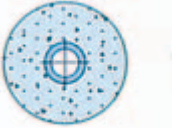

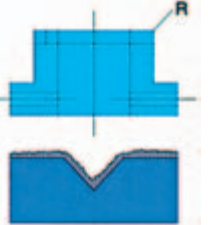
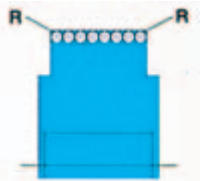
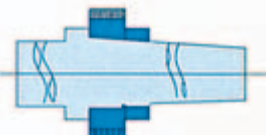

Fig. 3 = DIAMOND GRIT SIZE & SURFACE ROUGHNESS

Cf. There is not big difference between surface and cylindrical grinding in case of fine finish

TABLE 1. CONVERSION TABLE OF SURFACE ROUGHNESS

R max. (μm)	Ra (μm)	Rrms (μm)	Rz (μm)	Rrms (μm)
0.1	0.02	0.02	0.1	1
0.2	0.03	0.04	0.2	2
0.3	0.05	0.06	0.3	3
0.4	0.07	0.08	0.4	4
0.5	0.09	0.10	0.5	5
0.6	0.10	0.11	0.5	6
0.7	0.12	0.13	0.7	7
0.8	0.14	0.15	0.7	8
0.9	0.15	0.17	0.8	9
1.0	0.17	0.19	0.9	10
1.2	0.20	0.23	1.1	12
1.4	0.24	0.27	1.3	14
1.6	0.27	0.30	1.4	16
1.8	0.31	0.34	1.6	18
2.0	0.34	0.38	1.8	20
2.4	0.41	0.46	2.2	24
2.8	0.48	0.53	2.5	28
3.2	0.54	0.61	2.8	32
3.6	0.61	0.76	3.2	36
4.0	0.68	0.76	3.6	40
4.5	0.77	0.86	4.1	45
5.0	0.85	0.96	4.5	50
5.5	0.94	1.05	5.0	55
6.0	1.02	1.14	5.4	60
7.0	1.19	1.33	6.3	70
8.0	1.36	1.52	7.2	80
9.0	1.53	1.71	8.1	90
10.0	1.70	1.90	9.0	100

# Truing and dressing of grinding wheels

METHOD	TRUING WHEEL				OPERATION SYSTEM	CHARACTERISTIC	
	SHAPE	SPECIFICATION					
		GRIT SIZE	BOND				
HOW TO USE CONVENTIONAL GRINDING STONE	G.C. STONE		# 60 ∩ # 400	V	FIXED	<ol style="list-style-type: none"> <li>To grind the workpiece by making the broken pieces of GC directly touch. It without any special equipment for it.</li> <li>Dressing can be done during truing operation.</li> <li>It can be simply done by manual operation but the performance is worse than other ways.</li> </ol>	
	PARALLEL TYPE		# 80 ∩ # 400	V	LINKAGE	<ol style="list-style-type: none"> <li>To be used widely and by hand.</li> <li>Dressing can be done during truing operation.</li> </ol>	
					PERIPHERAL OPERATION	<ol style="list-style-type: none"> <li>Lower risk when being touched by Abrasives than that of Linkage.</li> <li>Truing and Dressing can be done easily.</li> </ol>	
HOW TO USE DIAMOND TOOLS	DIAMOND DRESSER	SINGLE		0.5 ∩ 1.Oct	M	FIXED	<ol style="list-style-type: none"> <li>Operation is available by existing dressing equipment and by hand.</li> <li>It is widely used.</li> <li>Good for complicated shape like R-shape or screw shape but tool life is short.</li> </ol>
		IMPRE		# 80 ∩ # 200	M		<ol style="list-style-type: none"> <li>Same as above.</li> <li>Because edge of dresser is flat (around 5 Ø). It is not suitable for truing of flange shape.</li> </ol>
		BLOCK		# 60 ∩ # 80	P		<ol style="list-style-type: none"> <li>Because of excellent exposure of Diamond, quick and precise truing is available.</li> <li>Instead, tool life is short.</li> </ol>
				# 80	ST		It is effective for truing of Metal bonded CBN grinding wheel and make it easy dressing after truing.
	ROLLER			M	PERIPHERAL OPERATION	<ol style="list-style-type: none"> <li>It can be used for truing of Resinoid and Vitrified CBN grinding wheel.</li> <li>In case of Vitrified CBN grinding wheel, Dressing and Truing can be done at the same time.</li> <li>It shows excellent surface.</li> </ol>	
	ABRASIVES		# 60 ∩ # 80	P	PERIPHERAL OPERATION	<ol style="list-style-type: none"> <li>Truing lead time is very short and it does not need special equipment for it.</li> <li>Tool life is short.</li> </ol>	
			# 60 ∩ # 80	M		It shows similar performance with electroplated Roller Dresser but the tool life is too long because of multi layers of Diamond grits.	
# 60 ∩ # 100			ST	It is much more effective for truing of Metallic CBN grinding wheel and make it easy dressing after truing as well.			
HOW TO USE CRUSHROLL		WORKPIECE MATERIAL	HARDNESS	LINKAGE	<ol style="list-style-type: none"> <li>It is recommendable for Plunge typed truing of crushable bond and Vitrified CBN grinding wheel.</li> <li>Precise plunge typed truing is available and dressing can be done during truing operation at the same time.</li> </ol>		
		SKD-11	HRc 60				

# Factors of grinding efficiency of the wheels

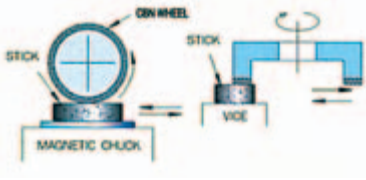
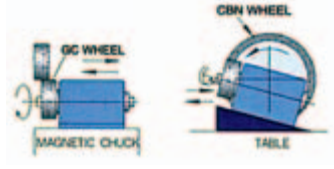
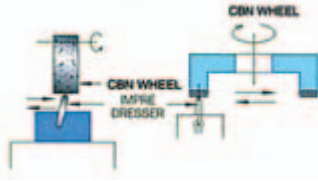
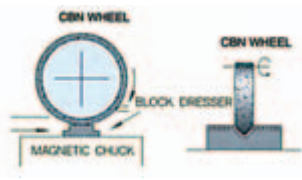
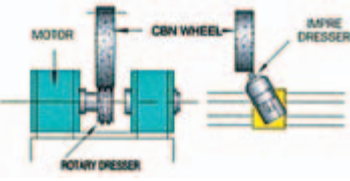
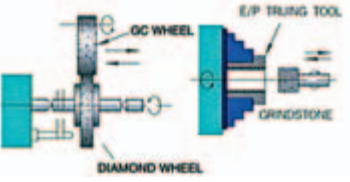
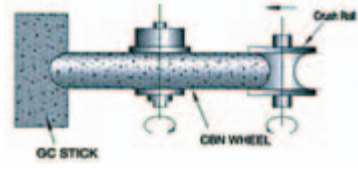
DIAMOND / CBN WHEEL						HOW TO DO	REMARK
TYPE		BOND					
ST	CUP	B	M	V	P		
●	●	●	●	●	●		1. The grit size of GC stone is determined in accordance with the grit size of CBN wheel. 2. Low rpm and small amount of coolant are preferable.
●	●	○	○	×	×		1. In case of using linkage, slating angle should be as followings: Brake type = 15° ~ 25° Free type = 30° ~ 45°
●	●	▲	×	▲	×		1. Infeed should be determined according to condition of the wheel. (2 ~ 10 μm) 2. Recommendable peripheral speed is 500 ~ 1,000 m/min.
●	×	●	×	○	×		1. Peripheral speed of CBN wheel should be 1,000 m/min with enough coolant for suitable work. 2. Dressing should be determined according to vibration of the wheel.
●	●	●	×	○	×		1. Profile tolerance of mounting surface of Roller Dresser should be below 3 μm. 2. Infeed of Roller Dresser should be controlled as following: Traverse type : 0.002 ~ 0.005mm Plunge type : 0.001 ~ 0.005mm
●	×	●	×	○	×		1. RPM of truing tool should be ranged from 150 to 300 and Up-Cutting method is required when truing. 2. Infeed rate should be 5 ~ 10μm and enough coolant is required when truing. 3. Truing should be done by both sides, with controlling proper spark-out.
●	×	▲	○	○	×		1. There are two methods: one is to use its own wheel, the other is to coordinate the devices to the machine.

○ OPTIMUM    ● GOOD    ▲ NORMAL    × BAD



## To achieve the best grinding performance of Diamond grinding wheel

*Diamond is the hardest material and has a good abrasion resistance, it is easily broken on impact. It also becomes weak under high temperatures and begins to oxidize at about 600°C.*

**Please consider the following checkpoints in order to achieve the best grinding performance of the wheel.**

### 1. Peripheral speed ( $\pi DN/1000$ )m/min

For general grinding abrasives, peripheral speed is over 300 m/min. However, increasing the peripheral speed of a diamond grinding wheel is not always efficient. The peripheral speed of a Diamond grinding wheel changes according to the working condition and has a great influence on its grinding efficiency.

It is almost impossible to set peripheral speed at once, but we recommend you to follow the general information as below-mentioned:

Resinoid Bond;

Wet grinding : 1,000 ~ 1,800 m/min

Dry grinding : 700 ~ 1,000 m/min

Metallic Bond;

Wet grinding : 800 ~ 1,500 m/min

Dry grinding : 600 ~ 1,000 m/min

Please, reduce the speed in the case of dry and deep grinding.

### 2. Feed Rate or Grinding Pressure

Generally a deeper grinding is more efficient, but if you use the Diamond grinding wheel over its capacity, it will extremely shorten the life of a Diamond grinding wheel.

Please follow the information to maximize the tool life as follows:

# 100 ~ 120 : 0.025mm

# 140 ~ 200 : 0.012mm

smaller than # 230 : less than 0.01mm

### 3. Table Speed and cross feed

Table speed is determined by peripheral speed and feed rate, but 5 ~ 10 m/min is preferable in the case of wet surface grinding. And low table speed is preferable in the case of simultaneous grinding of workpiece with 2 different materials welded, interrupted, and dry grinding by Cup wheel. For back and forth feed of surface grinding it is better to follow 1/5 ~ 1/10 of wheel width.

The degree of work done by feed rate, cross feed and table speed is often called Material-removal rate or Grinding ratio. If you increase material-removal rate, productivity will increase but grinding ratio will decrease.



## To achieve the best grinding performance of Diamond grinding wheel

### 4. Grinding fluids

With supply of coolant, it is possible to have preciseness and finish of the workpiece, thus having much influences on grinding wheel capabilities.

It is better to focus on the cooling and rinsing of grinding wheels when you choose the kind of coolant, and carefully determine the effective amount of coolant and supply to the grinding surface directly.

Pure oil is the best coolant in terms of rinsing, but you can use synthetic emulsion fluid if pure oil not available.

Supplying coolant to the exact grinding point is much more efficient than to the body of the wheel or workpiece.

### 5. Preciseness of machine

Because a diamond is very weak and easily broken on impact, it is very important to mount the wheels to the axis accurately for efficient grinding performance. For excellent grinding capabilities, the stiffness and rigidity of machine are basically required. With the shake or vibration of the machine, diamond grits could be easily broken on impact and abnormal abrasion of the wheels could be resulted.

### 6. Loading and vibration

As the sharpness of diamond grits is getting blunt due to the chip of workpiece during grinding process, it is necessary that the grinding wheel should be used with diamond exposed sharp to keep grinding efficiency better. If grit is damaged by aggressive power or bond loose the grip, it is recommended to turn the switch off and to put GC stick on the grinding surface of the wheel at a low speed. Turning it on and off repeatedly could be effective in getting rid of small loading of the wheel.

Diamond grinding wheels are basically designed to protect the wheel loading with the chip of workpiece. Therefore, using the wheels without the chip and finding the exact cause of the loading is the best way to increase grinding efficiency. For more details, please refer to "Truing and Dressing of grinding wheels".

# To achieve the best grinding performance of CBN grinding wheel

## 1. Peripheral speed of conventional abrasive ( $\pi DN/1000$ )m/min

In CBN resin bonded grinding wheels, generally, high peripheral speed improves tool life in wet grinding, but can lead to burning in dry grinding, so it is recommended to use it under 1500 m/min in dry grinding.

In CBN metal bonded grinding wheels in internal grinding with deep infeed and slow table speed, high peripheral speed like 2000 ~ 3000 m/min leads to good results.

Property	Resin bond	Metal bond
Wet	1500 ~ 2500	800 ~ 1500
Dry	800 ~ 1500	Applicable in some

## 2. Infeed and table speed

Not fixed in conditions. Refer to the following numerical values of resin bonded wheels of which the grit is bigger than #200.

Surface grinding	Infeed x cross feed x table speed	1.9 cm <sup>3</sup> /min
Cylindrical grinding	Workpiece's outdiameter x infeed x table speed	3.1 cm <sup>3</sup> /min
Internal grinding	Work piece's bore x work piece's length x Grinding time Grinding time : sec (60 sec/min)	1.3 cm <sup>3</sup> /min
Tool grinding	Infeed x work piece's grinding width x table speed	0.4 cm <sup>3</sup> /min

Over 0.02 mm/min of infeed is recommended in general grinding except for bore grinding, but in finer grits than #230, appropriate infeed should be selected. It is recommended to use metal bonded wheels in rough conditions.

## 3. Grinding fluid

CBN grits are so much influenced by coolant in high temperature that they easily become dull without coolant. Pure oil is the most proper coolant for CBN grinding points, which is an important factor to keep the tool life longer.

## 4. Truing and dressing

CBN wheels can have a vibration problem due to tolerance between wheel flange bore and outdiameter of shaft although wheel is precisely balanced and processed to size at the factory. For more information, refer to "Truing and Dressing of grinding wheels".



## The optimal condition for peripheral speed & revolution per minute [RPM]

1. Even though a Diamond grinding wheel can be used at a high speed, excessive high speed can heat up Diamond grits and wear it out easily, which decreases the efficiency of a Diamond grinding wheel.
2. While Diamond grinding wheel shows excellent grinding ability at a high speed, the stiffness and rigidity of grinding machine are also factors that affect grinding performance.
3. Peripheral speed is concerned with the increase and the decrease of grinding load and low peripheral speed is generally more suitable for dry grinding than wet grinding.

Refer to the following table to choose proper peripheral speed.

BOND	DIA		CBN	
	DRY	WET	DRY	WET
METAL	500~700	700~1100	PARTIALLY APPLIED	800~1500
RESIN	700~1000	1000~1800	800~1500	1500~2500
VITRIFIED	700~1200	1200~1800	800~1200	1200~2400
ELECTROPLATED	700~1200	1200~2400	900~1400	1200~2400

$$v = \pi \times D \times N / 1000$$

$$V : (m/min)$$

$$D : DIAMETER (mm)$$

$$N : (rpm)$$

V (m/min) \ D (mm)	500	700	800	900	1000	1200	1400	1500	1800	2000	2400
10	15900	22300	25500	28600	31800	38200	44600	47700	57300	63700	76400
20	7960	11100	12700	14300	15900	19100	22300	23900	28600	31800	38200
30	5310	7430	8490	9550	10600	12700	14900	15900	19100	21200	25500
50	3180	4460	5090	5730	6370	7640	8910	9550	11500	12700	15300
75	2120	2970	3400	3820	4240	5090	5941	6370	7640	8490	10200
100	11590	2230	2550	2860	3180	3820	4460	4770	5730	6370	7640
125	1270	1780	2040	2290	2550	3060	3570	3820	4580	5090	6110
150	1060	1490	1700	1910	2120	2550	2970	3280	3820	4240	5090
175	910	1270	1460	1640	1820	2180	2550	2730	3270	3640	4370
200	800	1110	1270	1430	1590	1910	2230	2390	2860	3180	3820
250	640	890	1020	1150	1270	1530	1780	1910	2290	2550	3060
300	530	740	850	950	1060	1270	1490	1590	1910	2120	2550
350	450	640	730	820	910	1090	1270	1360	1640	1820	2180
400	400	560	640	720	800	950	1110	1190	1430	1590	1910
500	320	450	510	570	640	760	890	950	1150	1270	1530



# diprotex

9 bis, chemin des Prés ZIRST - 38944 Meylan - FRANCE  
Tél. + 33 (0)4 76 41 14 81 - Fax + 33 (0)4 76 90 16 54  
E-mail : [diprotex.sa@diprotex.com](mailto:diprotex.sa@diprotex.com)

