

HOLEMAKING TOOLS



About GESAC

Xiamen Golden Egret Special Alloy Co., Ltd. (GESAC), founded in 1989, is a Sino-foreign joint venture with national high-tech, affiliated with XTC, which is one of six major rare earth groups in China. GESAC is committed to research & development, production and professional solutions providing of high-quality tungsten powder materials, cemented carbide, precision cutting tools and other tungsten products. Up to now, GESAC has become world-famous manufacturer and supplier of tungsten powder, cemented carbide and precision cutting tools products.

With the Integrated Product Development of complete tungsten industry chain, as well as a pragmatic and innovative management concept, GESAC has always maintained a strong momentum of development, providing the cost effective tungsten powder products and services for global users, offering the excellent products and perfect solutions for solving high hardness, high temperature resistance and wear resistance topics. Our brand "Golden Egret" has become one of the leading brand in the market, enjoying famous reputation in more than 40 countries and regions.

GESAC owns three production bases, three overseas sales branches and one R&D center. We undertook and completed several development programs independently, including the "National Science and Technology Support Programs", the "National Torch Program Projects", and the "National Key Projects" and so on. GESAC was awarded as "Key Enterprise for Strategic Emerging Industry", "Innovative Enterprise" and "Enterprise with Advanced Technology".



Product Chain

GESAC has a complete tungsten product chain from tungsten ore to tungsten powder, cemented carbide products and cutting tools.

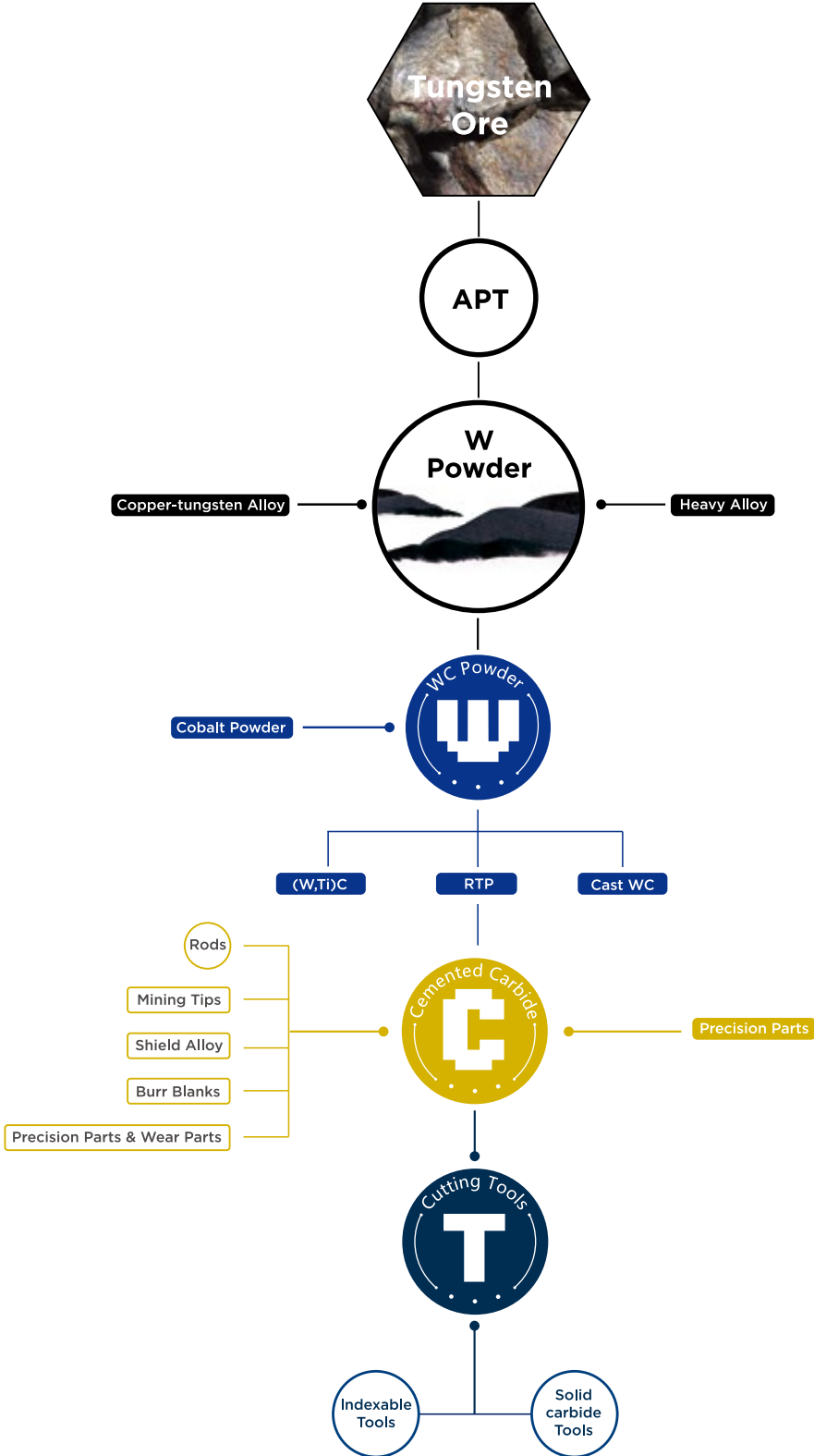

Contents

Holemaking tools index	004		
New Products	015		
Solid Carbide Drills		A	
D918S High Performance Twist Drills For Steel	017		
D968S High Performance Twist Drills for Stainless Steel	021		
D938 Twist Drills for Steel	025		
D918 Twist Drills for General Purpose	046		
D928 Twist Drills for Cast Iron	056		
D998 Twist Drills for Hardened Steel	060		
D713 Straight Flute Drills for Cast Iron	061		
D101/D102/D103 NC Centre Drills	063		
D612 Triple-angle Drills for Composite Material	066		
D973 Twist Drills for Composite and Metal	067		
D573 Drills for Composite and Metal	068		
Indexable Drill		B	
GSD Spade Drills	087		
GD600/GD602 DeepHole Indexable Drills	095		
GHD Indexable Drills	101		
			C
		Finishing Tool	
		RB RB Rough Boring Tool	121
		LRB Rough Boring Tool with big diameter	126
		FB Finishing Boring Tool	127
		LFB Finish Boring Tool with big diameter	129
		SFB Micro-Finish Boring Tool	131
		GBJ16 Micro-boring Tool	132
		GBH2084 Micro-boring Tool	133
		Boring tool shank and Spare parts	135
		R733-C Reamer for Composite Material	141
		R733-CM Reamer for Composite and Metal	142
		Threading Tool	D
		T100 High performance Helical Flute tap for steel	146
		Appendix	E
		Workpiece Material Table	149
		The Structure of Shank—DIN Standard	150
		Cutting Calculations and Definitions	151
		Service of Tool Regrinding	153









































































































A

SOLID CARBIDE DRILLS



GESAC

















































































Content of Drills Series

Drills Series	Description and profile	Point Angle	Shank Type	Coating	Drilling Depth	Coolant Type / form	Tool Type	Dimension Range	Hole accuracy class	Dimension Page	Cutting Parameters Page
D918S	3D External Cooling, Twist Drill 	140°						D3~D20	IT9-10	P017	P069
	3D Inner Cooling, Twist Drill 	140°						D3~D20	IT9-10	P018	P069
	5D External Cooling, Twist Drill 	140°						D3~D20	IT9-10	P019	P069
	5D Inner Cooling, Twist Drill 	140°						D3~D20	IT9-10	P020	P069
D968S	3D External Cooling, Twist Drill 	140°						D3~D20	IT9-10	P021	P071
	3D Inner Cooling, Twist Drill 	140°						D3~D20	IT9-10	P022	P071
	5D External Cooling, Twist Drill 	140°						D3~D20	IT9-10	P023	P071
	5D Inner Cooling, Twist Drill 	140°						D3~D20	IT9-10	P024	P071
D101	90° NC Centre Drill 	90°						D5~D20		P063	P077
D102	120° NC Centre Drill 	120°						D5~D20		P064	P077
D103	145° NC Centre Drill 	145°						D5~D20		P065	P077
D918	3D External Cooling, Twist Drill 	140°						D3~D20	IT9-10	P047	P079
	3D Inner Cooling, Twist Drill 	140°						D5~D16	IT9-10	P049	P079
	5D External Cooling, Twist Drill 	140°						D3~D20	IT9-10	P051	P079
	5D Inner Cooling, Twist Drill 	140°						D5~D16	IT9-10	P054	P079
D938	3D External Cooling, Twist Drill 	140°						D3-D20	IT9-10	P026	P073
	3D Inner Cooling, Twist Drill 	140°						D3-D20	IT9-10	P029	P073
	5D External Cooling, Twist Drill 	140°						D3-D20	IT9-10	P033	P073

● Most Suitable ○ Suitable

工件材料																													
P			M			K			N				S		H														
1	2	3	4	5	6	7	1	2	3	1	2	3	4	5	1	2	3	4	1	2	3								
Carbon Steels, Alloy Steels				Alloy Steels, Tool Steels		PH and Ferrite/ Martensitic Stainless	Stainless Steel			Cast Iron, Ductile Cast Iron		High Alloy Cast Iron		Wrought Aluminium Alloys, Cast Aluminium Alloys		Cast Aluminium Alloys		Copper Alloys		Composite Material		Heat Resistant Super Alloys		Titanium Alloys		Hardened Steels		Hardened Steels	
<35HRC				35-48HRC						<35HRC		35-45HRC		Si < 12%		Si > 12%		<200HB				<450HB		<400HB		45-55HRC		55-60HRC	
○	○	○	○	○	○	○	○	○	○																				
○	○	○	○	○	○	○	○	○	○																				
○	○	○	○	○	○	○	○	○	○																				
○	○	○	○	○	○	○	○	○	○																				
○							○																						
○							○					○	○	○									○	○					
○							○																						
○							○					○	○	○									○	○					
○	○	○	○				○				○	○																	
○	○	○	○				○				○	○																	
○	○	○	○				○				○	○																	
○	○	○	○				○				○	○																	
○	○	○	○				○				○	○																	
○	○	○	○				○				○	○																	
○	○	○	○				○				○	○																	

Content of Drills Series

Drills Series	Description and profile	Point Angle	Shank Type	Coating	Drilling Depth	Coolant Type / form	Tool Type	Dimension Range	Hole accuracy class	Dimension Page	Cutting Parameters Page
D938	5D Inner Cooling, Twist Drill 	140°					D938-A5C	D3-D20	IT9-10	P037	P073
	8D Inner Cooling, Twist Drill 	140°					D938-A8C 	D3-D16	IT9-10	P041	P075
	12D Inner Cooling, Twist Drill 	135°					D938-A12C 	D3-D12	IT9-10	P044	P075
	15D Inner Cooling, Twist Drill 	135°					D938-A15C 	D3-D12	IT9-10	P045	P075
D928	3D External Cooling, Twist Drill 	140°					D928-A3N	D3~D20	IT9-10	P056	P081
	3D Inner Cooling, Twist Drill 	140°					D928-A3C	D5~D20	IT9-10	P057	P081
	5D External Cooling, Twist Drill 	140°					D928-A5N	D3~D20	IT9-10	P058	P081
	5D Inner Cooling, Twist Drill 	140°					D928-A5C	D5~D20	IT9-10	P059	P081
D998	3D External Cooling, Twist Drill 	140°					D998-Y3N	D4~D16	IT9-10	P060	P083
D713	5D External Cooling Straight Flute Drills for Cast Iron 	130°					D713-A5N	D4~D20	IT8-9	P061	P084
	5D Inner Cooling Straight Flute Drills for Cast Iron 	130°					D713-A5C	D4~D20	IT8-9	P062	P084
D612	Triple-angle Drills 	118°					D612-Y3N	D2.49-D7.94		P066	P085
D973	5D External Cooling, Twist Drill 	120°					D973-Y5N	D2.5-D8.0		P067	P085
D573	3Flute external Coolant core drills 						D573-Y3N	D4-D9.3		P068	P085
R733-C	Left Hand Helix Reamer 						R733-C	D3.26-D12.7		P141	P144
R733-CM	Left Hand Helix Reamer 						R733-CM	D3.26-D12.7		P142	P144

● Most Suitable ○ Suitable

工件材料																	
P			M	K		N				S		H					
1	2	3	4	5	6	7	1	2	3	1	2	3	4	1	2	3	
Carbon Steels, Alloy Steels				Alloy Steels, Tool Steels	PH and Ferrite/Martensitic Stainless		Stainless Steel	Cast Iron, Ductile Cast Iron	High Alloy Cast Iron	Wrought Aluminium Alloys, Cast Aluminium Alloys	Cast Aluminium Alloys	Copper Alloys	Composite Material	Heat Resistant Super Alloys	Titanium Alloys	Hardened Steels	Hardened Steels
<35HRC				35-48HRC				<35HRC	35-45HRC	Si<12%	Si>12%	<200HB		<450HB	<400HB	45-55HRC	55-60HRC
○	○	○	○	○	○			○	○								
○	○	○	○	○	○	○	○	○	○								
○	○	○	○	○	○	○	○	○	○								
○	○	○	○	○	○	○	○	○	○								
○							○	○									
○							○	○		○	○						
○							○	○									
○							○	○		○	○						
○							○	○									
○													○				
○	○	○	○	○	○	○				○	○				○		
○	○	○	○	○	○	○				○	○		○	○	○		
													○				
○				○	○	○	○			○	○		○	○	○		

Content of Drills Series

Drills Series	Description and profile	Shank Type	Shank Type	Drilling depth	Tool Type	Dimension Range	Hole accuracy class	Dimension Page	Cutting Parameters Page	
GSD Spade Drills	MCMG Spade insert			GM3225				P089		
	GSD The Lateral Fixation Type Flange Shank and Helical Flute Holder							P090	P94	
	GSD-S The Lateral Fixation Type Flange Shank and straight Flute Holder			1D-26D				P091		
	GSD-FMT Morse taper shank and Helical Flute Holder			2D-12D				P092		
GHD Indexable Drills	QPMG Drilling insert			GA4230 GS4130				P115		P117
	GHD Drilling holder			2D-5D	GHD	D14-D51	IT12-13	P101		
SPMG /WCMT Drilling insert	SPMG Drilling insert			GA4230 GS4130	SPMG		IT12-13	P116		
	WCMT Drilling insert			GA4230	WCMT		IT12-13	P116		
GD600 Screw Locking deep drill	GD600 DeepHole Indexable Drills			GA4230 GM3225	MAX 100D	BTA ejector drilling head	D38-D107	P096	P098	
GD602B Brazed deep drill	GD602B DeepHole Indexable Drills				MAX 100D	GD602B	D15.6-D36.2	IT9	P099	P100
RB/LRB Rough Boring Tool	RB Rough Boring Tool				MAX 7D	RB	D20-D170	IT8-9	P121	P143
	LRB Rough Boring Tool with big				MAX 4D	LRB	D148-D1260	IT8-9	P126	
FB/LFB Finish Boring Tool	FB Finish Boring Tool Accuracy of adjustment0.01mm				MAX 7D	FB	D20-D203	IT7-8	P127	
	LFB Finish Boring Tool with big diameter Accuracy of adjustment0.01mm				MAX 4D	LFB	D148-D1475	IT7-8	P129	
SFB Micro-Finish Boring Tool	Accuracy of adjustment0.002mm				MAX 7D	SFB	D29-D150	IT7-8	P130	
GBJ/GBH Micro-Finish Boring Tool	Accuracy of adjustment0.001mm					GBJ	D6-D50	IT7-8	P132	
	Accuracy of adjustment0.01mm					GBH	D8-D280	IT7-8	P133	

● Most Suitable ○ Suitable

	工件材料																	
	P			M	K		N				S	H						
	1	2	3	4	5	6	7	1	2	3	1	2	3	4	5	1	2	3
	Carbon Steels, Alloy Steels	Alloy Steels, Tool Steels	PH and Ferrite/ Martensitic Stainless	Stainless Steel	Cast Iron, Ductile Cast Iron	High Alloy Cast Iron	Wrought Aluminium Alloys, Cast Aluminium Alloys	Cast Aluminium Alloys	Copper Alloys	Composite Material	Heat Resistant Super Alloys	Titanium Alloys	Hardened Steels	Hardened Steels				
<35HRC	35-48HRC			<35HRC	35-45HRC	Si<12%	Si>12%	<200HB		<450HB	<400HB	45-55HRC	55-60HRC					
	○			○	○													
	○			○	○													
	○			○	○													
	○			○	○													
	○			○	○													
	○			○	○													
	○			○	○	○	○	○	○			○						
	○			○	○	○	○	○	○			○						
	○			○	○	○	○	○	○			○						
	○			○	○	○	○	○	○			○						
	○			○	○	○	○	○	○			○						
	○			○	○	○	○	○	○			○						
	○			○	○	○	○	○	○			○						
	○			○	○	○	○	○	○			○						
	○			○	○	○	○	○	○			○						
	○			○	○	○	○	○	○			○						

Solid Carbide Drills Identification System

D938 —



Workpiece Material	①Drills Series	
Steel, Cast Iron, Non-steel Material	D101	Straight Shank 90°NC Centre Drills
	D102	Straight Shank 120°NC Centre Drills
	D103	Straight Shank 145°NC Centre Drills
Steel	D918	Twist Drills for General Purpose
	D938	Twist Drills for Steel
Stainless Steel	D968S	Twist Drills for Stainless Steel
Cast Iron	D928	Twist Drills for Cast Iron
Hardened Steel	D998	Twist Drills for Hardened Steel
Cast Iron	D713	Straight Flute Drills for Cast Iron
Composite Material	D612	Triple-angle Drills for Composite Material
	R733-C	Reamer for Composite Material
Composite and Metal	D973	Twist Drills for Composite and Metal
	D573	Core Drills for Composite and Metal
	R733-CM	Reamer for Composite and Metal

A 5 C – 1200

②

②ShankType	
A	DIN6535HA
E	DIN6535HE
B	DIN6535HB
Y	Continuous Parallel Shank
M	Mose Shank

③

③Drilling Depth	
3	Drilling Depth ≤ 3D
5	Drilling Depth ≤ 5D
8	Drilling Depth ≤ 8D
A	Drilling Depth ≤ 10D
M	90°Point Angle
N	120°Point Angle
P	145°Point Angle

④

④Coolant Type	
C	Internal Coolant
N	External Coolant

⑤

⑤Drill Diameter	
0325	Dia: Φ3.25
0600	Dia: Φ6.00
1200	Dia: Φ12.00

Series Introduce

D918 Twist Drills for General Purpose

- Suitable for drilling steel, stainless steel, cast iron, non-ferrous material.
- Stub chisel, excellent self-center capability.
- Curve point, smaller cutting resistance.
- Lip chamfer, higher feed rate, higher efficiency.



D938 Twist Drills for Steel

- Suitable for drilling of Steel ($\leq 48\text{HRC}$), Cast Iron.
- Unique cutting edge preparation to add strength to the cutting edge, and improve the drilling stability.
- New AlTiN-nano coating, superior wear resistance, longer tool life.
- Straight cutting edge, improves tool strength.

D928 Twist Drills for Cast Iron

- Suitable for drilling cast iron of automobile industry and other industries.
- Wave formed cutting lips provides lowered machining torque.
- Four margin design, improves hole wall quality and accuracy.
- Increased Drills point strength through optimized chisel edge.



D968S High Performance Twist Drills for Stainless Steel

- Suitable for high efficient drilling of stainless steel, carbon steel, alloy steel, heat-resistant alloys and titanium alloys and other materials.
- Unique bottom edge design with stronger chip breaking capacity and larger chip holding space.
- New substrate coating—superior toughness and wear resistance.
- Large groove design, with good chip evacuation performance.

Series Introduce

D998 Twist Drills for Hardened Steel

- Suitable for drilling hardened steel.
- Large core thickness, small helix angle, high rigidity and strength.
- X-shaped drills tip, excellent self-center capability.
- Radius drills point, excellent hole wall quality.



D713 Straight Flute Drills for Cast Iron

- Straight flute design, suitable for drilling cast iron.
- Four margin design, improve hole wall quality and accuracy.
- X-shaped drills tip, excellent self-center capability.

D101/D102/D103 NC Centre Drills

- Suitable for drilling the center hole and chamfer.
- Suitable for drilling steel, cast iron, aluminum alloys, copper alloy.



D973 Twist Drills for Composite and Metal

- Suitable for carbon fiber / glass fiber reinforced plastic and metal laminated board material manual hole.
- Suitable for aviation aluminum, titanium alloy, stainless steel metal materials.
- Double edge and self centering design increases process stability.
- Hole tolerance: $\pm 0.025\text{mm}$ ($\pm 0.001''$).
- Unique tip design reduces export burrs.
- Recommended with the use of drilling sleeve.

Series Introduce

D573 Core Drills for Composite and Metal

- Suitable for manual reaming of CFRP / GFRP and metal laminates
- Suitable for aviation aluminum, titanium alloy, stainless steel metal materials
- Three-blade structure and drill tip design to increase processing stability
- Recommended with the use of drilling sleeve
- Hole tolerance: $\pm 0.025\text{mm}$ ($\pm 0.001''$)



D612 Triple-angle Drill for Composite Material

- Suitable for all kinds of carbon fiber / glass fiber reinforced plastic manual drilling!
- The tool slot is designed for unidirectional and braided belt type CFRP
- The unique tip design ensures smooth and smooth drilling
- Cutting edge sharp can be processed out of excellent export / import quality
- Hole tolerance: $\pm 0.025\text{mm}$ ($\pm 0.001''$)



R733-CM Reamer for Composite and Metal

- Suitable for high precision manual reaming of CFRP / GFRP and metal laminates
- Suitable for hole geometric accuracy and processing roughness demanding reaming
- Double ladder design can effectively increase the scope of application
- Hole tolerance: $\pm 0.010\text{mm}$

R733-C Reamer for Composite Material

- Suitable for all kinds of carbon fiber / glass fiber reinforced plastic high precision manual hinge processing
- Suitable for hole geometric accuracy and processing roughness demanding reaming
- Double ladder design can effectively increase the scope of application
- Hole tolerance: $\pm 0.010\text{mm}$



New Products

D938 Series

12D-15D Deep-hole Inner Cooling Twist Drill

- Suitable for efficient drilling of Steel, Cast Iron and Stainless steel
- New substrate material, toughness and wear resistance of perfect balance
- Using AlTiN-nano coating and unique post-processing of coating
- Optimize the groove profile and design of drill point, With super self-centering Performance, chip breaking performance and good chip evacuation performance



D918S

High Performance Twist Drills for Steel

- Suitable for drilling mild Steel, Interrupted cutting, defective cooling condition and other severe working conditions.
- Curved edge design, balance tip strength and sharpness.
- New G form flute design, strengthens chip breaking performance and tool rigidity.
- New substrate and upgraded coating, contributes to higher flexibility for various drilling conditions and better universality



Application Summary of Solid Carbide Drills

ISO	GESAC Material Group	Internal Coolant Drilling					External Coolant Drilling		
		3*D	5*D	8*D	12*D	15*D	Chamfer/ centre hole	3*D	5*D
P	Carbon Steels, Alloy Steels (<35HRC)	D918 D938 D918S NEW	NEW	D938	NEW D938	NEW D938	D101 D102 D103	D918 D938 D918S	
	Alloy Steels (35-48HRC)								
	PH and Ferrite/Martensitic Stainless (<35HRC)								
M	Stainless Steel	D968S NEW	NEW	Developing	Developing		D968S		
K	Cast Iron, Ductile Cast Iron (<32HRC)	D928 D713	NEW	Developing	Developing		D928 D713		
	High Alloy Cast Cast Iron (35-45HRC)								
N	Wrought Aluminium Alloys, Cast Aluminium Alloys	D713	NEW	Developing	Developing		D713		
	Cast Aluminium Alloys (Si>12%)								
	Copper Alloys (<200HB)								
	Composite								
S	Heat Resistant Super Alloys (<450HB)	D968S					D968S		
	Titanium Alloys (<400HB)								
H	Hardened Steels (45-60HRC)						D998		
	Hardened Steels (60-65HRC)								

D918S-A3N NEW



High Performance 3D External Cooling Twist Drills For Steel

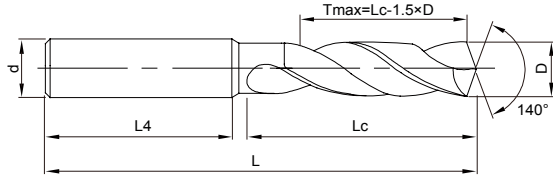

Tmax-Recommended Maximum Depth

Ordering Code	D(m7)	Lc	L4	L	d(h6)	Stock
D918S-A3N-0300	3.00	20	36	62	6	●
D918S-A3N-0330	3.30	20	36	62	6	●
D918S-A3N-0400	4.00	24	36	66	6	●
D918S-A3N-0420	4.20	24	36	66	6	●
D918S-A3N-0500	5.00	28	36	66	6	●
D918S-A3N-0600	6.00	28	36	66	6	●
D918S-A3N-0680	6.80	34	36	79	8	●
D918S-A3N-0700	7.00	34	36	79	8	●
D918S-A3N-0800	8.00	41	36	79	8	●
D918S-A3N-0850	8.50	47	40	89	10	●
D918S-A3N-0900	9.00	47	40	89	10	●
D918S-A3N-1000	10.00	47	40	89	10	●
D918S-A3N-1030	10.30	55	45	102	12	○

Ordering Code	D(m7)	Lc	L4	L	d(h6)	Stock
D918S-A3N-1050	10.50	55	45	102	12	●
D918S-A3N-1100	11.00	55	45	102	12	●
D918S-A3N-1200	12.00	55	45	102	12	●
D918S-A3N-1250	12.50	60	45	107	14	○
D918S-A3N-1300	13.00	60	45	107	14	●
D918S-A3N-1400	14.00	60	45	107	14	●
D918S-A3N-1450	14.50	65	48	115	16	●
D918S-A3N-1500	15.00	65	48	115	16	○
D918S-A3N-1600	16.00	65	48	115	16	○
D918S-A3N-1700	17.00	73	48	123	18	○
D918S-A3N-1800	18.00	73	48	123	18	○
D918S-A3N-1900	19.00	79	50	131	20	○
D918S-A3N-2000	20.00	79	50	131	20	○

Note: Accept non-standard custom from D3 to D20 tool.

● Stock ○ Available upon Order

Nominal Size Range	D(m7)	d(h6)
≥2-3	+0.002/+0.012	0.000/-0.006
>3-6	+0.004/+0.016	0.000/-0.008
>6-10	+0.006/+0.021	0.000/-0.009
>10-18	+0.007/+0.025	0.000/-0.011
>18-20	+0.008/+0.029	0.000/-0.013

Unit(mm)

Workpiece Material					
P			M	K	
1 2 3 4	5	6 7	1 2 3	1 2	3
Carbon Steels, Alloy Steels (<35HRC)	Alloy Steels, Tool Steels (35-48HRC)	PH and Ferrite/Martensitic Stainless (<48HRC)	Stainless Steel	Grey Cast Iron, Nodular Cast Iron (<32HRC)	High Alloy Cast Iron (35-45HRC)
○	○	○	○	○	○

○ Most Suitable ○ Suitable

Recommended Cutting Data ※ P069

D918S-A3C NEW



High Performance 3D Inner Cooling Twist Drills For Steel

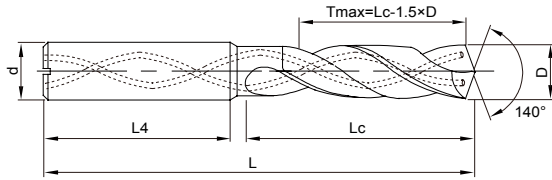

Tmax-Recommended Maximum Depth

Ordering Code	D(m7)	Lc	L4	L	d(h6)	Stock
D918S-A3C-0300	3.00	20	36	62	6	○
D918S-A3C-0330	3.30	20	36	62	6	○
D918S-A3C-0400	4.00	24	36	66	6	○
D918S-A3C-0420	4.20	24	36	66	6	○
D918S-A3C-0500	5.00	28	36	66	6	○
D918S-A3C-0600	6.00	28	36	66	6	○
D918S-A3C-0680	6.80	34	36	79	8	○
D918S-A3C-0700	7.00	34	36	79	8	○
D918S-A3C-0800	8.00	41	36	79	8	○
D918S-A3C-0850	8.50	47	40	89	10	○
D918S-A3C-0900	9.00	47	40	89	10	○
D918S-A3C-1000	10.00	47	40	89	10	○
D918S-A3C-1030	10.30	55	45	102	12	○

Ordering Code	D(m7)	Lc	L4	L	d(h6)	Stock
D918S-A3C-1050	10.50	55	45	102	12	○
D918S-A3C-1100	11.00	55	45	102	12	○
D918S-A3C-1200	12.00	55	45	102	12	○
D918S-A3C-1250	12.50	60	45	107	14	○
D918S-A3C-1300	13.00	60	45	107	14	○
D918S-A3C-1400	14.00	60	45	107	14	○
D918S-A3C-1450	14.50	65	48	115	16	○
D918S-A3C-1500	15.00	65	48	115	16	○
D918S-A3C-1600	16.00	65	48	115	16	○
D918S-A3C-1700	17.00	73	48	123	18	○
D918S-A3C-1800	18.00	73	48	123	18	○
D918S-A3C-1900	19.00	79	50	131	20	○
D918S-A3C-2000	20.00	79	50	131	20	○

Note: Accept non-standard Customization from D3 to D20 tool.

● Stock ○ Available upon Order

Nominal Size Range	D(m7)	d(h6)
≥2-3	+0.002/+0.012	0.000/-0.006
>3-6	+0.004/+0.016	0.000/-0.008
>6-10	+0.006/+0.021	0.000/-0.009
>10-18	+0.007/+0.025	0.000/-0.011
>18-20	+0.008/+0.029	0.000/-0.013

Unit(mm)

Workpiece Material					
P			M	K	
1 2 3 4	5	6 7	1 2 3	1 2	3
Carbon Steels, Alloy Steels (<35HRC)	Alloy Steels, Tool Steels (35-48HRC)	PH and Ferrite/Martensitic Stainless (<48HRC)	Stainless Steel	Grey Cast Iron, Nodular Cast Iron (<32HRC)	High Alloy Cast Iron (35-45HRC)
○	○	○	○	○	○

○ Most Suitable ○ Suitable

Recommended Cutting Data ※ P069

D918S-A5N NEW

High Performance 5D External Cooling Twist Drills For Steel

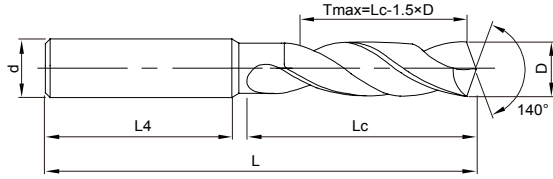

T_{max}-Recommended Maximum Depth

Ordering Code	D(m7)	Lc	L4	L	d(h6)	Stock
D918S-A5N-0300	3.00	28	36	66	6	●
D918S-A5N-0350	3.50	28	36	66	6	●
D918S-A5N-0400	4.00	36	36	74	6	●
D918S-A5N-0420	4.20	36	36	74	6	○
D918S-A5N-0500	5.00	44	36	82	6	●
D918S-A5N-0600	6.00	44	36	82	6	○
D918S-A5N-0680	6.80	53	36	91	8	○
D918S-A5N-0700	7.00	53	36	91	8	○
D918S-A5N-0800	8.00	53	36	91	8	○
D918S-A5N-0850	8.50	61	40	103	10	○
D918S-A5N-0900	9.00	61	40	103	10	○
D918S-A5N-1000	10.00	61	40	103	10	○
D918S-A5N-1030	10.30	71	45	118	12	○

Ordering Code	D(m7)	Lc	L4	L	d(h6)	Stock
D918S-A5N-1050	10.50	71	45	118	12	○
D918S-A5N-1100	11.00	71	45	118	12	○
D918S-A5N-1200	12.00	71	45	118	12	○
D918S-A5N-1250	12.50	77	45	124	14	○
D918S-A5N-1300	13.00	77	45	124	14	○
D918S-A5N-1400	14.00	77	45	124	14	○
D918S-A5N-1450	14.50	83	48	133	16	○
D918S-A5N-1500	15.00	83	48	133	16	○
D918S-A5N-1600	16.00	83	48	133	16	○
D918S-A5N-1700	17.00	93	48	143	18	○
D918S-A5N-1800	18.00	93	48	143	18	○
D918S-A5N-1900	19.00	101	50	153	20	○
D918S-A5N-2000	20.00	101	50	153	20	○

Note: Accept non-standard Customization from D3 to D20 tool.

● Stock ○ Available upon Order

Nominal Size Range	D(m7)	d(h6)
≥2-3	+0.002/+0.012	0.000/-0.006
>3-6	+0.004/+0.016	0.000/-0.008
>6-10	+0.006/+0.021	0.000/-0.009
>10-18	+0.007/+0.025	0.000/-0.011
>18-20	+0.008/+0.029	0.000/-0.013

Unit(mm)

Workpiece Material					
P			M	K	
1 2 3 4	5	6 7	1 2 3	1 2	3
Carbon Steels, Alloy Steels (<35HRC)	Alloy Steels, Tool Steels (35-48HRC)	PH and Ferrite/Martensitic Stainless (<48HRC)	Stainless Steel	Grey Cast Iron, Nodular Cast Iron (<32HRC)	High Alloy Cast Iron (35-45HRC)
○	○	○	○	○	○

○ Most Suitable ○ Suitable

Recommended Cutting Data ※ P069

D918S-A5C NEW



High Performance 5D Inner Cooling Twist Drills For Steel

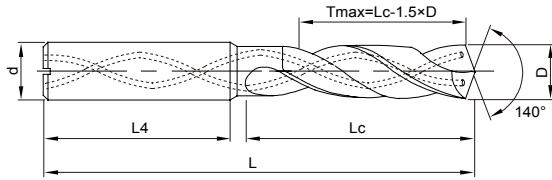

Tmax-Recommended Maximum Depth

Ordering Code	D(m7)	Lc	L4	L	d(h6)	Stock
D918S-A5C-0300	3.00	28	36	66	6	●
D918S-A5C-0330	3.30	28	36	66	6	○
D918S-A5C-0400	4.00	36	36	74	6	●
D918S-A5C-0450	4.50	36	36	74	6	●
D918S-A5C-0500	5.00	44	36	82	6	●
D918S-A5C-0550	5.50	44	36	82	6	●
D918S-A5C-0600	6.00	44	36	82	6	○
D918S-A5C-0700	7.00	53	36	91	8	○
D918S-A5C-0800	8.00	53	36	91	8	○
D918S-A5C-0850	8.50	61	40	103	10	○
D918S-A5C-0900	9.00	61	40	103	10	○
D918S-A5C-1000	10.00	61	40	103	10	○
D918S-A5C-1030	10.30	71	45	118	12	○

Ordering Code	D(m7)	Lc	L4	L	d(h6)	Stock
D918S-A5C-1050	10.50	71	45	118	12	○
D918S-A5C-1100	11.00	71	45	118	12	○
D918S-A5C-1200	12.00	71	45	118	12	○
D918S-A5C-1250	12.50	77	45	124	14	○
D918S-A5C-1300	13.00	77	45	124	14	○
D918S-A5C-1400	14.00	77	45	124	14	○
D918S-A5C-1450	14.50	83	48	133	16	○
D918S-A5C-1500	15.00	83	48	133	16	○
D918S-A5C-1600	16.00	83	48	133	16	○
D918S-A5C-1700	17.00	93	48	143	18	○
D918S-A5C-1800	18.00	93	48	143	18	○
D918S-A5C-1900	19.00	101	50	153	20	○
D918S-A5C-2000	20.00	101	50	153	20	○

Note: Accept non-standard Customization from D3 to D20 tool.

● Stock ○ Available upon Order

Nominal Size Range	D(m7)	d(h6)
≥2-3	+0.002/+0.012	0.000/-0.006
>3-6	+0.004/+0.016	0.000/-0.008
>6-10	+0.006/+0.021	0.000/-0.009
>10-18	+0.007/+0.025	0.000/-0.011
>18-20	+0.008/+0.029	0.000/-0.013

Unit(mm)

Workpiece Material					
P			M	K	
1 2 3 4	5	6 7	1 2 3	1 2	3
Carbon Steels, Alloy Steels (<35HRC)	Alloy Steels, Tool Steels (35-48HRC)	PH and Ferrite/Martensitic Stainless (<48HRC)	Stainless Steel	Grey Cast Iron, Nodular Cast Iron (<32HRC)	High Alloy Cast Iron (35-45HRC)
○	○	○	○	○	○

○ Most Suitable ○ Suitable

Recommended Cutting Data ※ P069

D968S-A3N NEW

High Performance 3D External Cooling Twist Drills for Stainless Steel

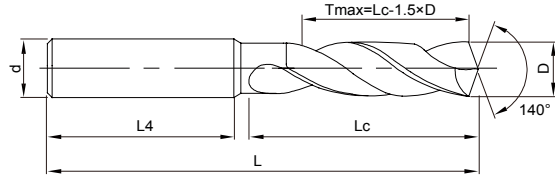

Tmax-Recommended Maximum Depth

Ordering Code	D(m7)	Lc	L4	L	d(h6)	Stock
D968S-A3N-0100	1.00	7	30	45	4	●
D968S-A3N-0200	2.00	13	36	55	4	●
D968S-A3N-0300	3.00	20	36	62	6	●
D968S-A3N-0330	3.30	20	36	62	6	●
D968S-A3N-0400	4.00	24	36	66	6	●
D968S-A3N-0420	4.20	24	36	66	6	●
D968S-A3N-0500	5.00	28	36	66	6	●
D968S-A3N-0600	6.00	28	36	66	6	●
D968S-A3N-0680	6.80	34	36	79	8	●
D968S-A3N-0700	7.00	34	36	79	8	●
D968S-A3N-0800	8.00	41	36	79	8	●
D968S-A3N-0850	8.50	47	40	89	10	●
D968S-A3N-0900	9.00	47	40	89	10	●
D968S-A3N-1000	10.00	47	40	89	10	●

Ordering Code	D(m7)	Lc	L4	L	d(h6)	Stock
D968S-A3N-1030	10.30	55	45	102	12	○
D968S-A3N-1050	10.50	55	45	102	12	○
D968S-A3N-1100	11.00	55	45	102	12	●
D968S-A3N-1200	12.00	55	45	102	12	●
D968S-A3N-1250	12.50	60	45	107	14	●
D968S-A3N-1300	13.00	60	45	107	14	○
D968S-A3N-1400	14.00	60	45	107	14	●
D968S-A3N-1450	14.50	65	48	115	16	○
D968S-A3N-1500	15.00	65	48	115	16	○
D968S-A3N-1600	16.00	65	48	115	16	○
D968S-A3N-1700	17.00	73	48	123	18	○
D968S-A3N-1800	18.00	73	48	123	18	○
D968S-A3N-1900	19.00	79	50	131	20	○
D968S-A3N-2000	20.00	79	50	131	20	○

Note: Accept non-standard Customization from D3 to D20 tool.

● Stock ○ Available upon Order

Nominal Size Range	D(m7)	d(h6)
≥2-3	+0.002/+0.012	0.000/-0.006
>3-6	+0.004/+0.016	0.000/-0.008
>6-10	+0.006/+0.021	0.000/-0.009
>10-18	+0.007/+0.025	0.000/-0.011
>18-20	+0.008/+0.029	0.000/-0.013

Unit(mm)

Workpiece Material			
P	M	S	
1 2 3 4	1 2 3	1 2	3
Carbon Steels, Alloy Steels (<35HRC)	Stainless Steel	Heat Resistant Super Alloys (<45HB)	Titanium Alloys (<400HB)
○	◎	○	○

◎ Most Suitable ○ Suitable

Recommended Cutting Data ※ P071

D968S-A3C NEW



High Performance 3D Inner Cooling Twist Drills for Stainless Steel

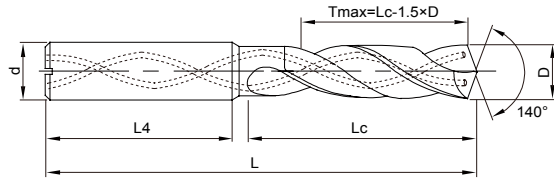

Tmax-Recommended Maximum Depth

Ordering Code	D(m7)	Lc	L4	L	d(h6)	Stock
D968S-A3C-0300	3.00	20	36	62	6	○
D968S-A3C-0330	3.30	20	36	62	6	○
D968S-A3C-0400	4.00	24	36	66	6	○
D968S-A3C-0420	4.20	24	36	66	6	○
D968S-A3C-0500	5.00	28	36	66	6	○
D968S-A3C-0600	6.00	28	36	66	6	○
D968S-A3C-0680	6.80	34	36	79	8	○
D968S-A3C-0700	7.00	34	36	79	8	○
D968S-A3C-0800	8.00	41	36	79	8	○
D968S-A3C-0850	8.50	47	40	89	10	○
D968S-A3C-0900	9.00	47	40	89	10	○
D968S-A3C-1000	10.00	47	40	89	10	○
D968S-A3C-1030	10.30	55	45	102	12	○

Ordering Code	D(m7)	Lc	L4	L	d(h6)	Stock
D968S-A3C-1050	10.50	55	45	102	12	○
D968S-A3C-1100	11.00	55	45	102	12	○
D968S-A3C-1200	12.00	55	45	102	12	○
D968S-A3C-1250	12.50	60	45	107	14	○
D968S-A3C-1300	13.00	60	45	107	14	○
D968S-A3C-1400	14.00	60	45	107	14	○
D968S-A3C-1450	14.50	65	48	115	16	○
D968S-A3C-1500	15.00	65	48	115	16	○
D968S-A3C-1600	16.00	65	48	115	16	○
D968S-A3C-1700	17.00	73	48	123	18	○
D968S-A3C-1800	18.00	73	48	123	18	○
D968S-A3C-1900	19.00	79	50	131	20	○
D968S-A3C-2000	20.00	79	50	131	20	○

Note: Accept non-standard Customization from D2 to D20 tool.

● Stock ○ Available upon Order

Nominal Size Range	D(m7)	d(h6)
≥2-3	+0.002/+0.012	0.000/-0.006
>3-6	+0.004/+0.016	0.000/-0.008
>6-10	+0.006/+0.021	0.000/-0.009
>10-18	+0.007/+0.025	0.000/-0.011
>18-20	+0.008/+0.029	0.000/-0.013

Unit(mm)

Workpiece Material			
P	M	S	
1 2 3 4	1 2 3	1 2	3
Carbon Steels, Alloy Steels (<35HRC)	Stainless Steel	Heat Resistant Super Alloys (<45HB)	Titanium Alloys (<400HB)
○	◎	○	○

◎ Most Suitable ○ Suitable

Recommended Cutting Data ※ P071

D968S-A5N NEW

High Performance 5D External Cooling Twist Drills for Stainless Steel

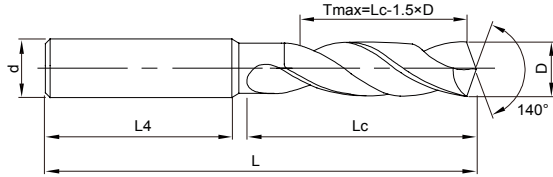

Tmax-Recommended Maximum Depth

Ordering Code	D(m7)	Lc	L4	L	d(h6)	Stock
D968S-A5N-0300	3.00	28	36	66	6	○
D968S-A5N-0330	3.30	28	36	66	6	○
D968S-A5N-0400	4.00	36	36	74	6	○
D968S-A5N-0420	4.20	36	36	74	6	○
D968S-A5N-0500	5.00	44	36	82	6	○
D968S-A5N-0600	6.00	44	36	82	6	○
D968S-A5N-0680	6.80	53	36	91	8	○
D968S-A5N-0700	7.00	53	36	91	8	○
D968S-A5N-0800	8.00	53	36	91	8	○
D968S-A5N-0850	8.50	61	40	103	10	○
D968S-A5N-0900	9.00	61	40	103	10	○
D968S-A5N-1000	10.00	61	40	103	10	○
D968S-A5N-1030	10.30	71	45	118	12	○

Ordering Code	D(m7)	Lc	L4	L	d(h6)	Stock
D968S-A5N-1050	10.50	71	45	118	12	○
D968S-A5N-1100	11.00	71	45	118	12	○
D968S-A5N-1200	12.00	71	45	118	12	○
D968S-A5N-1250	12.50	77	45	124	14	○
D968S-A5N-1300	13.00	77	45	124	14	○
D968S-A5N-1400	14.00	77	45	124	14	○
D968S-A5N-1450	14.50	83	48	133	16	○
D968S-A5N-1500	15.00	83	48	133	16	○
D968S-A5N-1600	16.00	83	48	133	16	○
D968S-A5N-1700	17.00	93	48	143	18	○
D968S-A5N-1800	18.00	93	48	143	18	○
D968S-A5N-1900	19.00	101	50	153	20	○
D968S-A5N-2000	20.00	101	50	153	20	○

Note: Accept non-standard custom from D1 to D20 tool.

● Stock ○ Available upon Order

Nominal Size Range	D(m7)	d(h6)
≥2-3	+0.002/+0.012	0.000/-0.006
>3-6	+0.004/+0.016	0.000/-0.008
>6-10	+0.006/+0.021	0.000/-0.009
>10-18	+0.007/+0.025	0.000/-0.011
>18-20	+0.008/+0.029	0.000/-0.013

Unit(mm)

Workpiece Material			
P	M	S	
1 2 3 4	1 2 3	1 2	3
Carbon Steels, Alloy Steels (<35HRC)	Stainless Steel	Heat Resistant Super Alloys (<45HB)	Titanium Alloys (<400HB)
○	◎	○	○

◎ Most Suitable ○ Suitable

Recommended Cutting Data ※ P071

D968S-A5C NEW

High Performance 5D Inner Cooling Twist Drills for Stainless Steel

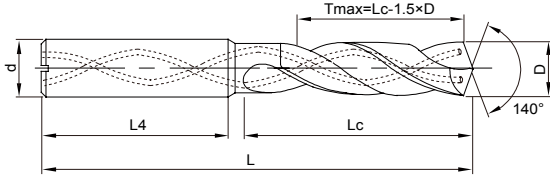

Tmax-Recommended Maximum Depth

Ordering Code	D(m7)	Lc	L4	L	d(h6)	Stock
D968S-A5C-0300	3.00	28	36	66	6	○
D968S-A5C-0330	3.30	28	36	66	6	○
D968S-A5C-0400	4.00	36	36	74	6	○
D968S-A5C-0420	4.20	36	36	74	6	○
D968S-A5C-0500	5.00	44	36	82	6	○
D968S-A5C-0600	6.00	44	36	82	6	○
D968S-A5C-0680	6.80	53	36	91	8	○
D968S-A5C-0700	7.00	53	36	91	8	○
D968S-A5C-0800	8.00	53	36	91	8	○
D968S-A5C-0850	8.50	61	40	103	10	○
D968S-A5C-0900	9.00	61	40	103	10	○
D968S-A5C-1000	10.00	61	40	103	10	○
D968S-A5C-1030	10.30	71	45	118	12	○

Ordering Code	D(m7)	Lc	L4	L	d(h6)	Stock
D968S-A5C-1050	10.50	71	45	118	12	○
D968S-A5C-1100	11.00	71	45	118	12	○
D968S-A5C-1200	12.00	71	45	118	12	○
D968S-A5C-1250	12.50	77	45	124	14	○
D968S-A5C-1300	13.00	77	45	124	14	○
D968S-A5C-1400	14.00	77	45	124	14	○
D968S-A5C-1450	14.50	83	48	133	16	○
D968S-A5C-1500	15.00	83	48	133	16	○
D968S-A5C-1600	16.00	83	48	133	16	○
D968S-A5C-1700	17.00	93	48	143	18	○
D968S-A5C-1800	18.00	93	48	143	18	○
D968S-A5C-1900	19.00	101	50	153	20	○
D968S-A5C-2000	20.00	101	50	153	20	○

Note: Accept non-standard Customization from D2 to D20 tool.

● Stock ○ Available upon Order

Nominal Size Range	D(m7)	d(h6)
≥2-3	+0.002/+0.012	0.000/-0.006
>3-6	+0.004/+0.016	0.000/-0.008
>6-10	+0.006/+0.021	0.000/-0.009
>10-18	+0.007/+0.025	0.000/-0.011
>18-20	+0.008/+0.029	0.000/-0.013

Unit(mm)

Workpiece Material			
P	M	S	
1 2 3 4	1 2 3	1 2	3
Carbon Steels, Alloy Steels (<35HRC)	Stainless Steel	Heat Resistant Super Alloys (<45HB)	Titanium Alloys (<400HB)
○	◎	○	○

◎ Most Suitable ○ Suitable

Recommended Cutting Data ※ P071

D938-A3N

3D External Cooling Twist Drills for Steel

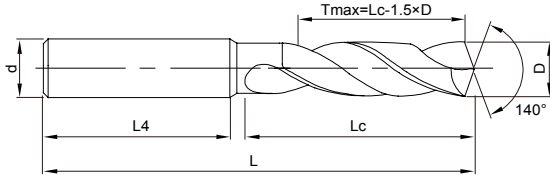

Tmax-Recommended Maximum Depth

Ordering Code	D(m7)	Lc	L4	L	d(h6)	Stock
D938-A3N-0300	3.00	20	36	62	6	●
D938-A3N-0310	3.10	20	36	62	6	●
D938-A3N-0320	3.20	20	36	62	6	●
D938-A3N-0330	3.30	20	36	62	6	●
D938-A3N-0340	3.40	20	36	62	6	●
D938-A3N-0350	3.50	20	36	62	6	●
D938-A3N-0360	3.60	20	36	62	6	●
D938-A3N-0370	3.70	20	36	62	6	●
D938-A3N-0380	3.80	24	36	66	6	●
D938-A3N-0390	3.90	24	36	66	6	●
D938-A3N-0400	4.00	24	36	66	6	●
D938-A3N-0410	4.10	24	36	66	6	●
D938-A3N-0420	4.20	24	36	66	6	●
D938-A3N-0430	4.30	24	36	66	6	●
D938-A3N-0440	4.40	24	36	66	6	●

Ordering Code	D(m7)	Lc	L4	L	d(h6)	Stock
D938-A3N-0450	4.50	24	36	66	6	●
D938-A3N-0460	4.60	24	36	66	6	●
D938-A3N-0470	4.70	24	36	66	6	●
D938-A3N-0480	4.80	28	36	66	6	●
D938-A3N-0490	4.90	28	36	66	6	●
D938-A3N-0500	5.00	28	36	66	6	●
D938-A3N-0510	5.10	28	36	66	6	●
D938-A3N-0520	5.20	28	36	66	6	●
D938-A3N-0530	5.30	28	36	66	6	●
D938-A3N-0540	5.40	28	36	66	6	●
D938-A3N-0550	5.50	28	36	66	6	●
D938-A3N-0560	5.60	28	36	66	6	●
D938-A3N-0570	5.70	28	36	66	6	●
D938-A3N-0580	5.80	28	36	66	6	●
D938-A3N-0590	5.90	28	36	66	6	●

Note: Accept non-standard custom from D1 to D20 tool.

● Stock ○ Available upon Order

Nominal Size Range	D(m7)	d(h6)
≥2-3	+0.002/+0.012	0.000/-0.006
>3-6	+0.004/+0.016	0.000/-0.008
>6-10	+0.006/+0.021	0.000/-0.009
>10-18	+0.007/+0.025	0.000/-0.011
>18-20	+0.008/+0.029	0.000/-0.013

Unit(mm)

Workpiece Material				
P			K	
1 2 3 4	5	6 7	1 2	3
Carbon Steels, Alloy Steels (<35HRC)	Alloy Steels, Tool Steels (35-48HRC)	PH and Ferrite/Martensitic Stainless (<48HRC)	Grey Cast Iron, Nodular Cast Iron (<32HRC)	High Alloy Cast Iron (35-45HRC)
○	○	○	○	○

○ Most Suitable ○ Suitable

Recommended Cutting Data ※ P073

D938-A3N

3D External Cooling Twist Drills for Steel

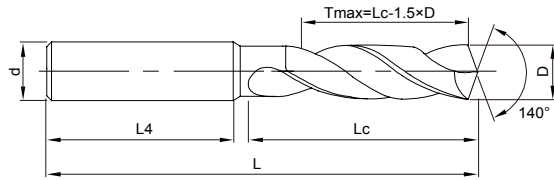

Tmax-Recommended Maximum Depth

» Continue

Ordering Code	D(m7)	Lc	L4	L	d(h6)	Stock
D938-A3N-0600	6.00	28	36	66	6	●
D938-A3N-0610	6.10	34	36	79	8	●
D938-A3N-0620	6.20	34	36	79	8	●
D938-A3N-0630	6.30	34	36	79	8	●
D938-A3N-0640	6.40	34	36	79	8	●
D938-A3N-0650	6.50	34	36	79	8	●
D938-A3N-0660	6.60	34	36	79	8	●
D938-A3N-0670	6.70	34	36	79	8	●
D938-A3N-0680	6.80	34	36	79	8	●
D938-A3N-0690	6.90	34	36	79	8	●
D938-A3N-0700	7.00	34	36	79	8	●
D938-A3N-0710	7.10	41	36	79	8	●
D938-A3N-0720	7.20	41	36	79	8	●
D938-A3N-0730	7.30	41	36	79	8	●
D938-A3N-0740	7.40	41	36	79	8	●

Ordering Code	D(m7)	Lc	L4	L	d(h6)	Stock
D938-A3N-0750	7.50	41	36	79	8	●
D938-A3N-0760	7.60	41	36	79	8	●
D938-A3N-0770	7.70	41	36	79	8	●
D938-A3N-0780	7.80	41	36	79	8	●
D938-A3N-0790	7.90	41	36	79	8	●
D938-A3N-0800	8.00	41	36	79	8	●
D938-A3N-0810	8.10	47	40	89	10	●
D938-A3N-0820	8.20	47	40	89	10	●
D938-A3N-0830	8.30	47	40	89	10	●
D938-A3N-0840	8.40	47	40	89	10	●
D938-A3N-0850	8.50	47	40	89	10	●
D938-A3N-0860	8.60	47	40	89	10	●
D938-A3N-0870	8.70	47	40	89	10	●
D938-A3N-0880	8.80	47	40	89	10	●
D938-A3N-0890	8.90	47	40	89	10	●

Note: Accept non-standard custom from D1 to D20 tool.

● Stock ○ Available upon Order

Nominal Size Range	D(m7)	d(h6)
≥2-3	+0.002/+0.012	0.000/-0.006
>3-6	+0.004/+0.016	0.000/-0.008
>6-10	+0.006/+0.021	0.000/-0.009
>10-18	+0.007/+0.025	0.000/-0.011
>18-20	+0.008/+0.029	0.000/-0.013

Unit(mm)

Workpiece Material				
P			K	
1 2 3 4	5	6 7	1 2	3
Carbon Steels, Alloy Steels (<35HRC)	Alloy Steels, Tool Steels (35-48HRC)	PH and Ferrite/Martensitic Stainless (<48HRC)	Grey Cast Iron, Nodular Cast Iron (<32HRC)	High Alloy Cast Iron (35-45HRC)
◎	◎	○	○	○

◎ Most Suitable ○ Suitable

Recommended Cutting Data ※ P073

D938-A3N

3D External Cooling Twist Drills for Steel

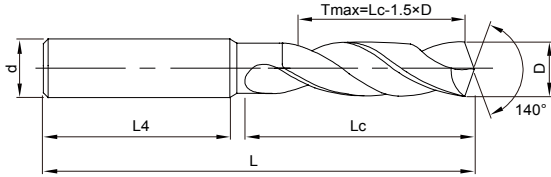

Tmax-Recommended Maximum Depth

» Continue

Ordering Code	D(m7)	Lc	L4	L	d(h6)	Stock
D938-A3N-0900	9.00	47	40	89	10	●
D938-A3N-0910	9.10	47	40	89	10	●
D938-A3N-0920	9.20	47	40	89	10	●
D938-A3N-0925	9.25	47	40	89	10	○
D938-A3N-0930	9.30	47	40	89	10	●
D938-A3N-0940	9.40	47	40	89	10	●
D938-A3N-0950	9.50	47	40	89	10	●
D938-A3N-0960	9.60	47	40	89	10	○
D938-A3N-0970	9.70	47	40	89	10	●
D938-A3N-0980	9.80	47	40	89	10	●
D938-A3N-0990	9.90	47	40	89	10	●
D938-A3N-1000	10.00	47	40	89	10	●
D938-A3N-1010	10.10	55	45	102	12	●
D938-A3N-1020	10.20	55	45	102	12	●
D938-A3N-1030	10.30	55	45	102	12	●

Ordering Code	D(m7)	Lc	L4	L	d(h6)	Stock
D938-A3N-1040	10.40	55	45	102	12	●
D938-A3N-1050	10.50	55	45	102	12	●
D938-A3N-1060	10.60	55	45	102	12	●
D938-A3N-1070	10.70	55	45	102	12	●
D938-A3N-1080	10.80	55	45	102	12	●
D938-A3N-1090	10.90	55	45	102	12	●
D938-A3N-1100	11.00	55	45	102	12	●
D938-A3N-1110	11.10	55	45	102	12	●
D938-A3N-1120	11.20	55	45	102	12	●
D938-A3N-1130	11.30	55	45	102	12	●
D938-A3N-1140	11.40	55	45	102	12	●
D938-A3N-1150	11.50	55	45	102	12	●
D938-A3N-1160	11.60	55	45	102	12	○
D938-A3N-1170	11.70	55	45	102	12	○
D938-A3N-1180	11.80	55	45	102	12	●

Note: Accept non-standard custom from D1 to D20 tool.

● Stock ○ Available upon Order

Nominal Size Range	D(m7)	d(h6)
≥2-3	+0.002/+0.012	0.000/-0.006
>3-6	+0.004/+0.016	0.000/-0.008
>6-10	+0.006/+0.021	0.000/-0.009
>10-18	+0.007/+0.025	0.000/-0.011
>18-20	+0.008/+0.029	0.000/-0.013

Unit(mm)

Workpiece Material				
P			K	
1 2 3 4	5	6 7	1 2	3
Carbon Steels, Alloy Steels (<35HRC)	Alloy Steels, Tool Steels (35-48HRC)	PH and Ferrite/Martensitic Stainless (<48HRC)	Grey Cast Iron, Nodular Cast Iron (<32HRC)	High Alloy Cast Iron (35-45HRC)
◎	◎	○	○	○

◎ Most Suitable ○ Suitable

Recommended Cutting Data ※ P073

D938-A3N

3D External Cooling Twist Drills for Steel

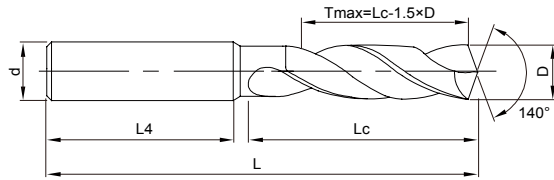

Tmax-Recommended Maximum Depth

» Continue

Ordering Code	D(m7)	Lc	L4	L	d(h6)	Stock
D938-A3N-1190	11.90	55	45	102	12	○
D938-A3N-1200	12.00	55	45	102	12	●
D938-A3N-1250	12.50	60	45	107	14	●
D938-A3N-1280	12.80	60	45	107	14	●
D938-A3N-1300	13.00	60	45	107	14	●
D938-A3N-1350	13.50	60	45	107	14	●
D938-A3N-1380	13.80	60	45	107	14	●
D938-A3N-1400	14.00	60	45	107	14	●
D938-A3N-1450	14.50	65	48	115	16	●
D938-A3N-1480	14.80	65	48	115	16	○
D938-A3N-1500	15.00	65	48	115	16	●
D938-A3N-1550	15.50	65	48	115	16	●
D938-A3N-1580	15.80	65	48	115	16	●

Ordering Code	D(m7)	Lc	L4	L	d(h6)	Stock
D938-A3N-1600	16.00	65	48	115	16	●
D938-A3N-1650	16.50	73	48	123	18	●
D938-A3N-1680	16.80	73	48	123	18	●
D938-A3N-1700	17.00	73	48	123	18	●
D938-A3N-1750	17.50	73	48	123	18	●
D938-A3N-1780	17.80	73	48	123	18	●
D938-A3N-1800	18.00	73	48	123	18	●
D938-A3N-1850	18.50	79	50	131	20	●
D938-A3N-1880	18.80	79	50	131	20	○
D938-A3N-1900	19.00	79	50	131	20	○
D938-A3N-1950	19.50	79	50	131	20	●
D938-A3N-1980	19.80	79	50	131	20	●
D938-A3N-2000	20.00	79	50	131	20	●

Note: Accept non-standard custom from D1 to D20 tool.

● Stock ○ Available upon Order

Nominal Size Range	D(m7)	d(h6)
≥2-3	+0.002/+0.012	0.000/-0.006
>3-6	+0.004/+0.016	0.000/-0.008
>6-10	+0.006/+0.021	0.000/-0.009
>10-18	+0.007/+0.025	0.000/-0.011
>18-20	+0.008/+0.029	0.000/-0.013

Unit(mm)

Workpiece Material				
P			K	
1 2 3 4	5	6 7	1 2	3
Carbon Steels, Alloy Steels (<35HRC)	Alloy Steels, Tool Steels (35-48HRC)	PH and Ferrite/Martensitic Stainless (<48HRC)	Grey Cast Iron, Nodular Cast Iron (<32HRC)	High Alloy Cast Iron (35-45HRC)
◎	◎	○	○	○

◎ Most Suitable ○ Suitable

Recommended Cutting Data ※ P073

D938-A3C

3D Inner Cooling Twist Drills for Steel

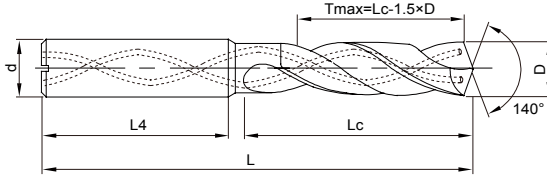

Tmax-Recommended Maximum Depth

Ordering Code	D(m7)	Lc	L4	L	d(h6)	Stock
D938-A3C-0300	3.00	20	36	62	6	●
D938-A3C-0310	3.10	20	36	62	6	●
D938-A3C-0320	3.20	20	36	62	6	●
D938-A3C-0330	3.30	20	36	62	6	●
D938-A3C-0340	3.40	20	36	62	6	●
D938-A3C-0350	3.50	20	36	62	6	●
D938-A3C-0360	3.60	20	36	62	6	●
D938-A3C-0370	3.70	20	36	62	6	●
D938-A3C-0380	3.80	24	36	66	6	●
D938-A3C-0390	3.90	24	36	66	6	●
D938-A3C-0400	4.00	24	36	66	6	●
D938-A3C-0410	4.10	24	36	66	6	●
D938-A3C-0420	4.20	24	36	66	6	●
D938-A3C-0430	4.30	24	36	66	6	●
D938-A3C-0440	4.40	24	36	66	6	●

Ordering Code	D(m7)	Lc	L4	L	d(h6)	Stock
D938-A3C-0450	4.50	24	36	66	6	●
D938-A3C-0460	4.60	24	36	66	6	●
D938-A3C-0470	4.70	24	36	66	6	●
D938-A3C-0480	4.80	28	36	66	6	●
D938-A3C-0490	4.90	28	36	66	6	●
D938-A3C-0500	5.00	28	36	66	6	●
D938-A3C-0510	5.10	28	36	66	6	●
D938-A3C-0520	5.20	28	36	66	6	●
D938-A3C-0530	5.30	28	36	66	6	●
D938-A3C-0540	5.40	28	36	66	6	○
D938-A3C-0550	5.50	28	36	66	6	●
D938-A3C-0560	5.60	28	36	66	6	●
D938-A3C-0570	5.70	28	36	66	6	○
D938-A3C-0580	5.80	28	36	66	6	●
D938-A3C-0590	5.90	28	36	66	6	●

Note: Accept non-standard custom from D2to D20 tool.

● Stock ○ Available upon Order

Nominal Size Range	D(m7)	d(h6)
≥2-3	+0.002/+0.012	0.000/-0.006
>3-6	+0.004/+0.016	0.000/-0.008
>6-10	+0.006/+0.021	0.000/-0.009
>10-18	+0.007/+0.025	0.000/-0.011
>18-20	+0.008/+0.029	0.000/-0.013

Unit(mm)

Workpiece Material				
P			K	
1 2 3 4	5	6 7	1 2	3
Carbon Steels, Alloy Steels (<35HRC)	Alloy Steels, Tool Steels (35-48HRC)	PH and Ferrite/Martensitic Stainless (<48HRC)	Grey Cast Iron, Nodular Cast Iron (<32HRC)	High Alloy Cast Iron (35-45HRC)
◎	◎	○	○	○

◎ Most Suitable ○ Suitable

Recommended Cutting Data ※ P073

D938-A3C

3D Inner Cooling Twist Drills for Steel

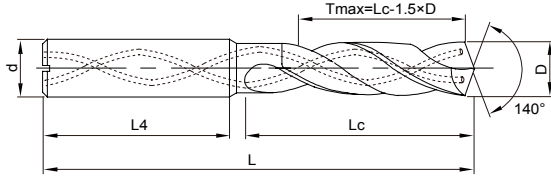

Tmax-Recommended Maximum Depth



» Continue

Ordering Code	D(m7)	Lc	L4	L	d(h6)	Stock
D938-A3C-0600	6.00	28	36	66	6	●
D938-A3C-0610	6.10	34	36	79	8	●
D938-A3C-0620	6.20	34	36	79	8	●
D938-A3C-0630	6.30	34	36	79	8	○
D938-A3C-0640	6.40	34	36	79	8	●
D938-A3C-0650	6.50	34	36	79	8	●
D938-A3C-0660	6.60	34	36	79	8	●
D938-A3C-0670	6.70	34	36	79	8	●
D938-A3C-0680	6.80	34	36	79	8	●
D938-A3C-0690	6.90	34	36	79	8	●
D938-A3C-0700	7.00	34	36	79	8	●
D938-A3C-0710	7.10	41	36	79	8	○
D938-A3C-0720	7.20	41	36	79	8	●
D938-A3C-0730	7.30	41	36	79	8	●
D938-A3C-0740	7.40	41	36	79	8	●

Ordering Code	D(m7)	Lc	L4	L	d(h6)	Stock
D938-A3C-0750	7.50	41	36	79	8	●
D938-A3C-0760	7.60	41	36	79	8	○
D938-A3C-0770	7.70	41	36	79	8	○
D938-A3C-0780	7.80	41	36	79	8	○
D938-A3C-0790	7.90	41	36	79	8	○
D938-A3C-0800	8.00	41	36	79	8	●
D938-A3C-0810	8.10	47	40	89	10	●
D938-A3C-0820	8.20	47	40	89	10	●
D938-A3C-0830	8.30	47	40	89	10	●
D938-A3C-0840	8.40	47	40	89	10	●
D938-A3C-0850	8.50	47	40	89	10	●
D938-A3C-0860	8.60	47	40	89	10	●
D938-A3C-0870	8.70	47	40	89	10	●
D938-A3C-0880	8.80	47	40	89	10	●
D938-A3C-0890	8.90	47	40	89	10	●

Note: Accept non-standard custom from D2to D20 tool.

● Stock ○ Available upon Order

Nominal Size Range	D(m7)	d(h6)
≥2-3	+0.002/+0.012	0.000/-0.006
>3-6	+0.004/+0.016	0.000/-0.008
>6-10	+0.006/+0.021	0.000/-0.009
>10-18	+0.007/+0.025	0.000/-0.011
>18-20	+0.008/+0.029	0.000/-0.013

Unit(mm)

Workpiece Material				
P			K	
1 2 3 4	5	6 7	1 2	3
Carbon Steels, Alloy Steels (<35HRC)	Alloy Steels, Tool Steels (35-48HRC)	PH and Ferrite/Martensitic Stainless (<48HRC)	Grey Cast Iron, Nodular Cast Iron (<32HRC)	High Alloy Cast Iron (35-45HRC)
○	○	○	○	○

○ Most Suitable ○ Suitable

Recommended Cutting Data ※ P073

D938-A3C

3D Inner Cooling Twist Drills for Steel

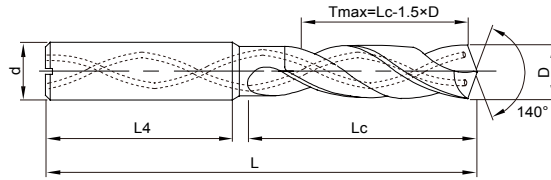

Tmax-Recommended Maximum Depth

» Continue

Ordering Code	D(m7)	Lc	L4	L	d(h6)	Stock
D938-A3C-0900	9.00	47	40	89	10	●
D938-A3C-0910	9.10	47	40	89	10	○
D938-A3C-0920	9.20	47	40	89	10	○
D938-A3C-0930	9.30	47	40	89	10	●
D938-A3C-0940	9.40	47	40	89	10	●
D938-A3C-0950	9.50	47	40	89	10	●
D938-A3C-0960	9.60	47	40	89	10	○
D938-A3C-0970	9.70	47	40	89	10	●
D938-A3C-0980	9.80	47	40	89	10	●
D938-A3C-0990	9.90	47	40	89	10	●
D938-A3C-1000	10.00	47	40	89	10	●
D938-A3C-1010	10.10	55	45	102	12	●
D938-A3C-1020	10.20	55	45	102	12	●
D938-A3C-1030	10.30	55	45	102	12	●
D938-A3C-1040	10.40	55	45	102	12	●

Ordering Code	D(m7)	Lc	L4	L	d(h6)	Stock
D938-A3C-1050	10.50	55	45	102	12	●
D938-A3C-1060	10.60	55	45	102	12	●
D938-A3C-1070	10.70	55	45	102	12	●
D938-A3C-1080	10.80	55	45	102	12	●
D938-A3C-1090	10.90	55	45	102	12	●
D938-A3C-1100	11.00	55	45	102	12	●
D938-A3C-1110	11.10	55	45	102	12	●
D938-A3C-1120	11.20	55	45	102	12	●
D938-A3C-1130	11.30	55	45	102	12	●
D938-A3C-1140	11.40	55	45	102	12	●
D938-A3C-1150	11.50	55	45	102	12	○
D938-A3C-1160	11.60	55	45	102	12	●
D938-A3C-1170	11.70	55	45	102	12	●
D938-A3C-1180	11.80	55	45	102	12	●
D938-A3C-1190	11.90	55	45	102	12	●

Note: Accept non-standard custom from D2to D20 tool.

● Stock ○ Available upon Order

Nominal Size Range	D(m7)	d(h6)
≥2-3	+0.002/+0.012	0.000/-0.006
>3-6	+0.004/+0.016	0.000/-0.008
>6-10	+0.006/+0.021	0.000/-0.009
>10-18	+0.007/+0.025	0.000/-0.011
>18-20	+0.008/+0.029	0.000/-0.013

Unit(mm)

Workpiece Material				
P			K	
1 2 3 4	5	6 7	1 2	3
Carbon Steels, Alloy Steels (<35HRC)	Alloy Steels, Tool Steels (35-48HRC)	PH and Ferrite/Martensitic Stainless (<48HRC)	Grey Cast Iron, Nodular Cast Iron (<32HRC)	High Alloy Cast Iron (35-45HRC)
○	○	○	○	○

○ Most Suitable ○ Suitable

Recommended Cutting Data ※ P073

D938-A3C

3D Inner Cooling Twist Drills for Steel

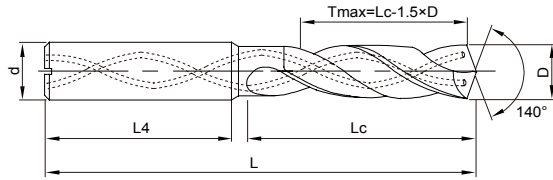

Tmax-Recommended Maximum Depth

» Continue

Ordering Code	D(m7)	Lc	L4	L	d(h6)	Stock
D938-A3C-1200	12.00	55	45	102	12	●
D938-A3C-1250	12.50	60	45	107	14	●
D938-A3C-1280	12.80	60	45	107	14	●
D938-A3C-1300	13.00	60	45	107	14	●
D938-A3C-1350	13.50	60	45	107	14	●
D938-A3C-1380	13.80	60	45	107	14	○
D938-A3C-1400	14.00	60	45	107	14	●
D938-A3C-1450	14.50	65	48	115	16	●
D938-A3C-1480	14.80	65	48	115	16	●
D938-A3C-1500	15.00	65	48	115	16	●
D938-A3C-1550	15.50	65	48	115	16	○
D938-A3C-1580	15.80	65	48	115	16	○
D938-A3C-1600	16.00	65	48	115	16	●

Ordering Code	D(m7)	Lc	L4	L	d(h6)	Stock
D938-A3C-1650	16.50	73	48	123	18	●
D938-A3C-1680	16.80	73	48	123	18	○
D938-A3C-1700	17.00	73	48	123	18	●
D938-A3C-1750	17.50	73	48	123	18	●
D938-A3C-1780	17.80	73	48	123	18	○
D938-A3C-1800	18.00	73	48	123	18	●
D938-A3C-1850	18.50	79	50	131	20	●
D938-A3C-1880	18.80	79	50	131	20	○
D938-A3C-1900	19.00	79	50	131	20	○
D938-A3C-1950	19.50	79	50	131	20	●
D938-A3C-1980	19.80	79	50	131	20	○
D938-A3C-2000	20.00	79	50	131	20	○

Note: Accept non-standard custom from D2to D20 tool.

● Stock ○ Available upon Order

Nominal Size Range	D(m7)	d(h6)
≥2-3	+0.002/+0.012	0.000/-0.006
>3-6	+0.004/+0.016	0.000/-0.008
>6-10	+0.006/+0.021	0.000/-0.009
>10-18	+0.007/+0.025	0.000/-0.011
>18-20	+0.008/+0.029	0.000/-0.013

Unit(mm)

Workpiece Material				
P			K	
1 2 3 4	5	6 7	1 2	3
Carbon Steels, Alloy Steels (<35HRC)	Alloy Steels, Tool Steels (35-48HRC)	PH and Ferrite/Martensitic Stainless (<48HRC)	Grey Cast Iron, Nodular Cast Iron (<32HRC)	High Alloy Cast Iron (35-45HRC)
◎	◎	○	○	○

◎ Most Suitable ○ Suitable

Recommended Cutting Data ※ P073

D938-A5N

5D External Cooling Twist Drills for Steel

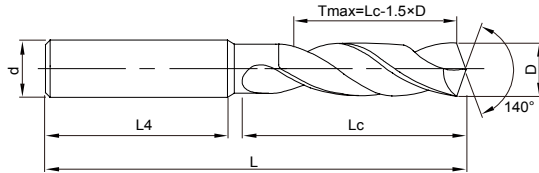

Tmax-Recommended Maximum Depth

Ordering Code	D(m7)	Lc	L4	L	d(h6)	Stock
D938-A5N-0300	3.00	28	36	66	6	●
D938-A5N-0310	3.10	28	36	66	6	○
D938-A5N-0320	3.20	28	36	66	6	●
D938-A5N-0330	3.30	28	36	66	6	●
D938-A5N-0340	3.40	28	36	66	6	○
D938-A5N-0350	3.50	28	36	66	6	●
D938-A5N-0360	3.60	28	36	66	6	●
D938-A5N-0370	3.70	28	36	66	6	○
D938-A5N-0380	3.80	36	36	74	6	●
D938-A5N-0390	3.90	36	36	74	6	○
D938-A5N-0400	4.00	36	36	74	6	●
D938-A5N-0410	4.10	36	36	74	6	○
D938-A5N-0420	4.20	36	36	74	6	●
D938-A5N-0430	4.30	36	36	74	6	●
D938-A5N-0440	4.40	36	36	74	6	●

Ordering Code	D(m7)	Lc	L4	L	d(h6)	Stock
D938-A5N-0450	4.5	36	36	74	6	●
D938-A5N-0460	4.6	36	36	74	6	○
D938-A5N-0465	4.65	36	36	74	6	○
D938-A5N-0470	4.7	36	36	74	6	○
D938-A5N-0480	4.8	44	36	82	6	●
D938-A5N-0490	4.9	44	36	82	6	○
D938-A5N-0500	5.0	44	36	82	6	●
D938-A5N-0510	5.1	44	36	82	6	●
D938-A5N-0520	5.2	44	36	82	6	●
D938-A5N-0530	5.3	44	36	82	6	○
D938-A5N-0540	5.4	44	36	82	6	○
D938-A5N-0550	5.5	44	36	82	6	●
D938-A5N-0555	5.55	44	36	82	6	○
D938-A5N-0560	5.6	44	36	82	6	●
D938-A5N-0570	5.7	44	36	82	6	○

Note: Accept non-standard custom from D1 to D20 tool.

● Stock ○ Available upon Order

Nominal Size Range	D(m7)	d(h6)
≥2—3	+0.002/+0.012	0.000/-0.006
>3—6	+0.004/+0.016	0.000/-0.008
>6—10	+0.006/+0.021	0.000/-0.009
>10—18	+0.007/+0.025	0.000/-0.011
>18—20	+0.008/+0.029	0.000/-0.013

Unit(mm)

Workpiece Material				
P			K	
1 2 3 4	5	6 7	1 2	3
Carbon Steels, Alloy Steels (<35HRC)	Alloy Steels, Tool Steels (35-48HRC)	PH and Ferrite/Martensitic Stainless (<48HRC)	Grey Cast Iron, Nodular Cast Iron (<32HRC)	High Alloy Cast Iron (35-45HRC)
○	○	○	○	○

○ Most Suitable ○ Suitable

Recommended Cutting Data ※ P073

D938-A5N

5D External Cooling Twist Drills for Steel

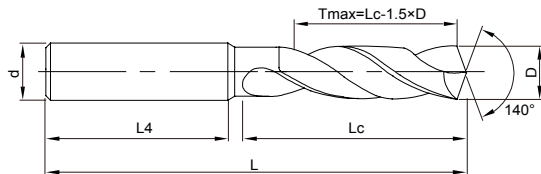

Tmax-Recommended Maximum Depth

» Continue

Ordering Code	D(m7)	Lc	L4	L	d(h6)	Stock
D938-A5N-0580	5.8	44	36	82	6	●
D938-A5N-0590	5.9	44	36	82	6	●
D938-A5N-0600	6.0	44	36	82	6	●
D938-A5N-0610	6.1	53	36	91	8	○
D938-A5N-0620	6.2	53	36	91	8	●
D938-A5N-0630	6.3	53	36	91	8	●
D938-A5N-0640	6.4	53	36	91	8	●
D938-A5N-0650	6.5	53	36	91	8	●
D938-A5N-0660	6.6	53	36	91	8	●
D938-A5N-0670	6.7	53	36	91	8	●
D938-A5N-0680	6.8	53	36	91	8	●
D938-A5N-0690	6.9	53	36	91	8	●
D938-A5N-0700	7.0	53	36	91	8	●
D938-A5N-0710	7.1	53	36	91	8	●
D938-A5N-0720	7.2	53	36	91	8	○

Ordering Code	D(m7)	Lc	L4	L	d(h6)	Stock
D938-A5N-0730	7.3	53	36	91	8	○
D938-A5N-0740	7.4	53	36	91	8	●
D938-A5N-0750	7.5	53	36	91	8	●
D938-A5N-0760	7.6	53	36	91	8	○
D938-A5N-0770	7.7	53	36	91	8	●
D938-A5N-0780	7.8	53	36	91	8	●
D938-A5N-0790	7.9	53	36	91	8	○
D938-A5N-0800	8.0	53	36	91	8	●
D938-A5N-0810	8.1	61	40	103	10	○
D938-A5N-0820	8.2	61	40	103	10	●
D938-A5N-0830	8.3	61	40	103	10	○
D938-A5N-0840	8.4	61	40	103	10	●
D938-A5N-0850	8.5	61	40	103	10	●
D938-A5N-0860	8.6	61	40	103	10	●
D938-A5N-0870	8.7	61	40	103	10	●

Note: Accept non-standard custom from D1 to D20 stock.

● Stock ○ Available upon Order

Nominal Size Range	D(m7)	d(h6)
≥2-3	+0.002/+0.012	0.000/-0.006
>3-6	+0.004/+0.016	0.000/-0.008
>6-10	+0.006/+0.021	0.000/-0.009
>10-18	+0.007/+0.025	0.000/-0.011
>18-20	+0.008/+0.029	0.000/-0.013

Unit(mm)

Workpiece Material				
P			K	
1 2 3 4	5	6 7	1 2	3
Carbon Steels, Alloy Steels (<35HRC)	Alloy Steels, Tool Steels (35-48HRC)	PH and Ferrite/Martensitic Stainless (<48HRC)	Grey Cast Iron, Nodular Cast Iron (<32HRC)	High Alloy Cast Iron (35-45HRC)
○	○	○	○	○

○ Most Suitable ○ Suitable

Recommended Cutting Data ※ P073

D938-A5N

5D External Cooling Twist Drills for Steel

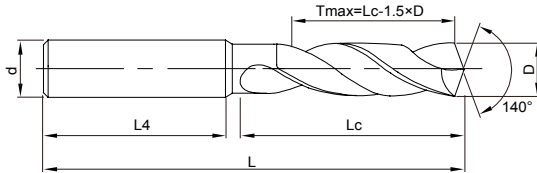

Tmax-Recommended Maximum Depth

» Continue

Ordering Code	D(m7)	Lc	L4	L	d(h6)	Stock
D938-A5N-0880	8.8	61	40	103	10	●
D938-A5N-0890	8.9	61	40	103	10	○
D938-A5N-0900	9.0	61	40	103	10	●
D938-A5N-0910	9.1	61	40	103	10	●
D938-A5N-0920	9.2	61	40	103	10	○
D938-A5N-0930	9.3	61	40	103	10	●
D938-A5N-0940	9.4	61	40	103	10	○
D938-A5N-0950	9.5	61	40	103	10	●
D938-A5N-0960	9.6	61	40	103	10	●
D938-A5N-0970	9.7	61	40	103	10	○
D938-A5N-0980	9.8	61	40	103	10	●
D938-A5N-0990	9.9	61	40	103	10	●
D938-A5N-1000	10.0	61	40	103	10	●
D938-A5N-1010	10.1	71	45	118	12	○
D938-A5N-1020	10.2	71	45	118	12	●

Ordering Code	D(m7)	Lc	L4	L	d(h6)	Stock
D938-A5N-1025	10.25	71	45	118	12	○
D938-A5N-1030	10.3	71	45	118	12	●
D938-A5N-1040	10.4	71	45	118	12	○
D938-A5N-1050	10.5	71	45	118	12	●
D938-A5N-1060	10.6	71	45	118	12	●
D938-A5N-1070	10.7	71	45	118	12	●
D938-A5N-1080	10.8	71	45	118	12	○
D938-A5N-1090	10.9	71	45	118	12	○
D938-A5N-1100	11.0	71	45	118	12	●
D938-A5N-1110	11.1	71	45	118	12	●
D938-A5N-1120	11.2	71	45	118	12	●
D938-A5N-1130	11.3	71	45	118	12	○
D938-A5N-1140	11.4	71	45	118	12	●
D938-A5N-1150	11.5	71	45	118	12	○
D938-A5N-1160	11.6	71	45	118	12	●

Note: Accept non-standard custom from D1 to D20 tool.

● Stock ○ Available upon Order

Nominal Size Range	D(m7)	d(h6)
≥2-3	+0.002/+0.012	0.000/-0.006
>3-6	+0.004/+0.016	0.000/-0.008
>6-10	+0.006/+0.021	0.000/-0.009
>10-18	+0.007/+0.025	0.000/-0.011
>18-20	+0.008/+0.029	0.000/-0.013

Unit(mm)

Workpiece Material				
P			K	
1 2 3 4	5	6 7	1 2	3
Carbon Steels, Alloy Steels (<35HRC)	Alloy Steels, Tool Steels (35-48HRC)	PH and Ferrite/Martensitic Stainless (<48HRC)	Grey Cast Iron, Nodular Cast Iron (<32HRC)	High Alloy Cast Iron (35-45HRC)
○	○	○	○	○

○ Most Suitable ○ Suitable

Recommended Cutting Data ※ P073

D938-A5N

5D External Cooling Twist Drills for Steel

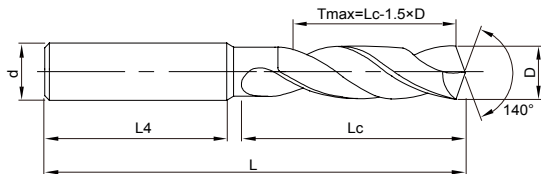

Tmax-Recommended Maximum Depth

» Continue

Ordering Code	D(m7)	Lc	L4	L	d(h6)	Stock
D938-A5N-1170	11.7	71	45	118	12	○
D938-A5N-1180	11.8	71	45	118	12	●
D938-A5N-1190	11.9	71	45	118	12	●
D938-A5N-1200	12.0	71	45	118	12	●
D938-A5N-1220	12.2	77	45	124	14	○
D938-A5N-1230	12.3	77	45	124	14	●
D938-A5N-1240	12.4	77	45	124	14	○
D938-A5N-1250	12.5	77	45	124	14	●
D938-A5N-1280	12.8	77	45	124	14	○
D938-A5N-1300	13.0	77	45	124	14	●
D938-A5N-1350	13.5	77	45	124	14	○
D938-A5N-1380	13.8	77	45	124	14	○
D938-A5N-1400	14.0	77	45	124	14	●
D938-A5N-1430	14.3	83	48	133	16	●
D938-A5N-1450	14.5	83	48	133	16	●
D938-A5N-1460	14.6	83	48	133	16	○

Ordering Code	D(m7)	Lc	L4	L	d(h6)	Stock
D938-A5N-1480	14.8	83	48	133	16	○
D938-A5N-1500	15.0	83	48	133	16	○
D938-A5N-1550	15.5	83	48	133	16	○
D938-A5N-1580	15.8	83	48	133	16	○
D938-A5N-1600	16.0	83	48	133	16	●
D938-A5N-1650	16.5	93	48	143	18	○
D938-A5N-1660	16.6	93	48	143	18	●
D938-A5N-1680	16.8	93	48	143	18	○
D938-A5N-1700	17.0	93	48	143	18	●
D938-A5N-1750	17.5	93	48	143	18	●
D938-A5N-1780	17.8	93	48	143	18	○
D938-A5N-1800	18.0	93	48	143	18	○
D938-A5N-1850	18.5	101	50	153	20	○
D938-A5N-1900	19.0	101	50	153	20	○
D938-A5N-1950	19.5	101	50	153	20	○
D938-A5N-2000	20.0	101	50	153	20	○

Note: Accept non-standard custom from D1 to D20 tool.

● Stock ○ Available upon Order

Nominal Size Range	D(m7)	d(h6)
≥2-3	+0.002/+0.012	0.000/-0.006
>3-6	+0.004/+0.016	0.000/-0.008
>6-10	+0.006/+0.021	0.000/-0.009
>10-18	+0.007/+0.025	0.000/-0.011
>18-20	+0.008/+0.029	0.000/-0.013

Unit(mm)

Workpiece Material				
P			K	
1 2 3 4	5	6 7	1 2	3
Carbon Steels, Alloy Steels (<35HRC)	Alloy Steels, Tool Steels (35-48HRC)	PH and Ferrite/Martensitic Stainless (<48HRC)	Grey Cast Iron, Nodular Cast Iron (<32HRC)	High Alloy Cast Iron (35-45HRC)
○	○	○	○	○

○ Most Suitable ○ Suitable

Recommended Cutting Data ※ P073

D938-A5C

5D Inner Cooling Twist Drills for Steel

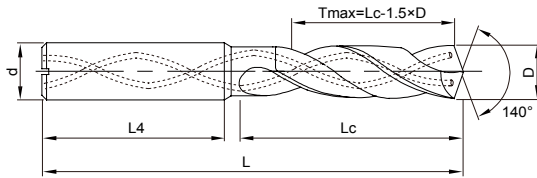

Tmax-Recommended Maximum Depth

Ordering Code	D(m7)	Lc	L4	L	d(h6)	Stock
D938-A5C-0300	3.00	28	36	66	6	●
D938-A5C-0310	3.10	28	36	66	6	●
D938-A5C-0320	3.20	28	36	66	6	●
D938-A5C-0330	3.30	28	36	66	6	●
D938-A5C-0340	3.40	28	36	66	6	●
D938-A5C-0350	3.50	28	36	66	6	●
D938-A5C-0360	3.60	28	36	66	6	●
D938-A5C-0370	3.70	28	36	66	6	●
D938-A5C-0380	3.80	36	36	74	6	●
D938-A5C-0390	3.90	36	36	74	6	●
D938-A5C-0400	4.00	36	36	74	6	●
D938-A5C-0410	4.10	36	36	74	6	●
D938-A5C-0420	4.20	36	36	74	6	●
D938-A5C-0430	4.30	36	36	74	6	●
D938-A5C-0440	4.40	36	36	74	6	●

Ordering Code	D(m7)	Lc	L4	L	d(h6)	Stock
D938-A5C-0450	4.50	36	36	74	6	●
D938-A5C-0460	4.60	36	36	74	6	●
D938-A5C-0465	4.65	36	36	74	6	●
D938-A5C-0470	4.70	36	36	74	6	●
D938-A5C-0480	4.80	44	36	82	6	●
D938-A5C-0490	4.90	44	36	82	6	●
D938-A5C-0500	5.00	44	36	82	6	●
D938-A5C-0510	5.10	44	36	82	6	●
D938-A5C-0520	5.20	44	36	82	6	●
D938-A5C-0530	5.30	44	36	82	6	●
D938-A5C-0540	5.40	44	36	82	6	●
D938-A5C-0550	5.50	44	36	82	6	●
D938-A5C-0555	5.55	44	36	82	6	●
D938-A5C-0560	5.60	44	36	82	6	●
D938-A5C-0570	5.70	44	36	82	6	●

Note: Accept non-standard Customization from D2 to D20 tool.

● Stock ○ Available upon Order

Nominal Size Range	D(m7)	d(h6)
≥2-3	+0.002/+0.012	0.000/-0.006
>3-6	+0.004/+0.016	0.000/-0.008
>6-10	+0.006/+0.021	0.000/-0.009
>10-18	+0.007/+0.025	0.000/-0.011
>18-20	+0.008/+0.029	0.000/-0.013

Unit(mm)

Workpiece Material				
P			K	
1 2 3 4	5	6 7	1 2	3
Carbon Steels, Alloy Steels (<35HRC)	Alloy Steels, Tool Steels (35-48HRC)	PH and Ferrite/Martensitic Stainless (<48HRC)	Grey Cast Iron, Nodular Cast Iron (<32HRC)	High Alloy Cast Iron (35-45HRC)
○	○	○	○	○

○ Most Suitable ○ Suitable

Recommended Cutting Data ※ P073

D938-A5C

5D Inner Cooling Twist Drills for Steel

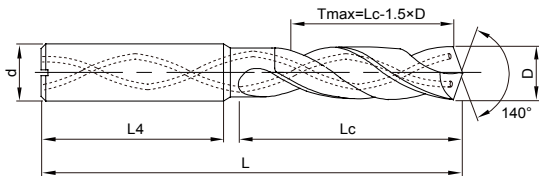

Tmax-Recommended Maximum Depth

» Continue

Ordering Code	D(m7)	Lc	L4	L	d(h6)	Stock
D938-A5C-0580	5.80	44	36	82	6	●
D938-A5C-0590	5.90	44	36	82	6	●
D938-A5C-0600	6.00	44	36	82	6	●
D938-A5C-0610	6.10	53	36	91	8	●
D938-A5C-0620	6.20	53	36	91	8	●
D938-A5C-0630	6.30	53	36	91	8	●
D938-A5C-0640	6.40	53	36	91	8	●
D938-A5C-0650	6.50	53	36	91	8	●
D938-A5C-0660	6.60	53	36	91	8	●
D938-A5C-0670	6.70	53	36	91	8	●
D938-A5C-0680	6.80	53	36	91	8	●
D938-A5C-0690	6.90	53	36	91	8	●
D938-A5C-0700	7.00	53	36	91	8	●
D938-A5C-0710	7.10	53	36	91	8	●
D938-A5C-0720	7.20	53	36	91	8	●

Ordering Code	D(m7)	Lc	L4	L	d(h6)	Stock
D938-A5C-0730	7.30	53	36	91	8	●
D938-A5C-0740	7.40	53	36	91	8	●
D938-A5C-0745	7.45	53	36	91	8	●
D938-A5C-0750	7.50	53	36	91	8	●
D938-A5C-0760	7.60	53	36	91	8	●
D938-A5C-0770	7.70	53	36	91	8	●
D938-A5C-0780	7.80	53	36	91	8	●
D938-A5C-0790	7.90	53	36	91	8	●
D938-A5C-0800	8.00	53	36	91	8	●
D938-A5C-0810	8.10	61	40	103	10	●
D938-A5C-0820	8.20	61	40	103	10	●
D938-A5C-0830	8.30	61	40	103	10	●
D938-A5C-0840	8.40	61	40	103	10	●
D938-A5C-0850	8.50	61	40	103	10	●
D938-A5C-0860	8.60	61	40	103	10	●

Note: Accept non-standard Customization from D2 to D20 tool.

● Stock ○ Available upon Order

Nominal Size Range	D(m7)	d(h6)
≥2-3	+0.002/+0.012	0.000/-0.006
>3-6	+0.004/+0.016	0.000/-0.008
>6-10	+0.006/+0.021	0.000/-0.009
>10-18	+0.007/+0.025	0.000/-0.011
>18-20	+0.008/+0.029	0.000/-0.013

Unit(mm)

Workpiece Material				
P			K	
1 2 3 4	5	6 7	1 2	3
Carbon Steels, Alloy Steels (<35HRC)	Alloy Steels, Tool Steels (35-48HRC)	PH and Ferrite/Martensitic Stainless (<48HRC)	Grey Cast Iron, Nodular Cast Iron (<32HRC)	High Alloy Cast Iron (35-45HRC)
○	○	○	○	○

○ Most Suitable ○ Suitable

Recommended Cutting Data ※ P073

D938-A5C

5D Inner Cooling Twist Drills for Steel

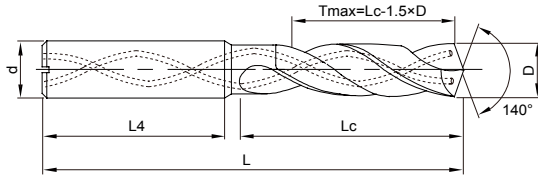

Tmax-Recommended Maximum Depth

» Continue

Ordering Code	D(m7)	Lc	L4	L	d(h6)	Stock
D938-A5C-0870	8.70	61	40	103	10	●
D938-A5C-0880	8.80	61	40	103	10	●
D938-A5C-0890	8.90	61	40	103	10	●
D938-A5C-0900	9.00	61	40	103	10	●
D938-A5C-0910	9.10	61	40	103	10	●
D938-A5C-0920	9.20	61	40	103	10	○
D938-A5C-0930	9.30	61	40	103	10	●
D938-A5C-0935	9.35	61	40	103	10	●
D938-A5C-0940	9.40	61	40	103	10	●
D938-A5C-0950	9.50	61	40	103	10	●
D938-A5C-0960	9.60	61	40	103	10	○
D938-A5C-0970	9.70	61	40	103	10	●
D938-A5C-0980	9.80	61	40	103	10	●
D938-A5C-0990	9.90	61	40	103	10	●
D938-A5C-1000	10.00	61	40	103	10	●

Ordering Code	D(m7)	Lc	L4	L	d(h6)	Stock
D938-A5C-1010	10.10	71	45	118	12	●
D938-A5C-1020	10.20	71	45	118	12	●
D938-A5C-1030	10.30	71	45	118	12	●
D938-A5C-1040	10.40	71	45	118	12	●
D938-A5C-1050	10.50	71	45	118	12	●
D938-A5C-1060	10.60	71	45	118	12	●
D938-A5C-1070	10.70	71	45	118	12	●
D938-A5C-1080	10.80	71	45	118	12	●
D938-A5C-1090	10.90	71	45	118	12	●
D938-A5C-1100	11.00	71	45	118	12	●
D938-A5C-1110	11.10	71	45	118	12	●
D938-A5C-1120	11.20	71	45	118	12	●
D938-A5C-1130	11.30	71	45	118	12	●
D938-A5C-1140	11.40	71	45	118	12	●
D938-A5C-1150	11.50	71	45	118	12	●

Note: Accept non-standard Customization from D2 to D20 tool.

● Stock ○ Available upon Order

Nominal Size Range	D(m7)	d(h6)
≥2-3	+0.002/+0.012	0.000/-0.006
>3-6	+0.004/+0.016	0.000/-0.008
>6-10	+0.006/+0.021	0.000/-0.009
>10-18	+0.007/+0.025	0.000/-0.011
>18-20	+0.008/+0.029	0.000/-0.013

Unit(mm)

Workpiece Material				
P			K	
1 2 3 4	5	6 7	1 2	3
Carbon Steels, Alloy Steels (<35HRC)	Alloy Steels, Tool Steels (35-48HRC)	PH and Ferrite/Martensitic Stainless (<48HRC)	Grey Cast Iron, Nodular Cast Iron (<32HRC)	High Alloy Cast Iron (35-45HRC)
○	○	○	○	○

○ Most Suitable ○ Suitable

Recommended Cutting Data ※ P073

D938-A5C

5D Inner Cooling Twist Drills for Steel

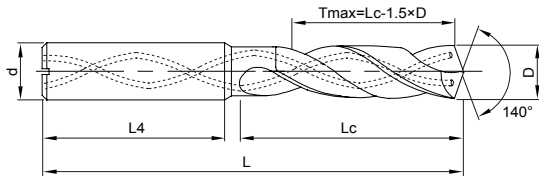

Tmax-Recommended Maximum Depth

» Continue

Ordering Code	D(m7)	Lc	L4	L	d(h6)	Stock
D938-A5C-1160	11.60	71	45	118	12	○
D938-A5C-1170	11.70	71	45	118	12	●
D938-A5C-1180	11.80	71	45	118	12	●
D938-A5C-1190	11.90	71	45	118	12	●
D938-A5C-1200	12.00	71	45	118	12	●
D938-A5C-1250	12.50	77	45	124	14	●
D938-A5C-1280	12.80	77	45	124	14	○
D938-A5C-1300	13.00	77	45	124	14	●
D938-A5C-1350	13.50	77	45	124	14	●
D938-A5C-1380	13.80	77	45	124	14	●
D938-A5C-1400	14.00	77	45	124	14	●
D938-A5C-1450	14.50	83	48	133	16	●
D938-A5C-1480	14.80	83	48	133	16	●
D938-A5C-1500	15.00	83	48	133	16	●
D938-A5C-1510	15.10	83	48	133	16	●

Ordering Code	D(m7)	Lc	L4	L	d(h6)	Stock
D938-A5C-1550	15.50	83	48	133	16	●
D938-A5C-1580	15.80	83	48	133	16	●
D938-A5C-1600	16.00	83	48	133	16	●
D938-A5C-1650	16.50	93	48	143	18	●
D938-A5C-1680	16.80	93	48	143	18	○
D938-A5C-1700	17.00	93	48	143	18	●
D938-A5C-1750	17.50	93	48	143	18	●
D938-A5C-1780	17.80	93	48	143	18	○
D938-A5C-1800	18.00	93	48	143	18	●
D938-A5C-1850	18.50	101	50	153	20	●
D938-A5C-1880	18.80	101	50	153	20	○
D938-A5C-1900	19.00	101	50	153	20	●
D938-A5C-1950	19.50	101	50	153	20	●
D938-A5C-1980	19.80	101	50	153	20	●
D938-A5C-2000	20.00	101	50	153	20	●

Note: Accept non-standard Customization from D2 to D20 tool.

● Stock ○ Available upon Order

Nominal Size Range	D(m7)	d(h6)
≥2-3	+0.002/+0.012	0.000/-0.006
>3-6	+0.004/+0.016	0.000/-0.008
>6-10	+0.006/+0.021	0.000/-0.009
>10-18	+0.007/+0.025	0.000/-0.011
>18-20	+0.008/+0.029	0.000/-0.013

Unit(mm)

Workpiece Material				
P			K	
1 2 3 4	5	6 7	1 2	3
Carbon Steels, Alloy Steels (<35HRC)	Alloy Steels, Tool Steels (35-48HRC)	PH and Ferrite/Martensitic Stainless (<48HRC)	Grey Cast Iron, Nodular Cast Iron (<32HRC)	High Alloy Cast Iron (35-45HRC)
○	○	○	○	○

○ Most Suitable ○ Suitable

Recommended Cutting Data ※ P373

D938-A8C

8D Inner Cooling Twist Drills for Steel

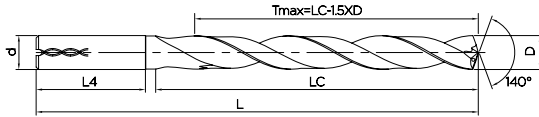

T_{max}-Recommended Maximum Depth

Ordering Code	D(m7)	Lc	L4	L	d(h6)	Stock
D938-A8C-0300	3.00	34	36	72	6	●
D938-A8C-0310	3.10	34	36	72	6	●
D938-A8C-0320	3.20	34	36	72	6	●
D938-A8C-0330	3.30	34	36	72	6	●
D938-A8C-0340	3.40	34	36	72	6	●
D938-A8C-0350	3.50	34	36	72	6	●
D938-A8C-0360	3.60	34	36	72	6	●
D938-A8C-0370	3.70	34	36	72	6	○
D938-A8C-0380	3.80	43	36	81	6	○
D938-A8C-0390	3.90	43	36	81	6	●
D938-A8C-0400	4.00	43	36	81	6	●
D938-A8C-0410	4.10	43	36	81	6	●
D938-A8C-0420	4.20	43	36	81	6	●
D938-A8C-0430	4.30	43	36	81	6	○
D938-A8C-0440	4.40	43	36	81	6	○

Ordering Code	D(m7)	Lc	L4	L	d(h6)	Stock
D938-A8C-0450	4.50	43	36	81	6	●
D938-A8C-0460	4.60	43	36	81	6	○
D938-A8C-0470	4.70	43	36	81	6	○
D938-A8C-0480	4.80	57	36	95	6	○
D938-A8C-0490	4.90	57	36	95	6	○
D938-A8C-0500	5.00	57	36	95	6	●
D938-A8C-0510	5.10	57	36	95	6	●
D938-A8C-0520	5.20	57	36	95	6	●
D938-A8C-0530	5.30	57	36	95	6	○
D938-A8C-0540	5.40	57	36	95	6	○
D938-A8C-0550	5.50	57	36	95	6	●
D938-A8C-0560	5.60	57	36	95	6	○
D938-A8C-0570	5.70	57	36	95	6	○
D938-A8C-0580	5.80	57	36	95	6	●
D938-A8C-0590	5.90	57	36	95	6	○

Note: Accept non-standard custom from D3 to D20 tool.

● Stock ○ Available upon Order

Nominal Size Range	D(m7)	d(h6)
≥2—3	+0.002/+0.012	0.000/-0.006
>3—6	+0.004/+0.016	0.000/-0.008
>6—10	+0.006/+0.021	0.000/-0.009
>10—18	+0.007/+0.025	0.000/-0.011
>18—20	+0.008/+0.029	0.000/-0.013

Unit(mm)

Workpiece Material					
P			M	K	
1 2 3 4	5	6 7	1 2 3	1 2	3
Carbon Steels, Alloy Steels (<35HRC)	Alloy Steels, Tool Steels (35-48HRC)	PH and Ferrite/Martensitic Stainless (<48HRC)	Stainless Steel	Grey Cast Iron, Nodular Cast Iron (<32HRC)	High Alloy Cast Iron (35-45HRC)
○	○	○	○	○	○

○ Most Suitable ○ Suitable

Recommended Cutting Data ※ P075

D938-A8C

8D Inner Cooling Twist Drills for Steel

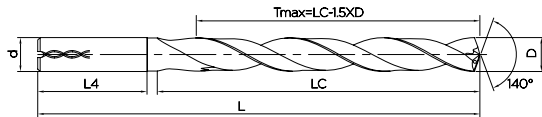

T_{max}-Recommended Maximum Depth

» Continue

Ordering Code	D(m7)	Lc	L4	L	d(h6)	Stock
D938-A8C-0600	6.00	57	36	95	6	●
D938-A8C-0610	6.10	76	36	114	8	●
D938-A8C-0620	6.20	76	36	114	8	○
D938-A8C-0630	6.30	76	36	114	8	○
D938-A8C-0640	6.40	76	36	114	8	○
D938-A8C-0650	6.50	76	36	114	8	●
D938-A8C-0660	6.60	76	36	114	8	●
D938-A8C-0670	6.70	76	36	114	8	○
D938-A8C-0680	6.80	76	36	114	8	●
D938-A8C-0690	6.90	76	36	114	8	●
D938-A8C-0700	7.00	76	36	114	8	●
D938-A8C-0710	7.10	76	36	114	8	●
D938-A8C-0720	7.20	76	36	114	8	○
D938-A8C-0730	7.30	76	36	114	8	○

Ordering Code	D(m7)	Lc	L4	L	d(h6)	Stock
D938-A8C-0740	7.40	76	36	114	8	●
D938-A8C-0750	7.50	76	36	114	8	●
D938-A8C-0760	7.60	76	36	114	8	○
D938-A8C-0770	7.70	76	36	114	8	○
D938-A8C-0780	7.80	76	36	114	8	○
D938-A8C-0790	7.90	76	36	114	8	●
D938-A8C-0800	8.00	76	36	114	8	●
D938-A8C-0810	8.10	95	40	142	10	○
D938-A8C-0820	8.20	95	40	142	10	●
D938-A8C-0830	8.30	95	40	142	10	○
D938-A8C-0840	8.40	95	40	142	10	○
D938-A8C-0850	8.50	95	40	142	10	●
D938-A8C-0860	8.60	95	40	142	10	○
D938-A8C-0870	8.70	95	40	142	10	●

Note: Accept non-standard custom from D3 to D20 tool.

● Stock ○ Available upon Order

Nominal Size Range	D(m7)	d(h6)
≥2-3	+0.002/+0.012	0.000/-0.006
>3-6	+0.004/+0.016	0.000/-0.008
>6-10	+0.006/+0.021	0.000/-0.009
>10-18	+0.007/+0.025	0.000/-0.011
>18-20	+0.008/+0.029	0.000/-0.013

Unit(mm)

Workpiece Material					
P			M	K	
1 2 3 4	5	6 7	1 2 3	1 2	3
Carbon Steels, Alloy Steels (<35HRC)	Alloy Steels, Tool Steels (35-48HRC)	PH and Ferrite/Martensitic Stainless (<48HRC)	Stainless Steel	Grey Cast Iron, Nodular Cast Iron (<32HRC)	High Alloy Cast Iron (35-45HRC)
○	○	○	○	○	○

○ Most Suitable ○ Suitable

Recommended Cutting Data ※ P075

D938-A8C

8D Inner Cooling Twist Drills for Steel

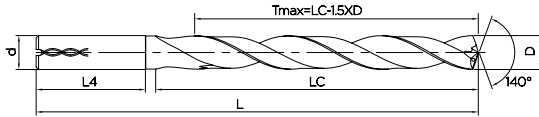

Tmax-Recommended Maximum Depth

» Continue

Ordering Code	D(m7)	Lc	L4	L	d(h6)	Stock
D938-A8C-0880	8.80	95	40	142	10	●
D938-A8C-0890	8.90	95	40	142	10	○
D938-A8C-0900	9.00	95	40	142	10	●
D938-A8C-0930	9.30	95	40	142	10	●
D938-A8C-0950	9.50	95	40	142	10	●
D938-A8C-0980	9.80	95	40	142	10	○
D938-A8C-1000	10.00	95	40	142	10	●
D938-A8C-1020	10.20	114	45	162	12	●
D938-A8C-1030	10.30	114	45	162	12	○
D938-A8C-1050	10.50	114	45	162	12	●
D938-A8C-1080	10.80	114	45	162	12	●
D938-A8C-1100	11.00	114	45	162	12	●
D938-A8C-1120	11.20	114	45	162	12	●
D938-A8C-1150	11.50	114	45	162	12	○
D938-A8C-1180	11.80	114	45	162	12	●

Ordering Code	D(m7)	Lc	L4	L	d(h6)	Stock
D938-A8C-1200	12.00	114	45	162	12	●
D938-A8C-1220	12.20	133	45	182	14	○
D938-A8C-1250	12.50	133	45	182	14	●
D938-A8C-1280	12.80	133	45	182	14	○
D938-A8C-1300	13.00	133	45	182	14	●
D938-A8C-1350	13.50	133	45	182	14	●
D938-A8C-1380	13.80	133	45	182	14	●
D938-A8C-1400	14.00	133	45	182	14	●
D938-A8C-1420	14.20	152	48	203	16	○
D938-A8C-1450	14.50	152	48	203	16	○
D938-A8C-1480	14.80	152	48	203	16	●
D938-A8C-1500	15.00	152	48	203	16	●
D938-A8C-1550	15.50	152	48	203	16	●
D938-A8C-1580	15.80	152	48	203	16	●
D938-A8C-1600	16.00	152	48	203	16	●

Note: Accept non-standard custom from D3 to D20 tool.

● Stock ○ Available upon Order

Nominal Size Range	D(m7)	d(h6)
≥2-3	+0.002/+0.012	0.000/-0.006
>3-6	+0.004/+0.016	0.000/-0.008
>6-10	+0.006/+0.021	0.000/-0.009
>10-18	+0.007/+0.025	0.000/-0.011
>18-20	+0.008/+0.029	0.000/-0.013

Unit(mm)

Workpiece Material					
P			M	K	
1 2 3 4	5	6 7	1 2 3	1 2	3
Carbon Steels, Alloy Steels (<35HRC)	Alloy Steels, Tool Steels (35-48HRC)	PH and Ferrite/Martensitic Stainless (<48HRC)	Stainless Steel	Grey Cast Iron, Nodular Cast Iron (<32HRC)	High Alloy Cast Iron (35-45HRC)
○	○	○	○	○	○

○ Most Suitable ○ Suitable

Recommended Cutting Data ※ P075

D938-A12C NEW

12D Twist deep Drills for Steel

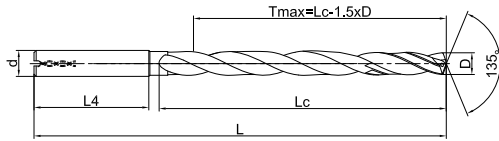

T_{max}-Recommended Maximum Depth

Ordering Code	D(h7)	Lc	L4	L	d(h6)	Stock
D938-A12C-0300	3	54	36	92	6	○
D938-A12C-0330	3.3	54	36	92	6	○
D938-A12C-0350	3.5	54	36	92	6	●
D938-A12C-0400	4	64	36	102	6	○
D938-A12C-0460	4.6	64	36	102	6	●
D938-A12C-0470	4.7	64	36	102	6	●
D938-A12C-0450	4.8	83	36	121	6	○
D938-A12C-0500	5	83	36	121	6	●
D938-A12C-0550	5.5	83	36	121	6	●
D938-A12C-0560	5.6	83	36	121	6	○
D938-A12C-0600	6	83	36	121	6	○
D938-A12C-0610	6.1	110	36	148	8	○
D938-A12C-0630	6.3	110	36	148	8	○
D938-A12C-0650	6.5	110	36	148	8	○
D938-A12C-0680	6.8	110	36	148	8	○

Ordering Code	D(h7)	Lc	L4	L	d(h6)	Stock
D938-A12C-0700	7	110	36	148	8	○
D938-A12C-0800	8	110	36	148	8	●
D938-A12C-0850	8.5	138	40	180	10	○
D938-A12C-0900	9	138	40	180	10	○
D938-A12C-0980	9.8	138	40	180	10	○
D938-A12C-1000	10	138	40	180	10	○
D938-A12C-1050	10.5	158	45	206	12	○
D938-A12C-1100	11	158	45	206	12	○
D938-A12C-1200	12	158	45	206	12	●
D938-A12C-1250	12.5	182	45	230	14	○
D938-A12C-1300	13	182	45	230	14	○
D938-A12C-1400	14	182	45	230	14	○
D938-A12C-1450	14.5	208	48	230	16	○
D938-A12C-1500	15	208	48	230	16	○
D938-A12C-1600	16	208	48	230	16	○

Note: Accept non-standard custom from D3 to D20 tool.

● Stock ○ Available upon Order

Nominal Size Range	D(h7)	d(h6)
>3-6	0.000/-0.012	0.000/-0.008
>6-10	0.000/-0.015	0.000/-0.009
>10-18	0.000/-0.018	0.000/-0.011
>18-20	0.000/-0.021	0.000/-0.013

Unit(mm)

Workpiece Material					
P			M	K	
1 2 3 4	5	6 7	1 2 3	1 2	3
Carbon Steels, Alloy Steels (<35HRC)	Alloy Steels, Tool Steels (35-48HRC)	PH and Ferrite/Martensitic Stainless (<48HRC)	Stainless Steel	Grey Cast Iron, Nodular Cast Iron (<32HRC)	High Alloy Cast Iron (35-45HRC)
◎	◎	○	○	○	○

◎ Most Suitable ○ Suitable

Recommended Cutting Data ※ P075

D938-A15C NEW

15D Twist deep Drills for Steel

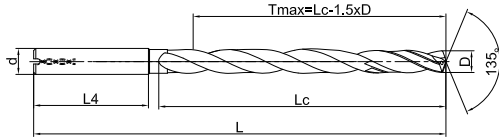

Tmax-Recommended Maximum Depth

Ordering Code	D(h7)	Lc	L4	L	d(h6)	Stock
D938-A15C-0300	3	55	36	95	6	○
D938-A15C-0330	3.3	67	36	106	6	○
D938-A15C-0350	3.5	76	36	116	6	○
D938-A15C-0380	3.8	76	36	116	6	○
D938-A15C-0400	4	76	36	116	6	○
D938-A15C-0420	4.2	93	36	133	6	○
D938-A15C-0450	4.5	93	36	133	6	○
D938-A15C-0450	4.8	93	36	133	6	○
D938-A15C-0500	5	93	36	133	6	○
D938-A15C-0550	5.5	110	36	150	6	○
D938-A15C-0560	5.6	110	36	150	6	○
D938-A15C-0600	6	110	36	150	6	○
D938-A15C-0610	6.1	127	36	167	8	○
D938-A15C-0630	6.3	127	36	167	8	○

Ordering Code	D(h7)	Lc	L4	L	d(h6)	Stock
D938-A15C-0650	6.5	127	36	167	8	○
D938-A15C-0680	6.8	127	36	167	8	○
D938-A15C-0700	7	127	36	167	8	○
D938-A15C-0800	8	143	36	183	8	●
D938-A15C-0850	8.5	160	40	204	10	○
D938-A15C-0900	9	160	40	204	10	●
D938-A15C-0980	9.8	177	40	221	10	○
D938-A15C-1000	10	177	40	221	10	○
D938-A15C-1050	10.5	198	45	247	12	○
D938-A15C-1100	11	198	45	247	12	○
D938-A15C-1200	12	214	45	263	12	○
D938-A15C-1250	12.5	248	45	297	14	○
D938-A15C-1300	13	248	45	297	14	○
D938-A15C-1400	14	248	45	297	14	○

Note: Accept non-standard custom from D3 to D20 tool.

● Stock ○ Available upon Order

Nominal Size Range	D(h7)	d(h6)
>3-6	0.000/-0.012	0.000/-0.008
>6-10	0.000/-0.015	0.000/-0.009
>10-18	0.000/-0.018	0.000/-0.011
>18-20	0.000/-0.021	0.000/-0.013

Unit(mm)

Workpiece Material					
P			M	K	
1 2 3 4	5	6 7	1 2 3	1 2	3
Carbon Steels, Alloy Steels (<35HRC)	Alloy Steels, Tool Steels (35-48HRC)	PH and Ferrite/Martensitic Stainless (<48HRC)	Stainless Steel	Grey Cast Iron, Nodular Cast Iron (<32HRC)	High Alloy Cast Iron (35-45HRC)
○	○	○	○	○	○

○ Most Suitable ○ Suitable

Recommended Cutting Data ※ P075

D918-A3N

3D External Cooling Twist Drills for General Purpose

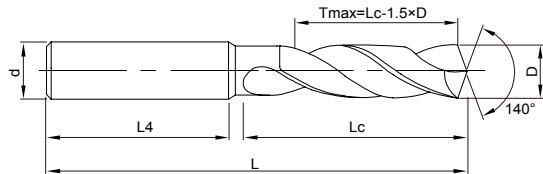

Tmax-Recommended Maximum Depth

Ordering Code	D(m7)	Lc	L4	L	d(h6)	Stock
D918-A3N-0300	3.00	20	36	62	6	○
D918-A3N-0325	3.25	20	36	62	6	○
D918-A3N-0330	3.30	20	36	62	6	●
D918-A3N-0340	3.40	20	36	62	6	○
D918-A3N-0350	3.50	20	36	62	6	○
D918-A3N-0370	3.70	20	36	62	6	○
D918-A3N-0400	4.00	24	36	66	6	○
D918-A3N-0420	4.20	24	36	66	6	●
D918-A3N-0430	4.30	24	36	66	6	○
D918-A3N-0450	4.50	24	36	66	6	●
D918-A3N-0465	4.65	24	36	66	6	○
D918-A3N-0480	4.80	28	36	66	6	○
D918-A3N-0500	5.00	28	36	66	6	○
D918-A3N-0510	5.10	28	36	66	6	●
D918-A3N-0520	5.20	28	36	66	6	●

Ordering Code	D(m7)	Lc	L4	L	d(h6)	Stock
D918-A3N-0550	5.50	28	36	66	6	●
D918-A3N-0560	5.60	28	36	66	6	●
D918-A3N-0580	5.80	28	36	66	6	●
D918-A3N-0600	6.00	28	36	66	6	●
D918-A3N-0610	6.10	34	36	79	8	○
D918-A3N-0620	6.20	34	36	79	8	●
D918-A3N-0630	6.30	34	36	79	8	●
D918-A3N-0650	6.50	34	36	79	8	○
D918-A3N-0660	6.60	34	36	79	8	●
D918-A3N-0680	6.80	34	36	79	8	○
D918-A3N-0690	6.90	34	36	79	8	●
D918-A3N-0700	7.00	34	36	79	8	●
D918-A3N-0720	7.20	41	36	79	8	●
D918-A3N-0740	7.40	41	36	79	8	○
D918-A3N-0750	7.50	41	36	79	8	○

Note: Accept non-standard Customization from D2 to D20 tool.

● Stock ○ Available upon Order

Nominal Size Range	D(m7)	d(h6)
≥2-3	+0.002/+0.012	0.000/-0.006
>3-6	+0.004/+0.016	0.000/-0.008
>6-10	+0.006/+0.021	0.000/-0.009
>10-18	+0.007/+0.025	0.000/-0.011
>18-20	+0.008/+0.029	0.000/-0.013

Unit(mm)

Workpiece Material								
P			M	K		N		
1 2 3 4	5	6	1 2 3	1 2	3	1 2	3	4
Carbon Steels, Alloy Steels (<35HRC)	Alloy Steels, Tool Steels (35-48HRC)	PH and Ferrite/ Martensitic Stainless (<48HRC)	Stainless Steel	Grey Cast Iron, Nodular Cast Iron (<32HRC)	High Alloy Cast Iron (35-45HRC)	Wrought Aluminium Alloys, Cast Aluminium Alloys (Si≤12%)	Cast Aluminium Alloys (Si>12%)	Copper Alloys (<200HB)
○	○	○		○	○			

○ Most Suitable ○ Suitable

Recommended Cutting Data ※ P079

D918-A3N

3D External Cooling Twist Drills for General Purpose

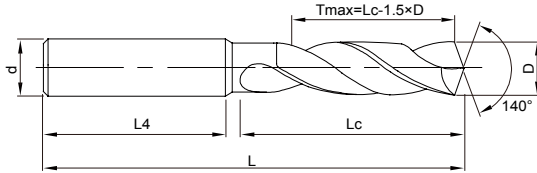

Tmax-Recommended Maximum Depth

» Continue

Ordering Code	D(m7)	Lc	L4	L	d(h6)	Stock
D918-A3N-0780	7.80	41	36	79	8	○
D918-A3N-0800	8.00	41	36	79	8	●
D918-A3N-0810	8.10	47	40	89	10	○
D918-A3N-0840	8.40	47	40	89	10	●
D918-A3N-0850	8.50	47	40	89	10	●
D918-A3N-0860	8.60	47	40	89	10	○
D918-A3N-0870	8.70	47	40	89	10	○
D918-A3N-0880	8.80	47	40	89	10	○
D918-A3N-0900	9.00	47	40	89	10	○
D918-A3N-0930	9.30	47	40	89	10	○
D918-A3N-0950	9.50	47	40	89	10	●
D918-A3N-0960	9.60	47	40	89	10	○
D918-A3N-0980	9.80	47	40	89	10	○
D918-A3N-1000	10.00	47	40	89	10	○
D918-A3N-1025	10.25	55	45	102	12	●

Ordering Code	D(m7)	Lc	L4	L	d(h6)	Stock
D918-A3N-1040	10.40	55	45	102	12	○
D918-A3N-1050	10.50	55	45	102	12	○
D918-A3N-1060	10.60	55	45	102	12	○
D918-A3N-1080	10.80	55	45	102	12	●
D918-A3N-1100	11.00	55	45	102	12	●
D918-A3N-1120	11.20	55	45	102	12	○
D918-A3N-1150	11.50	55	45	102	12	○
D918-A3N-1180	11.80	55	45	102	12	○
D918-A3N-1200	12.00	55	45	102	12	○
D918-A3N-1225	12.25	60	45	107	14	○
D918-A3N-1250	12.50	60	45	107	14	●
D918-A3N-1270	12.70	60	45	107	14	○
D918-A3N-1275	12.75	60	45	107	14	●
D918-A3N-1280	12.80	60	45	107	14	○
D918-A3N-1300	13.00	60	45	107	14	●

Note: Accept non-standard Customization from D2 to D20 tool.

● Stock ○ Available upon Order

Nominal Size Range	D(m7)	d(h6)
≥2-3	+0.002/+0.012	0.000/-0.006
>3-6	+0.004/+0.016	0.000/-0.008
>6-10	+0.006/+0.021	0.000/-0.009
>10-18	+0.007/+0.025	0.000/-0.011
>18-20	+0.008/+0.029	0.000/-0.013

Unit(mm)

Workpiece Material								
P			M	K			N	
1 2 3 4	5	6	1 2 3	1 2	3	1 2	3	4
Carbon Steels, Alloy Steels (<35HRC)	Alloy Steels, Tool Steels (35-48HRC)	PH and Ferrite/ Martensitic Stainless (<48HRC)	Stainless Steel	Grey Cast Iron, Nodular Cast Iron (<32HRC)	High Alloy Cast Iron (35-45HRC)	Wrought Aluminium Alloys, Cast Aluminium Alloys (Si≤12%)	Cast Aluminium Alloys (Si>12%)	Copper Alloys (<200HB)
○	○	○		○	○			

○ Most Suitable ○ Suitable

Recommended Cutting Data ※ P076

D918-A3N

3D External Cooling Twist Drills for General Purpose

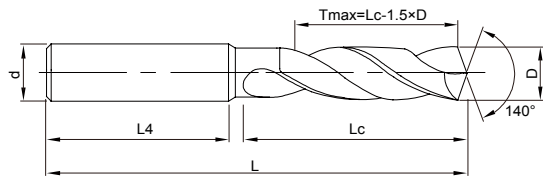

Tmax-Recommended Maximum Depth

» Continue

Ordering Code	D(m7)	Lc	L4	L	d(h6)	Stock
D918-A3N-1310	13.10	60	45	107	14	○
D918-A3N-1350	13.50	60	45	107	14	○
D918-A3N-1380	13.80	60	45	107	14	○
D918-A3N-1400	14.00	60	45	107	14	○
D918-A3N-1425	14.25	65	48	115	16	○
D918-A3N-1450	14.50	65	48	115	16	●
D918-A3N-1475	14.75	65	48	115	16	●
D918-A3N-1480	14.80	65	48	115	16	○
D918-A3N-1500	15.00	65	48	115	16	○
D918-A3N-1510	15.10	65	48	115	16	○
D918-A3N-1550	15.50	65	48	115	16	○
D918-A3N-1580	15.80	65	48	115	16	○
D918-A3N-1600	16.00	65	48	115	16	○

Ordering Code	D(m7)	Lc	L4	L	d(h6)	Stock
D918-A3N-1650	16.50	73	48	123	18	○
D918-A3N-1675	16.75	73	48	123	18	○
D918-A3N-1680	16.80	73	48	123	18	○
D918-A3N-1700	17.00	73	48	123	18	○
D918-A3N-1750	17.50	73	48	123	18	●
D918-A3N-1780	17.80	73	48	123	18	○
D918-A3N-1800	18.00	73	48	123	18	○
D918-A3N-1850	18.50	79	50	131	20	○
D918-A3N-1880	18.80	79	50	131	20	○
D918-A3N-1900	19.00	79	50	131	20	○
D918-A3N-1950	19.50	79	50	131	20	○
D918-A3N-1980	19.80	79	50	131	20	○
D918-A3N-2000	20.00	79	50	131	20	○

Note: Accept non-standard custom from D2 to D20 tool.

● Stock ○ Available upon Order

Nominal Size Range	D(m7)	d(h6)
≥2-3	+0.002/+0.012	0.000/-0.006
>3-6	+0.004/+0.016	0.000/-0.008
>6-10	+0.006/+0.021	0.000/-0.009
>10-18	+0.007/+0.025	0.000/-0.011
>18-20	+0.008/+0.029	0.000/-0.013

Unit(mm)

Workpiece Material								
P			M	K			N	
1 2 3 4	5	6	1 2 3	1 2	3	1 2	3	4
Carbon Steels, Alloy Steels (<35HRC)	Alloy Steels, Tool Steels (35-48HRC)	PH and Ferrite/ Martensitic Stainless (<48HRC)	Stainless Steel	Grey Cast Iron, Nodular Cast Iron (<32HRC)	High Alloy Cast Iron (35-45HRC)	Wrought Aluminium Alloys, Cast Aluminium Alloys (Si≤12%)	Cast Aluminium Alloys (Si>12%)	Copper Alloys (<200HB)
○	○	○		○	○			

○ Most Suitable ○ Suitable

Recommended Cutting Data ※ P079

D918-A3C

3D Inner Cooling Twist Drills for General Purpose

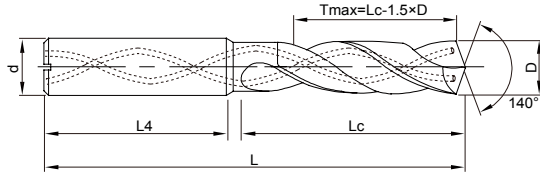

Tmax-Recommended Maximum Depth

Ordering Code	D(m7)	Lc	L4	L	d(h6)	Stock
D918-A3C-0500	5.00	28	36	66	6	○
D918-A3C-0510	5.10	28	36	66	6	○
D918-A3C-0520	5.20	28	36	66	6	○
D918-A3C-0550	5.50	28	36	66	6	○
D918-A3C-0555	5.55	28	36	66	6	○
D918-A3C-0580	5.80	28	36	66	6	○
D918-A3C-0600	6.00	28	36	66	6	○
D918-A3C-0610	6.10	34	36	79	8	○
D918-A3C-0620	6.20	34	36	79	8	○
D918-A3C-0630	6.30	34	36	79	8	○
D918-A3C-0650	6.50	34	36	79	8	○
D918-A3C-0660	6.60	34	36	79	8	●
D918-A3C-0680	6.80	34	36	79	8	○
D918-A3C-0690	6.90	34	36	79	8	○
D918-A3C-0700	7.00	34	36	79	8	○

Ordering Code	D(m7)	Lc	L4	L	d(h6)	Stock
D918-A3C-0710	7.10	41	36	79	8	○
D918-A3C-0740	7.40	41	36	79	8	○
D918-A3C-0750	7.50	41	36	79	8	○
D918-A3C-0780	7.80	41	36	79	8	○
D918-A3C-0800	8.00	41	36	79	8	○
D918-A3C-0810	8.10	47	40	89	10	○
D918-A3C-0840	8.40	47	40	89	10	○
D918-A3C-0850	8.50	47	40	89	10	○
D918-A3C-0860	8.60	47	40	89	10	○
D918-A3C-0870	8.70	47	40	89	10	○
D918-A3C-0880	8.80	47	40	89	10	○
D918-A3C-0900	9.00	47	40	89	10	●
D918-A3C-0930	9.30	47	40	89	10	○
D918-A3C-0950	9.50	47	40	89	10	○
D918-A3C-0960	9.60	47	40	89	10	○

Note: Accept non-standard custom from D3 to D20 tool.

● Stock ○ Available upon Order

Nominal Size Range	D(m7)	d(h6)
≥2-3	+0.002/+0.012	0.000/-0.006
>3-6	+0.004/+0.016	0.000/-0.008
>6-10	+0.006/+0.021	0.000/-0.009
>10-18	+0.007/+0.025	0.000/-0.011
>18-20	+0.008/+0.029	0.000/-0.013

Unit(mm)

Workpiece Material								
P			M	K	N			
1 2 3 4	5	6	1 2 3	1 2	3	1 2	3	4
Carbon Steels, Alloy Steels (<35HRC)	Alloy Steels, Tool Steels (35-48HRC)	PH and Ferrite/ Martensitic Stainless (<48HRC)	Stainless Steel	Grey Cast Iron, Nodular Cast Iron (<32HRC)	High Alloy Cast Iron (35-45HRC)	Wrought Aluminium Alloys, Cast Aluminium Alloys (Si≤12%)	Cast Aluminium Alloys (Si>12%)	Copper Alloys (<200HB)
○	○	○	○	○	○	○	○	○

○ Most Suitable ○ Suitable

Recommended Cutting Data ※ P079

D918-A3C

3D Inner Cooling Twist Drills for General Purpose

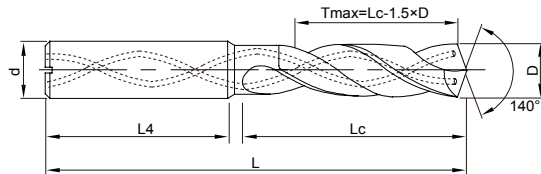

Tmax-Recommended Maximum Depth

» Continue

Ordering Code	D(m7)	Lc	L4	L	d(h6)	Stock
D918-A3C-0980	9.80	47	40	89	10	○
D918-A3C-1000	10.00	47	40	89	10	○
D918-A3C-1025	10.25	55	45	102	12	●
D918-A3C-1040	10.40	55	45	102	12	○
D918-A3C-1050	10.50	55	45	102	12	○
D918-A3C-1060	10.60	55	45	102	12	○
D918-A3C-1080	10.80	55	45	102	12	○
D918-A3C-1100	11.00	55	45	102	12	○
D918-A3C-1120	11.20	55	45	102	12	○
D918-A3C-1150	11.50	55	45	102	12	○
D918-A3C-1180	11.80	55	45	102	12	○
D918-A3C-1200	12.00	55	45	102	12	●
D918-A3C-1225	12.25	60	45	107	14	○
D918-A3C-1250	12.50	60	45	107	14	○
D918-A3C-1270	12.70	60	45	107	14	○

Ordering Code	D(m7)	Lc	L4	L	d(h6)	Stock
D918-A3C-1275	12.75	60	45	107	14	○
D918-A3C-1280	12.80	60	45	107	14	○
D918-A3C-1300	13.00	60	45	107	14	○
D918-A3C-1310	13.10	60	45	107	14	○
D918-A3C-1350	13.50	60	45	107	14	○
D918-A3C-1380	13.80	60	45	107	14	○
D918-A3C-1400	14.00	60	45	107	14	○
D918-A3C-1425	14.25	65	48	115	16	○
D918-A3C-1450	14.50	65	48	115	16	○
D918-A3C-1475	14.75	65	48	115	16	○
D918-A3C-1480	14.80	65	48	115	16	○
D918-A3C-1500	15.00	65	48	115	16	○
D918-A3C-1510	15.10	65	48	115	16	○
D918-A3C-1550	15.50	65	48	115	16	●
D918-A3C-1580	15.80	65	48	115	16	○
D918-A3C-1600	16.00	65	48	115	16	○

Note: Accept non-standard custom from D3 to D20 tool.

● Stock ○ Available upon Order

Nominal Size Range	D(m7)	d(h6)
≥2-3	+0.002/+0.012	0.000/-0.006
>3-6	+0.004/+0.016	0.000/-0.008
>6-10	+0.006/+0.021	0.000/-0.009
>10-18	+0.007/+0.025	0.000/-0.011
>18-20	+0.008/+0.029	0.000/-0.013

Unit(mm)

Workpiece Material								
P			M	K			N	
1 2 3 4	5	6	1 2 3	1 2	3	1 2	3	4
Carbon Steels, Alloy Steels (<35HRC)	Alloy Steels, Tool Steels (35-48HRC)	PH and Ferrite/ Martensitic Stainless (<48HRC)	Stainless Steel	Grey Cast Iron, Nodular Cast Iron (<32HRC)	High Alloy Cast Iron (35-45HRC)	Wrought Aluminium Alloys, Cast Aluminium Alloys (Si≤12%)	Cast Aluminium Alloys (Si>12%)	Copper Alloys (<200HB)
○	○	○	○	○	○	○	○	○

○ Most Suitable ○ Suitable

Recommended Cutting Data ※ P079

D918-A5N

5D External Cooling Twist Drills for General Purpose

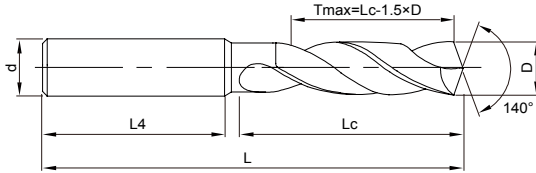

Tmax-Recommended Maximum Depth

Ordering Code	D(m7)	Lc	L4	L	d(h6)	Stock
D918-A5N-0300	3.00	28	36	66	6	●
D918-A5N-0325	3.25	28	36	66	6	○
D918-A5N-0330	3.30	28	36	66	6	○
D918-A5N-0340	3.40	28	36	66	6	●
D918-A5N-0350	3.50	28	36	66	6	●
D918-A5N-0370	3.70	28	36	66	6	○
D918-A5N-0400	4.00	36	36	74	6	○
D918-A5N-0420	4.20	36	36	74	6	●
D918-A5N-0430	4.30	36	36	74	6	●
D918-A5N-0450	4.50	36	36	74	6	○
D918-A5N-0465	4.65	36	36	74	6	○
D918-A5N-0480	4.80	44	36	82	6	○
D918-A5N-0500	5.00	44	36	82	6	●
D918-A5N-0510	5.10	44	36	82	6	●
D918-A5N-0520	5.20	44	36	82	6	●

Ordering Code	D(m7)	Lc	L4	L	d(h6)	Stock
D918-A5N-0550	5.50	44	36	82	6	●
D918-A5N-0555	5.55	44	36	82	6	●
D918-A5N-0580	5.80	44	36	82	6	●
D918-A5N-0600	6.00	44	36	82	6	●
D918-A5N-0610	6.10	53	36	91	8	○
D918-A5N-0620	6.20	53	36	91	8	●
D918-A5N-0630	6.30	53	36	91	8	○
D918-A5N-0650	6.50	53	36	91	8	○
D918-A5N-0660	6.60	53	36	91	8	○
D918-A5N-0680	6.80	53	36	91	8	●
D918-A5N-0690	6.90	53	36	91	8	○
D918-A5N-0700	7.00	53	36	91	8	●
D918-A5N-0710	7.10	53	36	91	8	○
D918-A5N-0740	7.40	53	36	91	8	○
D918-A5N-0750	7.50	53	36	91	8	○

Note: Accept non-standard Customization from D2 to D20 tool.

● Stock ○ Available upon Order

Nominal Size Range	D(m7)	d(h6)
≥2-3	+0.002/+0.012	0.000/-0.006
>3-6	+0.004/+0.016	0.000/-0.008
>6-10	+0.006/+0.021	0.000/-0.009
>10-18	+0.007/+0.025	0.000/-0.011
>18-20	+0.008/+0.029	0.000/-0.013

Unit(mm)

Workpiece Material								
P			M	K			N	
1 2 3 4	5	6	1 2 3	1 2	3	1 2	3	4
Carbon Steels, Alloy Steels (<35HRC)	Alloy Steels, Tool Steels (35-48HRC)	PH and Ferrite/ Martensitic Stainless (<48HRC)	Stainless Steel	Grey Cast Iron, Nodular Cast Iron (<32HRC)	High Alloy Cast Iron (35-45HRC)	Wrought Aluminium Alloys, Cast Aluminium Alloys (Si≤12%)	Cast Aluminium Alloys (Si>12%)	Copper Alloys (<200HB)
○	○	○		○	○			

○ Most Suitable ○ Suitable

Recommended Cutting Data ※ P079

D918-A5N



5D External Cooling Twist Drills for General Purpose

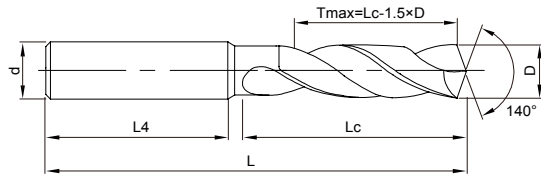

Tmax-Recommended Maximum Depth

» Continue

Ordering Code	D(m7)	Lc	L4	L	d(h6)	Stock
D918-A5N-0780	7.80	53	36	91	8	○
D918-A5N-0800	8.00	53	36	91	8	○
D918-A5N-0810	8.10	61	40	103	10	●
D918-A5N-0840	8.40	61	40	103	10	○
D918-A5N-0850	8.50	61	40	103	10	●
D918-A5N-0860	8.60	61	40	103	10	○
D918-A5N-0870	8.70	61	40	103	10	●
D918-A5N-0880	8.80	61	40	103	10	●
D918-A5N-0900	9.00	61	40	103	10	●
D918-A5N-0930	9.30	61	40	103	10	○
D918-A5N-0950	9.50	61	40	103	10	○
D918-A5N-0970	9.70	61	40	103	10	●
D918-A5N-0980	9.80	61	40	103	10	○
D918-A5N-1000	10.00	61	40	103	10	○
D918-A5N-1025	10.25	71	45	118	12	○

Ordering Code	D(m7)	Lc	L4	L	d(h6)	Stock
D918-A5N-1040	10.40	71	45	118	12	●
D918-A5N-1050	10.50	71	45	118	12	●
D918-A5N-1060	10.60	71	45	118	12	○
D918-A5N-1080	10.80	71	45	118	12	○
D918-A5N-1100	11.00	71	45	118	12	○
D918-A5N-1120	11.20	71	45	118	12	○
D918-A5N-1150	11.50	71	45	118	12	○
D918-A5N-1180	11.80	71	45	118	12	○
D918-A5N-1200	12.00	71	45	118	12	●
D918-A5N-1220	12.20	77	45	124	14	○
D918-A5N-1225	12.25	77	45	124	14	○
D918-A5N-1250	12.50	77	45	124	14	●
D918-A5N-1270	12.70	77	45	124	14	○
D918-A5N-1275	12.75	77	45	124	14	○
D918-A5N-1280	12.80	77	45	124	14	○

Accept non-standard custom from D2 to D20 tool.

● Stock ○ Available upon Order

Nominal Size Range	D(m7)	d(h6)
≥2-3	+0.002/+0.012	0.000/-0.006
>3-6	+0.004/+0.016	0.000/-0.008
>6-10	+0.006/+0.021	0.000/-0.009
>10-18	+0.007/+0.025	0.000/-0.011
>18-20	+0.008/+0.029	0.000/-0.013

Unit(mm)

Workpiece Material								
P			M	K			N	
1 2 3 4	5	6	1 2 3	1 2	3	1 2	3	4
Carbon Steels, Alloy Steels (<35HRC)	Alloy Steels, Tool Steels (35-48HRC)	PH and Ferrite/ Martensitic Stainless (<48HRC)	Stainless Steel	Grey Cast Iron, Nodular Cast Iron (<32HRC)	High Alloy Cast Iron (35-45HRC)	Wrought Aluminium Alloys, Cast Aluminium Alloys (Si≤12%)	Cast Aluminium Alloys (Si>12%)	Copper Alloys (<200HB)
○	○	○		○	○			

○ Most Suitable ○ Suitable

Recommended Cutting Data ※ P079

D918-A5N

5D External Cooling Twist Drills for General Purpose

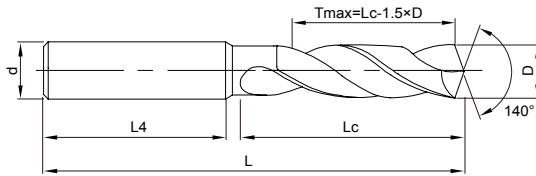

Tmax-Recommended Maximum Depth

» Continue

Ordering Code	D(m7)	Lc	L4	L	d(h6)	Stock
D918-A5N-1300	13.00	77	45	124	14	○
D918-A5N-1350	13.50	77	45	124	14	●
D918-A5N-1380	13.80	77	45	124	14	○
D918-A5N-1400	14.00	77	45	124	14	●
D918-A5N-1425	14.25	83	48	133	16	○
D918-A5N-1450	14.50	83	48	133	16	○
D918-A5N-1475	14.75	83	48	133	16	○
D918-A5N-1480	14.80	83	48	133	16	●
D918-A5N-1500	15.00	83	48	133	16	○
D918-A5N-1510	15.10	83	48	133	16	○
D918-A5N-1550	15.50	83	48	133	16	○
D918-A5N-1580	15.80	83	48	133	16	○
D918-A5N-1600	16.00	83	48	133	16	○

Ordering Code	D(m7)	Lc	L4	L	d(h6)	Stock
D918-A5N-1650	16.50	93	48	143	18	○
D918-A5N-1675	16.75	93	48	143	18	○
D918-A5N-1680	16.80	93	48	143	18	○
D918-A5N-1700	17.00	93	48	143	18	○
D918-A5N-1750	17.50	93	48	143	18	○
D918-A5N-1780	17.80	93	48	143	18	○
D918-A5N-1800	18.00	93	48	143	18	○
D918-A5N-1850	18.50	101	50	153	20	○
D918-A5N-1900	19.00	101	50	153	20	○
D918-A5N-1950	19.50	101	50	153	20	○
D918-A5N-1980	19.80	101	50	153	20	○
D918-A5N-2000	20.00	101	50	153	20	○

Note: Accept non-standard Customization from D2 to D20 tool.

● Stock ○ Available upon Order

Nominal Size Range	D(m7)	d(h6)
≥2-3	+0.002/+0.012	0.000/-0.006
>3-6	+0.004/+0.016	0.000/-0.008
>6-10	+0.006/+0.021	0.000/-0.009
>10-18	+0.007/+0.025	0.000/-0.011
>18-20	+0.008/+0.029	0.000/-0.013

Unit(mm)

Workpiece Material								
P			M	K			N	
1 2 3 4	5	6	1 2 3	1 2	3	1 2	3	4
Carbon Steels, Alloy Steels (<35HRC)	Alloy Steels, Tool Steels (35-48HRC)	PH and Ferrite/ Martensitic Stainless (<48HRC)	Stainless Steel	Grey Cast Iron, Nodular Cast Iron (<32HRC)	High Alloy Cast Iron (35-45HRC)	Wrought Aluminium Alloys, Cast Aluminium Alloys (Si≤12%)	Cast Aluminium Alloys (Si>12%)	Copper Alloys (<200HB)
○	○	○		○	○			

○ Most Suitable ○ Suitable

Recommended Cutting Data ※ P079

D918-A5C

5D Inner Cooling Twist Drills for General Purpose

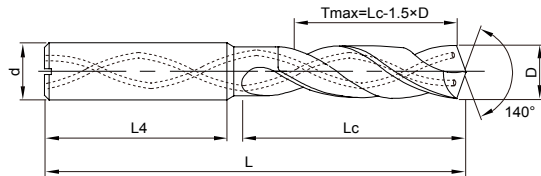

Tmax-Recommended Maximum Depth

Ordering Code	D(m7)	Lc	L4	L	d(h6)	Stock
D918-A5C-0500	5.00	44	36	82	6	○
D918-A5C-0510	5.10	44	36	82	6	○
D918-A5C-0520	5.20	44	36	82	6	○
D918-A5C-0550	5.50	44	36	82	6	○
D918-A5C-0555	5.55	44	36	82	6	○
D918-A5C-0580	5.80	44	36	82	6	○
D918-A5C-0600	6.00	44	36	82	6	○
D918-A5C-0610	6.10	53	36	91	8	○
D918-A5C-0620	6.20	53	36	91	8	○
D918-A5C-0630	6.30	53	36	91	8	○
D918-A5C-0650	6.50	53	36	91	8	○
D918-A5C-0660	6.60	53	36	91	8	○
D918-A5C-0680	6.80	53	36	91	8	○
D918-A5C-0690	6.90	53	36	91	8	○
D918-A5C-0700	7.00	53	36	91	8	○

Ordering Code	D(m7)	Lc	L4	L	d(h6)	Stock
D918-A5C-0710	7.10	53	36	91	8	○
D918-A5C-0740	7.40	53	36	91	8	○
D918-A5C-0750	7.50	53	36	91	8	○
D918-A5C-0780	7.80	53	36	91	8	○
D918-A5C-0800	8.00	53	36	91	8	○
D918-A5C-0810	8.10	61	40	103	10	○
D918-A5C-0840	8.40	61	40	103	10	○
D918-A5C-0850	8.50	61	40	103	10	○
D918-A5C-0860	8.60	61	40	103	10	○
D918-A5C-0870	8.70	61	40	103	10	●
D918-A5C-0880	8.80	61	40	103	10	●
D918-A5C-0900	9.00	61	40	103	10	○
D918-A5C-0930	9.30	61	40	103	10	●
D918-A5C-0950	9.50	61	40	103	10	○
D918-A5C-0960	9.60	61	40	103	10	○

Note: Accept non-standard custom from D3 to D20 tool.

● Stock ○ Available upon Order

Nominal Size Range	D(m7)	d(h6)
≥2-3	+0.002/+0.012	0.000/-0.006
>3-6	+0.004/+0.016	0.000/-0.008
>6-10	+0.006/+0.021	0.000/-0.009
>10-18	+0.007/+0.025	0.000/-0.011
>18-20	+0.008/+0.029	0.000/-0.013

Unit(mm)

Workpiece Material								
P			M	K		N		
1 2 3 4	5	6	1 2 3	1 2	3	1 2	3	4
Carbon Steels, Alloy Steels (<35HRC)	Alloy Steels, Tool Steels (35-48HRC)	PH and Ferrite/ Martensitic Stainless (<48HRC)	Stainless Steel	Grey Cast Iron, Nodular Cast Iron (<32HRC)	High Alloy Cast Iron (35-45HRC)	Wrought Aluminium Alloys, Cast Aluminium Alloys (Si≤12%)	Cast Aluminium Alloys (Si>12%)	Copper Alloys (<200HB)
○	○	○	○	○	○	○	○	○

○ Most Suitable ○ Suitable

Recommended Cutting Data ※ P079

D918-A5C

5D Inner Cooling Twist Drills for General Purpose

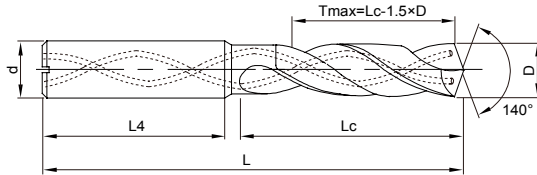

Tmax-Recommended Maximum Depth

» Continue

Ordering Code	D(m7)	Lc	L4	L	d(h6)	Stock
D918-A5C-0980	9.80	61	40	103	10	○
D918-A5C-1000	10.00	61	40	103	10	○
D918-A5C-1025	10.25	71	45	118	12	○
D918-A5C-1040	10.40	71	45	118	12	○
D918-A5C-1050	10.50	71	45	118	12	○
D918-A5C-1060	10.60	71	45	118	12	●
D918-A5C-1080	10.80	71	45	118	12	○
D918-A5C-1100	11.00	71	45	118	12	○
D918-A5C-1120	11.20	71	45	118	12	○
D918-A5C-1150	11.50	71	45	118	12	●
D918-A5C-1180	11.80	71	45	118	12	○
D918-A5C-1200	12.00	71	45	118	12	○
D918-A5C-1220	12.20	77	45	124	14	○
D918-A5C-1225	12.25	77	45	124	14	○
D918-A5C-1250	12.50	77	45	124	14	○

Ordering Code	D(m7)	Lc	L4	L	d(h6)	Stock
D918-A5C-1270	12.70	77	45	124	14	○
D918-A5C-1275	12.75	77	45	124	14	○
D918-A5C-1280	12.80	77	45	124	14	○
D918-A5C-1300	13.00	77	45	124	14	○
D918-A5C-1350	13.50	77	45	124	14	○
D918-A5C-1380	13.80	77	45	124	14	○
D918-A5C-1400	14.00	77	45	124	14	○
D918-A5C-1425	14.25	83	48	133	16	○
D918-A5C-1450	14.50	83	48	133	16	○
D918-A5C-1475	14.75	83	48	133	16	○
D918-A5C-1480	14.80	83	48	133	16	○
D918-A5C-1500	15.00	83	48	133	16	○
D918-A5C-1510	15.10	83	48	133	16	○
D918-A5C-1550	15.50	83	48	133	16	○
D918-A5C-1580	15.80	83	48	133	16	○
D918-A5C-1600	16.00	83	48	133	16	○

Note: Accept non-standard custom from D3 to D20 tool.

● Stock ○ Available upon Order

Nominal Size Range	D(m7)	d(h6)
≥2-3	+0.002/+0.012	0.000/-0.006
>3-6	+0.004/+0.016	0.000/-0.008
>6-10	+0.006/+0.021	0.000/-0.009
>10-18	+0.007/+0.025	0.000/-0.011
>18-20	+0.008/+0.029	0.000/-0.013

Unit(mm)

Workpiece Material								
P			M	K			N	
1 2 3 4	5	6	1 2 3	1 2	3	1 2	3	4
Carbon Steels, Alloy Steels (<35HRC)	Alloy Steels, Tool Steels (35-48HRC)	PH and Ferrite/ Martensitic Stainless (<48HRC)	Stainless Steel	Grey Cast Iron, Nodular Cast Iron (<32HRC)	High Alloy Cast Iron (35-45HRC)	Wrought Aluminium Alloys, Cast Aluminium Alloys (Si≤12%)	Cast Aluminium Alloys (Si>12%)	Copper Alloys (<200HB)
○	○	○	○	○	○	○	○	○

○ Most Suitable ○ Suitable

Recommended Cutting Data ※ P079

D928-A3N

3D External Cooling Twist Drills for Cast Iron

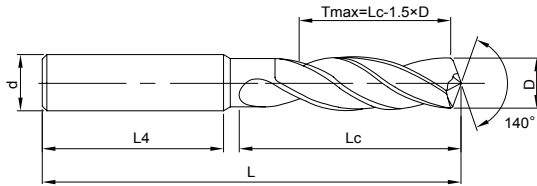

Tmax-Recommended Maximum Depth



Ordering Code	D(m7)	Lc	L4	L	d(h6)	Stock
D928-A3N-0300	3.00	20	36	62	6	○
D928-A3N-0330	3.30	20	36	62	6	○
D928-A3N-0400	4.00	24	36	66	6	○
D928-A3N-0420	4.20	24	36	66	6	○
D928-A3N-0500	5.00	28	36	66	6	○
D928-A3N-0600	6.00	28	36	66	6	○
D928-A3N-0680	6.80	34	36	79	8	○
D928-A3N-0700	7.00	34	36	79	8	○
D928-A3N-0800	8.00	41	36	79	8	○
D928-A3N-0850	8.50	47	40	89	10	○
D928-A3N-0900	9.00	47	40	89	10	○
D928-A3N-1000	10.00	47	40	89	10	○
D928-A3N-1025	10.25	55	45	102	12	○

Ordering Code	D(m7)	Lc	L4	L	d(h6)	Stock
D928-A3N-1050	10.50	55	45	102	12	○
D928-A3N-1100	11.00	55	45	102	12	○
D928-A3N-1200	12.00	55	45	102	12	○
D928-A3N-1250	12.50	60	45	107	14	○
D928-A3N-1300	13.00	60	45	107	14	○
D928-A3N-1400	14.00	60	45	107	14	○
D928-A3N-1450	14.50	65	48	115	16	○
D928-A3N-1500	15.00	65	48	115	16	○
D928-A3N-1600	16.00	65	48	115	16	○
D928-A3N-1700	17.00	73	48	123	18	○
D928-A3N-1800	18.00	73	48	123	18	○
D928-A3N-1900	19.00	79	50	131	20	○
D928-A3N-2000	20.00	79	50	131	20	○

Note: Accept non-standard custom from D2 to D20 tool.

● Stock ○ Available upon Order

Nominal Size Range	D(m7)	d(h6)
≥2-3	+0.002/+0.012	0.000/-0.006
>3-6	+0.004/+0.016	0.000/-0.008
>6-10	+0.006/+0.021	0.000/-0.009
>10-18	+0.007/+0.025	0.000/-0.011
>18-20	+0.008/+0.029	0.000/-0.013

Unit(mm)

Workpiece Material								
P			M	K			N	
1 2 3 4	5	6	1 2 3	1 2	3	1 2	3	4
Carbon Steels, Alloy Steels (<35HRC)	Alloy Steels, Tool Steels (35-48HRC)	PH and Ferrite/ Martensitic Stainless (<48HRC)	Stainless Steel	Grey Cast Iron, Nodular Cast Iron (<32HRC)	High Alloy Cast Iron (35-45HRC)	Wrought Aluminium Alloys, Cast Aluminium Alloys (Si≤12%)	Cast Aluminium Alloys (Si>12%)	Copper Alloys (<200HB)
○				○	○			

○ Most Suitable ○ Suitable

Recommended Cutting Data ※ P081

D928-A3C

3D Inner Cooling Twist Drills for Cast Iron

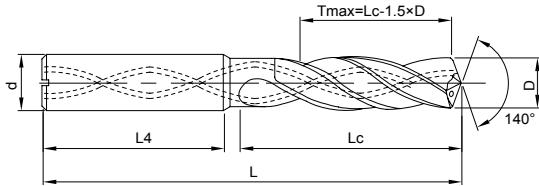

T_{max}-Recommended Maximum Depth

Ordering Code	D(m7)	Lc	L4	L	d(h6)	Stock
D928-A3C-0500	5.00	28	36	66	6	○
D928-A3C-0600	6.00	28	36	66	6	○
D928-A3C-0680	6.80	34	36	79	8	○
D928-A3C-0700	7.00	34	36	79	8	○
D928-A3C-0800	8.00	41	36	79	8	○
D928-A3C-0850	8.50	47	40	89	10	○
D928-A3C-0900	9.00	47	40	89	10	○
D928-A3C-1000	10.00	47	40	89	10	○
D928-A3C-1025	10.25	55	45	102	12	○
D928-A3C-1050	10.50	55	45	102	12	○
D928-A3C-1100	11.00	55	45	102	12	○

Ordering Code	D(m7)	Lc	L4	L	d(h6)	Stock
D928-A3C-1200	12.00	55	45	102	12	○
D928-A3C-1250	12.50	60	45	107	14	○
D928-A3C-1300	13.00	60	45	107	14	○
D928-A3C-1400	14.00	60	45	107	14	○
D928-A3C-1450	14.50	65	48	115	16	○
D928-A3C-1500	15.00	65	48	115	16	○
D928-A3C-1600	16.00	65	48	115	16	○
D928-A3C-1700	17.00	73	48	123	18	○
D928-A3C-1800	18.00	73	48	123	18	○
D928-A3C-1900	19.00	79	50	131	20	○
D928-A3C-2000	20.00	79	50	131	20	○

Note: Accept non-standard custom from D3 to D20 tool.

● Stock ○ Available upon Order

Nominal Size Range	D(m7)	d(h6)
≥2-3	+0.002/+0.012	0.000/-0.006
>3-6	+0.004/+0.016	0.000/-0.008
>6-10	+0.006/+0.021	0.000/-0.009
>10-18	+0.007/+0.025	0.000/-0.011
>18-20	+0.008/+0.029	0.000/-0.013

Unit(mm)

Workpiece Material								
P			M	K			N	
1 2 3 4	5	6	1 2 3	1 2	3	1 2	3	4
Carbon Steels, Alloy Steels (<35HRC)	Alloy Steels, Tool Steels (35-48HRC)	PH and Ferrite/ Martensitic Stainless (<48HRC)	Stainless Steel	Grey Cast Iron, Nodular Cast Iron (<32HRC)	High Alloy Cast Iron (35-45HRC)	Wrought Aluminium Alloys, Cast Aluminium Alloys (Si≤12%)	Cast Aluminium Alloys (Si>12%)	Copper Alloys (<200HB)
○				○	○	○	○	

○ Most Suitable ○ Suitable

Recommended Cutting Data ※ P081

D928-A5N

5D External Cooling Twist Drills for Cast Iron

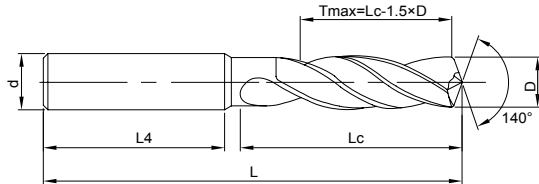

Tmax-Recommended Maximum Depth



Ordering Code	D(m7)	Lc	L4	L	d(h6)	Stock
D928-A5N-0300	3.00	28	36	66	6	○
D928-A5N-0330	3.30	28	36	66	6	○
D928-A5N-0400	4.00	36	36	74	6	○
D928-A5N-0420	4.20	36	36	74	6	○
D928-A5N-0500	5.00	44	36	82	6	○
D928-A5N-0600	6.00	44	36	82	6	○
D928-A5N-0680	6.80	53	36	91	8	○
D928-A5N-0700	7.00	53	36	91	8	○
D928-A5N-0800	8.00	53	36	91	8	○
D928-A5N-0850	8.50	61	40	103	10	○
D928-A5N-0900	9.00	61	40	103	10	○
D928-A5N-1000	10.00	61	40	103	10	○
D928-A5N-1025	10.25	71	45	118	12	○

Ordering Code	D(m7)	Lc	L4	L	d(h6)	Stock
D928-A5N-1050	10.50	71	45	118	12	○
D928-A5N-1100	11.00	71	45	118	12	○
D928-A5N-1200	12.00	71	45	118	12	○
D928-A5N-1250	12.50	77	45	124	14	○
D928-A5N-1300	13.00	77	45	124	14	○
D928-A5N-1400	14.00	77	45	124	14	○
D928-A5N-1450	14.50	83	48	133	16	○
D928-A5N-1500	15.00	83	48	133	16	○
D928-A5N-1600	16.00	83	48	133	16	○
D928-A5N-1700	17.00	93	48	143	18	○
D928-A5N-1800	18.00	93	48	143	18	○
D928-A5N-1900	19.00	101	50	153	20	○
D928-A5N-2000	20.00	101	50	153	20	○

Note: Accept non-standard custom from D2 to D20 tool.

● Stock ○ Available upon Order

Nominal Size Range	D(m7)	d(h6)
≥2-3	+0.002/+0.012	0.000/-0.006
>3-6	+0.004/+0.016	0.000/-0.008
>6-10	+0.006/+0.021	0.000/-0.009
>10-18	+0.007/+0.025	0.000/-0.011
>18-20	+0.008/+0.029	0.000/-0.013

Unit(mm)

Workpiece Material								
P			M	K		N		
1 2 3 4	5	6	1 2 3	1 2	3	1 2	3	4
Carbon Steels, Alloy Steels (<35HRC)	Alloy Steels, Tool Steels (35-48HRC)	PH and Ferrite/ Martensitic Stainless (<48HRC)	Stainless Steel	Grey Cast Iron, Nodular Cast Iron (<32HRC)	High Alloy Cast Iron (35-45HRC)	Wrought Aluminium Alloys, Cast Aluminium Alloys (Si≤12%)	Cast Aluminium Alloys (Si>12%)	Copper Alloys (<200HB)
○				○	○			

○ Most Suitable ○ Suitable

Recommended Cutting Data ※ P081

D928-A5C

5D Inner Cooling Twist Drills for Cast Iron

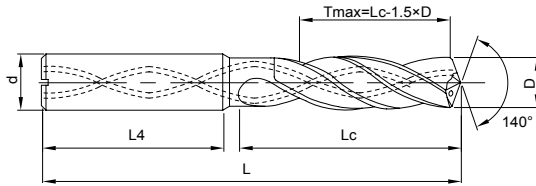

Tmax-Recommended Maximum Depth

Ordering Code	D(m7)	Lc	L4	L	d(h6)	Stock
D928-A5C-0500	5.00	44	36	82	6	○
D928-A5C-0600	6.00	44	36	82	6	○
D928-A5C-0680	6.80	53	36	91	8	○
D928-A5C-0700	7.00	53	36	91	8	○
D928-A5C-0800	8.00	53	36	91	8	○
D928-A5C-0850	8.50	61	40	103	10	○
D928-A5C-0900	9.00	61	40	103	10	○
D928-A5C-1000	10.00	61	40	103	10	○
D928-A5C-1025	10.25	71	45	118	12	○
D928-A5C-1050	10.50	71	45	118	12	○
D928-A5C-1100	11.00	71	45	118	12	○

Ordering Code	D(m7)	Lc	L4	L	d(h6)	Stock
D928-A5C-1200	12.00	71	45	118	12	○
D928-A5C-1250	12.50	77	45	124	14	○
D928-A5C-1300	13.00	77	45	124	14	○
D928-A5C-1400	14.00	77	45	124	14	○
D928-A5C-1450	14.50	83	48	133	16	○
D928-A5C-1500	15.00	83	48	133	16	○
D928-A5C-1600	16.00	83	48	133	16	○
D928-A5C-1700	17.00	93	48	143	18	○
D928-A5C-1800	18.00	93	48	143	18	○
D928-A5C-1900	19.00	101	50	153	20	○
D928-A5C-2000	20.00	101	50	153	20	○

Note: Accept non-standard custom from D2 to D20 tool.

● Stock ○ Available upon Order

Nominal Size Range	D(m7)	d(h6)
≥2-3	+0.002/+0.012	0.000/-0.006
>3-6	+0.004/+0.016	0.000/-0.008
>6-10	+0.006/+0.021	0.000/-0.009
>10-18	+0.007/+0.025	0.000/-0.011
>18-20	+0.008/+0.029	0.000/-0.013

Unit(mm)

Workpiece Material								
P			M	K			N	
1	2	3	4	5	6	7	8	9
Carbon Steels, Alloy Steels (<35HRC)	Alloy Steels, Tool Steels (35-48HRC)	PH and Ferrite/ Martensitic Stainless (<48HRC)	Stainless Steel	Grey Cast Iron, Nodular Cast Iron (<32HRC)	High Alloy Cast Iron (35-45HRC)	Wrought Aluminium Alloys, Cast Aluminium Alloys (Si≤12%)	Cast Aluminium Alloys (Si>12%)	Copper Alloys (<200HB)
○				○	○	○	○	

○ Most Suitable ○ Suitable

Recommended Cutting Data ※ P081

D998-Y3N

3D External Cooling Twist Drills for Hardened Steel

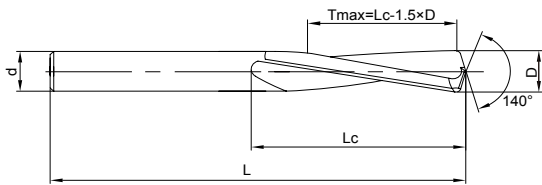

Tmax-Recommended Maximum Depth



Ordering Code	D(h7)	Lc	L	d(h6)	Stock
D998-Y3N-0400	4.0	22	55	4	○
D998-Y3N-0500	5.0	26	62	5	○
D998-Y3N-0600	6.0	28	66	6	○
D998-Y3N-0700	7.0	34	74	7	○
D998-Y3N-0800	8.0	37	79	8	○
D998-Y3N-0900	9.0	40	84	9	○
D998-Y3N-1000	10.0	43	89	10	○

Ordering Code	D(h7)	Lc	L	d(h6)	Stock
D998-Y3N-1100	11.0	47	95	11	○
D998-Y3N-1200	12.0	51	102	12	○
D998-Y3N-1300	13.0	51	102	13	○
D998-Y3N-1400	14.0	54	107	14	○
D998-Y3N-1500	15.0	56	111	15	○
D998-Y3N-1600	16.0	58	115	16	○

Note: Accept non-standard custom from D2 to D20 tool.

● Stock ○ Available upon Order

Nominal Size Range	D(h7)	d(h6)
≥2-3	0.000/-0.010	0.000/-0.006
>3-6	0.000/-0.012	0.000/-0.008
>6-10	0.000/-0.015	0.000/-0.009
>10-18	0.000/-0.018	0.000/-0.011
>18-20	0.000/-0.021	0.000/-0.013

Unit(mm)

Workpiece Material							
P			M	K		H	
1 2 3 4	5	6	1 2 3	1 2	3	1	2
Carbon Steels, Alloy Steels (<35HRC)	Alloy Steels, Tool Steels (35-48HRC)	PH and Ferrite/ Martensitic Stainless (<48HRC)	Stainless Steel	Grey Cast Iron, Nodular Cast Iron (<32HRC)	High Alloy Cast Iron (35-45HRC)	Hardened Steels (45-55HRC)	Hardened Steels (55-60HRC)
						◎	○

◎ Most Suitable ○ Suitable

Recommended Cutting Data ※ P083

D713-A5N

5D External Cooling Straight Fluted Drills for Cast Iron

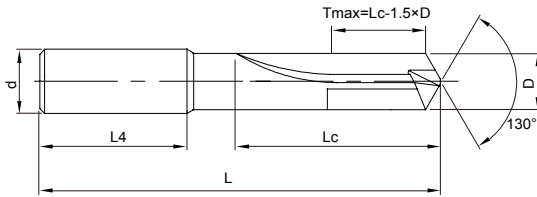

Tmax-Recommended Maximum Depth

Ordering Code	D(k6)	Lc	L4	L	d(h6)	Stock
D713-A5N-0400	4.00	36	36	74	6	○
D713-A5N-0420	4.20	36	36	74	6	○
D713-A5N-0500	5.00	44	36	82	6	○
D713-A5N-0600	6.00	44	36	82	6	○
D713-A5N-0680	6.80	53	36	91	8	○
D713-A5N-0700	7.00	53	36	91	8	○
D713-A5N-0800	8.00	53	36	91	8	○
D713-A5N-0850	8.50	61	40	103	10	○
D713-A5N-0900	9.00	61	40	103	10	○
D713-A5N-1000	10.00	61	40	103	10	○
D713-A5N-1025	10.25	71	45	118	12	○
D713-A5N-1100	11.00	71	45	118	12	○

Ordering Code	D(k6)	Lc	L4	L	d(h6)	Stock
D713-A5N-1200	12.00	71	45	118	12	○
D713-A5N-1300	13.00	77	45	124	14	○
D713-A5N-1400	14.00	77	45	124	14	○
D713-A5N-1500	15.00	83	48	133	16	○
D713-A5N-1550	15.50	83	48	133	16	○
D713-A5N-1600	16.00	83	48	133	16	○
D713-A5N-1700	17.00	93	48	143	18	○
D713-A5N-1750	17.50	93	48	143	18	○
D713-A5N-1800	18.00	93	48	143	18	○
D713-A5N-1950	19.50	101	50	153	20	○
D713-A5N-2000	20.00	101	50	153	20	○

Nominal Size Range	D(k6)	d(h6)
≥2-3	+0.006/+0.000	0.000/-0.006
>3-6	+0.009/+0.001	0.000/-0.008
>6-10	+0.010/+0.001	0.000/-0.009
>10-18	+0.012/+0.001	0.000/-0.011
>18-20	+0.015/+0.002	0.000/-0.013

Unit(mm)

Note: Accept non-standard custom from D2 to D20 tool.

● Stock ○ Available upon Order

Workpiece Material								
P			M	K			N	
1	2	3	4	5	6	7	8	9
Carbon Steels, Alloy Steels (<35HRC)	Alloy Steels, Tool Steels (35-48HRC)	PH and Ferrite/ Martensitic Stainless (<48HRC)	Stainless Steel	Grey Cast Iron, Nodular Cast Iron (<32HRC)	High Alloy Cast Iron (35-45HRC)	Wrought Aluminium Alloys, Cast Aluminium Alloys (Si≤12%)	Cast Aluminium Alloys (Si>12%)	Copper Alloys (<200HB)
				○	○		○	

○ Most Suitable ○ Suitable

Recommended Cutting Data ※ P084

D713-A5C

5D Inner Cooling Straight Fluted Drills for Cast Iron

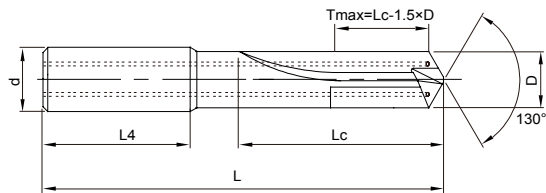

T_{max}-Recommended Maximum Depth



Ordering Code	D(k6)	Lc	L4	L	d(h6)	Stock
D713-A5C-0400	4.00	36	36	74	6	○
D713-A5C-0420	4.20	36	36	74	6	○
D713-A5C-0500	5.00	44	36	82	6	○
D713-A5C-0600	6.00	44	36	82	6	○
D713-A5C-0680	6.80	53	36	91	8	○
D713-A5C-0700	7.00	53	36	91	8	○
D713-A5C-0800	8.00	53	36	91	8	○
D713-A5C-0850	8.50	61	40	103	10	○
D713-A5C-0900	9.00	61	40	103	10	○
D713-A5C-1000	10.00	61	40	103	10	○
D713-A5C-1025	10.25	71	45	118	12	○
D713-A5C-1100	11.00	71	45	118	12	○

Ordering Code	D(k6)	Lc	L4	L	d(h6)	Stock
D713-A5C-1200	12.00	71	45	118	12	○
D713-A5C-1300	13.00	77	45	124	14	○
D713-A5C-1400	14.00	77	45	124	14	○
D713-A5C-1500	15.00	83	48	133	16	○
D713-A5C-1550	15.50	83	48	133	16	○
D713-A5C-1600	16.00	83	48	133	16	○
D713-A5C-1700	17.00	93	48	143	18	○
D713-A5C-1750	17.50	93	48	143	18	○
D713-A5C-1800	18.00	93	48	143	18	○
D713-A5C-1950	19.50	101	50	153	20	○
D713-A5C-2000	20.00	101	50	153	20	○

Note: Accept non-standard custom from D3 to D20 tool.

● Stock ○ Available upon Order

Nominal Size Range	D(k6)	d(h6)
≥2-3	+0.006/+0.000	0.000/-0.006
>3-6	+0.009/+0.001	0.000/-0.008
>6-10	+0.010/+0.001	0.000/-0.009
>10-18	+0.012/+0.001	0.000/-0.011
>18-20	+0.015/+0.002	0.000/-0.013

Unit(mm)

Workpiece Material								
P			M	K			N	
1 2 3 4	5	6	1 2 3	1 2	3	1 2	3	4
Carbon Steels, Alloy Steels (<35HRC)	Alloy Steels, Tool Steels (35-48HRC)	PH and Ferrite/ Martensitic Stainless (<48HRC)	Stainless Steel	Grey Cast Iron, Nodular Cast Iron (<32HRC)	High Alloy Cast Iron (35-45HRC)	Wrought Aluminium Alloys, Cast Aluminium Alloys (Si≤12%)	Cast Aluminium Alloys (Si>12%)	Copper Alloys (<200HB)
				○	○		○	

○ Most Suitable ○ Suitable

Recommended Cutting Data ※ P084

D101-AMN

90°NC Centre Drills

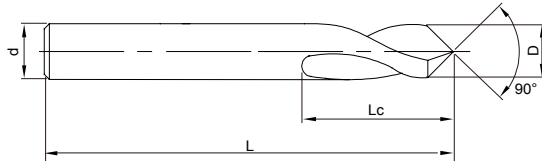

Tmax-Recommended Maximum Depth

Ordering Code	D	Lc	L	d(h6)	Stock
D101-AMN-0500	5.00	10	62	5	●
D101-AMN-0600	6.00	15	66	6	●
D101-AMN-0800	8.00	17	79	8	●
D101-AMN-1000	10.00	20	89	10	●
D101-AMN-1200	12.00	25	102	12	●
D101-AMN-1400	14.00	30	107	14	●
D101-AMN-1600	16.00	35	115	16	●
D101-AMN-2000	20.00	40	131	20	●

Note: Accept non-standard custom from D2 to D20 tool.

Unit(mm)

● Stock ○ Available upon Order

Workpiece Material								
P			M	K			N	
1 2 3 4	5	6	1 2 3	1 2	3	1 2	3	4
Carbon Steels, Alloy Steels (<35HRC)	Alloy Steels, Tool Steels (35-48HRC)	PH and Ferrite/ Martensitic Stainless (<48HRC)	Stainless Steel	Grey Cast Iron, Nodular Cast Iron (<32HRC)	High Alloy Cast Iron (35-45HRC)	Wrought Aluminium Alloys, Cast Aluminium Alloys (Si≤12%)	Cast Aluminium Alloys (Si>12%)	Copper Alloys (<200HB)
○	○	○		○		○	○	○

○ Most Suitable ○ Suitable

Recommended Cutting Data ※ P078

D102-ANN

120°NC Centre Drills

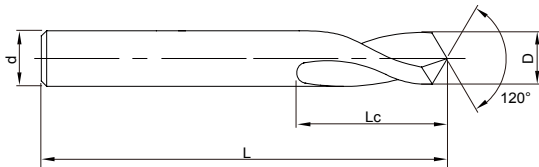

Ordering Code	D	Lc	L	d(h6)	Stock
D102-ANN-0500	5.00	10	62	5	○
D102-ANN-0600	6.00	15	66	6	○
D102-ANN-0800	8.00	17	79	8	○
D102-ANN-1000	10.00	20	89	10	○
D102-ANN-1200	12.00	25	102	12	○
D102-ANN-1400	14.00	30	107	14	○
D102-ANN-1600	16.00	35	115	16	○
D102-ANN-2000	20.00	40	131	20	○

Note: Accept non-standard custom from D2 to D20 tool.

Unit(mm)

● Stock ○ Available upon Order

Workpiece Material												
P			M	K			N					
1	2	3	4	5	6	1	2	3	1	2	3	4
Carbon Steels, Alloy Steels (<35HRC)	Alloy Steels, Tool Steels (35-48HRC)	PH and Ferrite/ Martensitic Stainless (<48HRC)	Stainless Steel	Grey Cast Iron, Nodular Cast Iron (<32HRC)	High Alloy Cast Iron (35-45HRC)	Wrought Aluminium Alloys, Cast Aluminium Alloys (Si≤12%)	Cast Aluminium Alloys (Si>12%)	Copper Alloys (<200HB)				
○	○	○			○	○	○	○				

○ Most Suitable ○ Suitable

Recommended Cutting Data ※ P078

D103-APN

145°NC Centre Drills

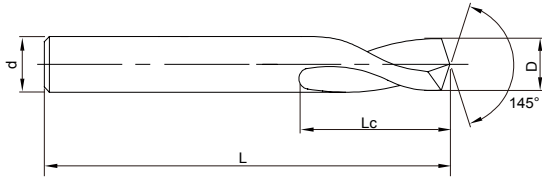

Ordering Code	D	Lc	L	d(h6)	Stock
D103-APN-0500	5.00	10	62	5	○
D103-APN-0600	6.00	15	66	6	○
D103-APN-0800	8.00	17	79	8	○
D103-APN-1000	10.00	20	89	10	○
D103-APN-1200	12.00	25	102	12	○
D103-APN-1400	14.00	30	107	14	○
D103-APN-1600	16.00	35	115	16	○
D103-APN-2000	20.00	40	131	20	○

Note: Accept non-standard custom from D2 to D20 tool.

Unit(mm)

● Stock ○ Available upon Order

Workpiece Material									
P			M	K			N		
1	2	3	4	5	6	1	2	3	4
Carbon Steels, Alloy Steels (<35HRC)	Alloy Steels, Tool Steels (35-48HRC)	PH and Ferrite/ Martensitic Stainless (<48HRC)	Stainless Steel	Grey Cast Iron, Nodular Cast Iron (<32HRC)	High Alloy Cast Iron (35-45HRC)	Wrought Aluminium Alloys, Cast Aluminium Alloys (Si≤12%)	Cast Aluminium Alloys (Si>12%)	Copper Alloys (<200HB)	
○	○	○		○		○	○	○	○

○ Most Suitable ○ Suitable

Recommended Cutting Data ※ P078

D612-Y3N

Triple-angle Drills for Composite Material

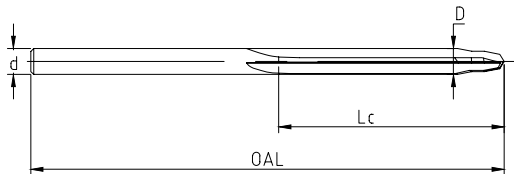

Ordering Code	D(mm)	D(in)	Lc	OAL	d	Linumber /Diameter (in)	Stock
D612-Y3N-0249	2.49	0.0980	15	60	2.49	—	○
D612-Y3N-0270	2.70	0.1063	15	60	2.70	—	○
D612-Y3N-0300	3.00	0.1181	18	60	3.00	—	○
D612-Y3N-0320	3.20	0.1260	20	75	3.20	—	○
D612-Y3N-0326	3.26	0.1283	20	75	3.26	30#	○
D612-Y3N-0400	4.00	0.1575	30	75	4.00	—	○
D612-Y3N-0409	4.09	0.1610	30	75	4.09	20#	○
D612-Y3N-0450	4.50	0.1772	30	75	4.50	16#	○
D612-Y3N-0480	4.80	0.1890	30	75	4.80	12#	○

Ordering Code	D(mm)	D(in)	Lc	OAL	d	Linumber /Diameter (in)	Stock
D612-Y3N-04826	4.826	0.1900	30	75	4.83	—	○
D612-Y3N-0491	4.91	0.1933	30	75	4.91	10#	○
D612-Y3N-0500	5.00	0.1969	35	100	5.00	—	○
D612-Y3N-0505	5.05	0.1988	35	100	5.05	8#	○
D612-Y3N-0522	5.22	0.2055	35	100	5.22	5#	○
D612-Y3N-0600	6.00	0.2362	40	100	6.00	—	○
D612-Y3N-0635	6.35	0.2500	40	100	6.35	—	○
D612-Y3N-0794	7.94	0.3126	40	100	7.94	—	○

Unit(mm)

Note: Accept non-standard custom from D1.5 to D16 tool.

● Stock ○ Available upon Order

Workpiece Material									
P			M	K			N		
1 2 3 4	5	6	1 2 3	1 2	3	1 2	3	4	5
Carbon Steels, Alloy Steels (<35HRC)	Alloy Steels, Tool Steels (35-48HRC)	PH and Ferrite/ Martensitic Stainless (<48HRC)	Stainless Steel	Grey Cast Iron, Nodular Cast Iron (<32HRC)	High Alloy Cast Iron (35-45HRC)	Wrought Aluminium Alloys, Cast Aluminium Alloys (Si≤12%)	Cast Aluminium Alloys (Si>12%)	Copper Alloys (<200HB)	Composite Material
									○

○ Most Suitable ○ Suitable

Recommended Cutting Data ※ P085

D973-Y5N

Twist Drills for Composite and Metal

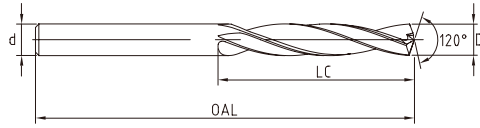

Ordering Code	D(mm)	D(in)	Lc	OAL	d	Linenumber / Diameter (in)	Stock
D973-Y5N-0250	2.50	0.0984	25	75	2.50	—	○
D973-Y5N-0270	2.70	0.1063	25	75	2.70	—	○
D973-Y5N-0300	3.00	0.1181	25	75	3.00	—	○
D973-Y5N-0310	3.10	0.1220	25	75	3.10	—	○
D973-Y5N-0326	3.26	0.1285	35	75	3.26	30#	○
D973-Y5N-0400	4.00	0.1575	35	100	4.00	—	○
D973-Y5N-0409	4.09	0.1610	40	100	4.09	20#	○
D973-Y5N-0417	4.17	0.1640	40	100	4.17	—	○
D973-Y5N-0470	4.70	0.1850	40	100	4.70	13#	○
D973-Y5N-0483	4.83	0.1900	40	100	4.83	—	○
D973-Y5N-0500	5.00	0.1969	40	100	5.00	—	○
D973-Y5N-0556	5.56	0.2190	40	100	5.56	—	○
D973-Y5N-0595	5.95	0.2344	40	100	5.95	15/64	○
D973-Y5N-0600	6.00	0.2362	40	100	6.00	—	○
D973-Y5N-0635	6.35	0.2500	40	100	6.35	1/4	○
D973-Y5N-0750	7.50	0.2953	45	120	7.50	—	○
D973-Y5N-0794	7.94	0.3125	45	120	7.94	5/16	○

Note: Accept non-standard custom from D2 to D16 tool.

Unit(mm)

● Stock ○ Available upon Order

Workpiece Material								
P			M	N			S	
1 2 3 4	5	6	1 2 3	1 2	3	4	5	1 2 3 4
Carbon Steels, Alloy Steels (<35HRC)	Alloy Steels, Tool Steels (35-48HRC)	PH and Ferrite/ Martensitic Stainless (<48HRC)	Stainless Steel	Wrought Aluminium Alloys, Cast Aluminium Alloys (Si≤12%)	Cast Aluminium Alloys (Si>12%)	Copper Alloys (<200HB)	Composite Material	Titanium alloy, Heat-resistant Super Alloys
○	○		◎	◎	◎		○	◎

◎ Most Suitable ○ Suitable

Recommended Cutting Data ※ P085

D573-Y3N

Core Drills for Composite and Metal

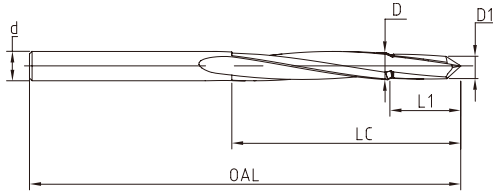

Ordering Code	D(mm)	D(in)	D1	L1	Lc	d	OAL	Linenumber / Diameter (in)	Stock
D573-Y3N-0400	4.00	0.157	3.26	8.0	40.0	4.00	80	—	○
D573-Y3N-0409	4.09	0.161	3.37	8.0	40.0	4.09	80	20#	○
D573-Y3N-0417	4.17	0.164	3.37	8.0	40.0	4.17	80	—	○
D573-Y3N-0437	4.37	0.172	4.10	8.0	40.0	4.37	80	17#	○
D573-Y3N-0450	4.50	0.177	4.10	8.0	40.0	4.50	100	—	○
D573-Y3N-0470	4.70	0.185	4.17	8.0	40.0	4.70	100	13#	○
D573-Y3N-0485	4.85	0.191	4.37	8.0	40.0	4.85	100	11#	○
D573-Y3N-0500	5.00	0.197	4.37	10.0	50.0	5.00	100	—	○
D573-Y3N-0518	5.18	0.204	4.85	10.0	50.0	5.18	100	6#	○
D573-Y3N-0556	5.56	0.219	4.70	10.0	50.0	5.56	100	—	○
D573-Y3N-0595	5.95	0.234	5.56	10.0	50.0	5.95	100	—	○
D573-Y3N-0625	6.25	0.246	5.95	10.0	50.0	6.25	100	—	○
D573-Y3N-0754	7.54	0.297	6.35	10.0	50.0	7.54	100	—	○
D573-Y3N-0767	7.67	0.302	6.35	10.0	50.0	7.67	120	—	○
D573-Y3N-0930	9.30	0.366	8.40	10.0	50.0	9.30	120	—	○

Note: Accept non-standard custom from D3 to D16 tool.

Unit(mm)

● Stock ○ Available upon Order



Workpiece Material									
P			M	N			S		
1 2 3 4	5	6	1 2 3	1 2	3	4	5	1 2 3 4	
Carbon Steels, Alloy Steels (<35HRC)	Alloy Steels, Tool Steels (35-48HRC)	PH and Ferrite/ Martensitic Stainless (<48HRC)	Stainless Steel	Wrought Aluminium Alloys, Cast Aluminium Alloys (Si≤12%)	Cast Aluminium Alloys (Si>12%)	Copper Alloys (<200HB)	Composite Material	Titanium alloy, Heat-resistant Super Alloys	
○	○		○	○	○		○	○	

○ Most Suitable ○ Suitable

Recommended Cutting Data ※ P085

Recommended Cutting Data

D918S High Performance Twist Drills for Steel



Workpiece		Vc (m/min)		fn (mm/rev)				
				Φ3	Φ4	Φ6	Φ8	Φ10
P	Low-carbon Steels, Long Chipping (<125HB)	100-80-50	140-100-60	0.09-0.13-0.16	0.11-0.15-0.19	0.14-0.19-0.23	0.19-0.25-0.31	0.23-0.30-0.38
	Low-carbon Steels, Short Chipping, Free-cutting Steels (<125HB)	100-75-50	140-100-60	0.09-0.13-0.16	0.11-0.15-0.19	0.14-0.19-0.23	0.19-0.25-0.31	0.23-0.30-0.38
	High-carbon Steels, Medium-carbon Steels (<25HRC)	90-70-45	120-80-60	0.09-0.13-0.16	0.11-0.15-0.19	0.14-0.19-0.23	0.19-0.25-0.31	0.23-0.30-0.38
	Alloy Steels, Tool Steels. (<35HRC)	90-70-45	110-80-50	0.09-0.13-0.16	0.11-0.15-0.19	0.14-0.19-0.23	0.19-0.25-0.31	0.23-0.30-0.38
	Alloy Steels, Tool Steels. (35-48HRC)	80-60-40	90-60-40	0.09-0.12-0.14	0.10-0.14-0.17	0.13-0.17-0.22	0.17-0.23-0.29	0.21-0.28-0.35
M	Austenitic Stainless Steels (130-200HB)	40-30-20	80-60-40	0.05-0.08-0.10	0.06-0.10-0.12	0.07-0.12-0.14	0.08-0.13-0.18	0.09-0.15-0.20
	High-Strength Austenitic Stainless Steels and Cast Stainless Steels (<25HRC)	40-30-20	80-60-40	0.03-0.06-0.08	0.04-0.08-0.10	0.05-0.08-0.10	0.06-0.10-0.12	0.07-0.11-0.14
	Duplex Stainless Steels (<30HRC)	35-25-20	60-45-30	0.03-0.06-0.08	0.04-0.08-0.10	0.05-0.08-0.10	0.06-0.10-0.12	0.07-0.11-0.14
K	Grey Cast Iron (<32HRC)	100-80-60	140-120-60	0.13-0.17-0.20	0.15-0.20-0.23	0.17-0.25-0.30	0.20-0.27-0.35	0.23-0.30-0.40
	Moderately Difficult Alloy Cast iron, Nodular Cast Iron (<28HRC)	100-80-60	140-120-60	0.11-0.15-0.18	0.13-0.17-0.20	0.15-0.20-0.25	0.17-0.25-0.32	0.20-0.28-0.36
	Difficult High-alloy Cast Iron, Nodular Cast Iron (<45HRC)	90-70-60	100-90-60	0.06-0.09-0.11	0.08-0.10-0.13	0.10-0.13-0.16	0.12-0.16-0.20	0.14-0.20-0.26

Remark:

1. Make sure work piece and machine are stable and use a precision holder, use hydraulic chucks, high quality collet chucks.
2. Make sure total indicated run-out (TIR) is less than 0.02mm.
3. The recommended cutting condition is suitable for apply water soluble.
4. If the tool size is not in the table, please refer to the table closest to the blade diameter size selection of cutting parameters, adjust cutting parameters according to actual working conditions during processing.

Recommended Cutting Data

D918S High Performance Twist Drills for Steel



Workpiece		Vc (m/min)		fn (mm/rev)				
				Φ12	Φ14	Φ16	Φ18	Φ20
P	Low-carbon Steels, Long Chipping (<125HB)	100-80-50	140-100-60	0.24-0.33-0.41	0.28-0.38-0.45	0.30-0.42-0.50	0.33-0.42-0.50	0.34-0.43-0.51
	Low-carbon Steels, Short Chipping, Free-cutting Steels (<125HB)	100-75-50	140-100-60	0.24-0.33-0.41	0.28-0.38-0.45	0.30-0.42-0.50	0.33-0.42-0.50	0.34-0.43-0.51
	High-carbon Steels, Medium-carbon Steels (<25HRC)	90-70-45	120-80-60	0.24-0.33-0.41	0.28-0.38-0.45	0.30-0.42-0.50	0.33-0.42-0.50	0.34-0.43-0.51
	Alloy Steels, Tool Steels. (<35HRC)	90-70-45	110-80-50	0.24-0.33-0.41	0.28-0.38-0.45	0.30-0.42-0.50	0.33-0.42-0.50	0.34-0.43-0.51
	Alloy Steels, Tool Steels. (35-48HRC)	80-60-40	90-60-40	0.22-0.30-0.37	0.26-0.35-0.41	0.28-0.37-0.44	0.31-0.38-0.46	0.31-0.39-0.47
M	Austenitic Stainless Steels (130-200HB)	40-30-20	80-60-40	0.10-0.17-0.22	0.11-0.18-0.24	0.12-0.20-0.24	0.13-0.22-0.26	0.14-0.24-0.28
	High-Strength Austenitic Stainless Steels and Cast Stainless Steels (<25HRC)	40-30-20	80-60-40	0.08-0.13-0.16	0.09-0.13-0.18	0.10-0.14-0.18	0.10-0.14-0.20	0.12-0.16-0.22
	Duplex Stainless Steels (<30HRC)	35-25-20	60-45-30	0.08-0.13-0.16	0.09-0.13-0.18	0.10-0.14-0.18	0.10-0.14-0.20	0.12-0.16-0.22
K	Grey Cast Iron (<32HRC)	100-80-60	140-120-60	0.25-0.33-0.45	0.28-0.36-0.48	0.30-0.40-0.50	0.32-0.42-0.52	0.35-0.45-0.55
	Moderately Difficult Alloy Cast iron, Nodular Cast Iron (<28HRC)	100-80-60	140-120-60	0.22-0.30-0.42	0.24-0.33-0.45	0.25-0.35-0.48	0.28-0.38-0.48	0.30-0.40-0.50
	Difficult High-alloy Cast Iron, Nodular Cast Iron (<45HRC)	90-70-60	100-90-60	0.16-0.22-0.28	0.18-0.24-0.30	0.20-0.26-0.32	0.22-0.28-0.34	0.23-0.28-0.35

Remark:

1. Make sure work piece and machine are stable and use a precision holder, use hydraulic chucks, high quality collet chucks.
2. Make sure total indicated run-out (TIR) is less than 0.02mm.
3. The recommended cutting condition is suitable for apply water soluble.
4. If the tool size is not in the table, please refer to the table closest to the blade diameter size selection of cutting parameters, adjust cutting parameters according to actual working conditions during processing.

Recommended Cutting Data

D968S High Performance Twist Drills for Stainless Steel



Workpiece		Vc (m/min)		fn (mm/rev)				
				Φ3	Φ4	Φ6	Φ8	Φ10
P	Low-carbon Steels, Long Chipping (<125HB)	100-80-50	140-100-60	0.09-0.13-0.16	0.11-0.15-0.19	0.14-0.19-0.23	0.19-0.25-0.31	0.23-0.30-0.38
	Low-carbon Steels, Short Chipping, Free-cutting Steels (<125HB)	100-75-50	140-100-60	0.09-0.13-0.16	0.11-0.15-0.19	0.14-0.19-0.23	0.19-0.25-0.31	0.23-0.30-0.38
	High-carbon Steels, Medium-carbon Steels (<25HRC)	90-70-45	120-80-60	0.09-0.13-0.16	0.11-0.15-0.19	0.14-0.19-0.23	0.19-0.25-0.31	0.23-0.30-0.38
	Alloy Steels, Tool Steels (<35HRC)	90-70-45	110-80-50	0.09-0.13-0.16	0.11-0.15-0.19	0.14-0.19-0.23	0.19-0.25-0.31	0.23-0.30-0.38
M	Austenitic Stainless Steels (130-200HB)	40-30-20	80-60-40	0.05-0.08-0.10	0.06-0.10-0.12	0.07-0.12-0.14	0.08-0.13-0.18	0.09-0.15-0.20
	High-Strength Austenitic Stainless Steels and Cast Stainless Steels (<25HRC)	40-30-20	80-60-40	0.03-0.06-0.08	0.04-0.08-0.10	0.05-0.08-0.10	0.06-0.10-0.12	0.07-0.11-0.14
	Duplex Stainless Steels (<30HRC)	35-25-20	60-45-30	0.03-0.06-0.08	0.04-0.08-0.10	0.05-0.08-0.10	0.06-0.10-0.12	0.07-0.11-0.14
S	Iron-based Heat-resistant Alloys (160-260HB)	-	50-40-25	0.03-0.05-0.08	0.04-0.07-0.10	0.05-0.09-0.10	0.06-0.10-0.12	0.07-0.12-0.14
	Cobalt-based Heat-resistant Alloys Cobalt-based Heat-resistant Alloys (250-450HB)	-	50-40-25	0.03-0.05-0.08	0.04-0.07-0.10	0.05-0.09-0.10	0.06-0.10-0.12	0.07-0.12-0.14
	Nickel-based Heat-resistant Alloys (160-450HB)	-	50-40-25	0.03-0.05-0.07	0.04-0.07-0.09	0.05-0.09-0.10	0.06-0.10-0.12	0.07-0.12-0.14
	Titanium and Titanium Alloys (300-400HB)	-	45-35-20	0.03-0.04-0.06	0.04-0.06-0.08	0.05-0.08-0.10	0.06-0.09-0.11	0.07-0.10-0.12

Remark:

1. Make sure work piece and machine are stable and use a precision holder, use hydraulic chucks, high quality collet chucks.
2. Make sure total indicated run-out (TIR) is less than 0.02mm.
3. The recommended cutting condition is suitable for apply water soluble.
4. If the tool size is not in the table, please refer to the table closest to the blade diameter size selection of cutting parameters, adjust cutting parameters according to actual working conditions during processing.

Recommended Cutting Data

D968S High Performance Twist Drills for Stainless Steel

Workpiece		Vc (m/min)		fn (mm/rev)				
				Φ12	Φ14	Φ16	Φ18	Φ20
P	Low-carbon Steels, Long Chipping (<125HB)	100-80-50	140-100-60	0.24-0.33-0.41	0.28-0.38-0.45	0.30-0.42-0.50	0.33-0.42-0.50	0.34-0.43-0.51
	Low-carbon Steels, Short Chipping, Free-cutting Steels (<125HB)	100-75-50	140-100-60	0.24-0.33-0.41	0.28-0.38-0.45	0.30-0.42-0.50	0.33-0.42-0.50	0.34-0.43-0.51
	High-carbon Steels, Medium-carbon Steels (<25HRC)	90-70-45	120-80-60	0.24-0.33-0.41	0.28-0.38-0.45	0.30-0.42-0.50	0.33-0.42-0.50	0.34-0.43-0.51
	Alloy Steels, Tool Steels (<35HRC)	90-70-45	110-80-50	0.24-0.33-0.41	0.28-0.38-0.45	0.30-0.42-0.50	0.33-0.42-0.50	0.34-0.43-0.51
M	Austenitic Stainless Steels (130-200HB)	40-30-20	80-60-40	0.10-0.17-0.22	0.11-0.18-0.24	0.12-0.20-0.24	0.13-0.22-0.26	0.14-0.24-0.28
	High-Strength Austenitic Stainless Steels and Cast Stainless Steels (<25HRC)	40-30-20	80-60-40	0.08-0.13-0.16	0.09-0.13-0.18	0.10-0.14-0.18	0.10-0.14-0.20	0.12-0.16-0.22
	Duplex Stainless Steels (<30HRC)	35-25-20	60-45-30	0.08-0.13-0.16	0.09-0.13-0.18	0.10-0.14-0.18	0.10-0.14-0.20	0.12-0.16-0.22
S	Iron-based Heat-resistant Alloys (160-260HB)	-	50-40-25	0.08-0.14-0.16	0.09-0.15-0.18	0.10-0.17-0.18	0.10-0.16-0.20	0.12-0.18-0.22
	Cobalt-based Heat-resistant Alloys Cobalt-based Heat-resistant Alloys (250-450HB)	-	50-40-25	0.08-0.14-0.16	0.09-0.15-0.18	0.10-0.17-0.18	0.10-0.16-0.20	0.12-0.18-0.22
	Nickel-based Heat-resistant Alloys (160-450HB)	-	50-40-25	0.08-0.14-0.16	0.09-0.15-0.18	0.10-0.17-0.18	0.10-0.16-0.20	0.12-0.18-0.22
	Titanium and Titanium Alloys (300-400HB)	-	45-35-20	0.08-0.12-0.14	0.09-0.13-0.16	0.10-0.14-0.16	0.10-0.15-0.18	0.12-0.16-0.20

【Remark:

1. Make sure work piece and machine are stable and use a precision holder, use hydraulic chucks, high quality collet chucks.
2. Make sure total indicated run-out(TIR) is less than 0.02mm.
3. The recommended cutting condition is suitable for apply water soluble.
4. If the tool size is not in the table, please refer to the table closest to the blade diameter size selection of cutting parameters, adjust cutting parameters according to actual working conditions during processing.

Recommended Cutting Data

D938 3D/5D Twist Drills for Steel

Workpiece		Vc (m/min)		fn (mm/rev)				
				Φ3	Φ4	Φ6	Φ8	Φ10
P	Low-carbon Steels, Long Chipping (< 125HB)	120-80-50	140-100-60	0.10-0.15-0.20	0.10-0.15-0.20	0.14-0.19-0.25	0.16-0.22-0.32	0.16-0.22-0.35
	Low-carbon Steels, Short Chipping, Free-cutting Steels (< 125HB)	120-75-50	140-100-60	0.10-0.15-0.20	0.10-0.15-0.20	0.14-0.19-0.25	0.16-0.22-0.32	0.16-0.22-0.35
	High-carbon Steels, Medium-carbon Steels (< 25HRC)	120-70-45	120-80-60	0.10-0.15-0.20	0.10-0.15-0.20	0.14-0.19-0.25	0.16-0.22-0.30	0.16-0.22-0.32
	Alloy Steels, Tool Steels. (<35HRC)	100-70-45	110-80-60	0.09-0.13-0.16	0.09-0.13-0.16	0.12-0.17-0.23	0.14-0.20-0.28	0.14-0.20-0.30
	Alloy Steels, Tool Steels. (35-48HRC)	80-60-35	90-60-35	0.08-0.11-0.14	0.08-0.11-0.14	0.08-0.14-0.20	0.09-0.16-0.25	0.09-0.16-0.28
	PH and Ferrite/ Martensitic Steels (<35HRC)	70-50-30	90-60-30	0.05-0.08-0.11	0.05-0.08-0.11	0.07-0.12-0.17	0.08-0.14-0.20	0.08-0.14-0.23
	High-Strength PH and Ferrite/ Martensitic Steels (35-48HRC)	70-45-25	80-50-30	0.04-0.06-0.08	0.04-0.06-0.08	0.06-0.10-0.14	0.08-0.13-0.18	0.08-0.13-0.20
K	Grey Cast Iron (<32HRC)	140-100-60	160-120-60	0.13-0.17-0.20	0.15-0.20-0.23	0.17-0.25-0.30	0.20-0.27-0.35	0.23-0.30-0.40
	Moderately Difficult Alloy Cast iron, Nodular Cast Iron (< 28HRC)	120-80-60	140-100-60	0.11-0.15-0.18	0.13-0.17-0.20	0.15-0.20-0.25	0.17-0.25-0.32	0.20-0.28-0.36
	Difficult High-alloy Cast Iron, Nodular Cast Iron (<45HRC)	100-70-50	100-80-50	0.06-0.09-0.11	0.08-0.10-0.13	0.10-0.13-0.16	0.12-0.16-0.20	0.14-0.20-0.26

Remark:

1. Make sure work piece and machine are stable and use a precision holder, use hydraulic chucks, high quality collet chucks.
2. Make sure total indicated run-out(TIR) is less than 0.02mm.
3. The recommended cutting condition is suitable for apply water soluble.
4. If the tool size is not in the table, please refer to the table closest to the blade diameter size selection of cutting parameters, adjust cutting parameters according to actual working conditions during processing.

Recommended Cutting Data

D938 3D/5D Twist Drills for Steel

Workpiece		Vc (m/min)		fn (mm/rev)				
				Φ12	Φ14	Φ16	Φ18	Φ20
P	Low-carbon Steels, Long Chipping (< 125HB)	120-80-50	140-100-60	0.18-0.28-0.40	0.22-0.32-0.45	0.22-0.32-0.45	0.25-0.38-0.50	0.25-0.38-0.50
	Low-carbon Steels, Short Chipping, Free-cutting Steels (< 125HB)	120-75-50	140-100-60	0.18-0.28-0.40	0.22-0.32-0.45	0.22-0.32-0.45	0.25-0.38-0.50	0.25-0.38-0.50
	High-carbon Steels, Medium-carbon Steels (< 25HRC)	120-70-45	120-80-60	0.18-0.28-0.38	0.22-0.32-0.45	0.22-0.32-0.45	0.25-0.38-0.50	0.25-0.38-0.50
	Alloy Steels, Tool Steels. (<35HRC)	100-70-45	110-80-60	0.15-0.23-0.34	0.18-0.25-0.38	0.18-0.25-0.38	0.20-0.30-0.40	0.20-0.30-0.40
	Alloy Steels, Tool Steels. (35-48HRC)	80-60-35	90-60-35	0.11-0.19-0.30	0.12-0.22-0.32	0.12-0.22-0.32	0.14-0.24-0.34	0.14-0.24-0.34
	PH and Ferrite/ Martensitic Steels (<35HRC)	70-50-30	90-60-30	0.10-0.18-0.28	0.12-0.20-0.30	0.12-0.20-0.30	0.14-0.24-0.32	0.14-0.24-0.32
	High-Strength PH and Ferrite/ Martensitic Steels (35-48HRC)	70-45-25	80-50-30	0.10-0.18-0.28	0.12-0.20-0.30	0.12-0.20-0.30	0.14-0.24-0.32	0.14-0.24-0.32
K	Grey Cast Iron (<32HRC)	140-100-60	160-120-60	0.25-0.33-0.45	0.28-0.36-0.48	0.30-0.40-0.50	0.32-0.42-0.52	0.35-0.45-0.55
	Moderately Difficult Alloy Cast iron, Nodular Cast Iron (<28HRC)	120-80-60	140-100-60	0.22-0.30-0.42	0.24-0.33-0.45	0.25-0.35-0.48	0.28-0.38-0.48	0.30-0.40-0.50
	Difficult High-alloy Cast Iron, Nodular Cast Iron (<45HRC)	100-70-50	100-80-50	0.16-0.22-0.28	0.18-0.24-0.30	0.20-0.26-0.32	0.22-0.28-0.34	0.23-0.28-0.35

Remark:

1. Make sure work piece and machine are stable and use a precision holder, use hydraulic chucks, high quality collet chucks.
2. Make sure total indicated run-out(TIR) is less than 0.02mm.
3. The recommended cutting condition is suitable for apply water soluble.
4. If the tool size is not in the table, please refer to the table closest to the blade diameter size selection of cutting parameters, adjust cutting parameters according to actual working conditions during processing.

Recommended Cutting Data

D938 8D/12D/15D Twist Drills for Steel

Workpiece	Vc (m/min)		fn (mm/rev)			
			Φ3	Φ4	Φ6	Φ8
P	Low-carbon Steels, Long Chipping (< 125HB)	140-100-60	0.10-0.15-0.20	0.10-0.15-0.20	0.14-0.19-0.25	0.16-0.22-0.32
	Low-carbon Steels, Short Chipping, Free-cutting Steels (< 125HB)	140-100-60	0.10-0.15-0.20	0.10-0.15-0.20	0.14-0.19-0.25	0.16-0.22-0.32
	High-carbon Steels, Medium-carbon Steels (< 25HRC)	120-80-60	0.10-0.15-0.20	0.10-0.15-0.20	0.14-0.19-0.25	0.16-0.22-0.30
	Alloy Steels, Tool Steels. (<35HRC)	110-80-60	0.09-0.13-0.16	0.09-0.13-0.16	0.12-0.17-0.23	0.14-0.20-0.28
	Alloy Steels, Tool Steels. (35-48HRC)	90-60-35	0.08-0.11-0.14	0.08-0.11-0.14	0.08-0.14-0.20	0.09-0.16-0.25
	PH and Ferrite/ Martensitic Steels (<35HRC)	90-60-30	0.05-0.08-0.11	0.05-0.08-0.11	0.07-0.12-0.17	0.08-0.14-0.20
	High-Strength PH and Ferrite/ Martensitic Steels (35-48HRC)	80-50-30	0.04-0.06-0.08	0.04-0.06-0.08	0.06-0.10-0.14	0.08-0.13-0.18
M	Austenitic Stainless Steels(130-200HB)	60-50-40	0.04-0.08-0.10	0.04-0.08-0.10	0.06-0.10-0.12	0.06-0.10-0.12
	High-Strength Austenitic Stainless Steels and Cast Stainless Steels (< 25HRC)	60-50-40	0.04-0.06-0.08	0.04-0.06-0.08	0.06-0.08-0.10	0.06-0.08-0.10
	Duplex Stainless Steels (<30HRC)	50-40-30	0.04-0.06-0.08	0.04-0.06-0.08	0.06-0.08-0.10	0.06-0.08-0.10
K	Grey Cast Iron (<32HRC)	160-120-60	0.13-0.17-0.20	0.15-0.20-0.23	0.17-0.25-0.30	0.20-0.27-0.35
	Moderately Difficult Alloy Cast iron, Nodular Cast Iron (<28HRC)	140-100-60	0.11-0.15-0.18	0.13-0.17-0.20	0.15-0.20-0.25	0.17-0.25-0.32
	Difficult High-alloy Cast Iron, Nodular Cast Iron(<45HRC)	100-80-50	0.06-0.09-0.11	0.08-0.10-0.13	0.10-0.13-0.16	0.12-0.16-0.20

Remark:

1. Make sure work piece and machine are stable and use a precision holder, use hydraulic chucks, high quality collet chucks.
2. Make sure total indicated run-out(TIR) is less than 0.02mm.
3. The recommended cutting condition is suitable for apply water soluble.
4. If the tool size is not in the table, please refer to the table closest to the blade diameter size selection of cutting parameters, adjust cutting parameters according to actual working conditions during processing.

Recommended Cutting Data

D938 8D/12D/15D Twist Drills for Steel

Workpiece	Vc (m/min)		fn (mm/rev)			
			Φ10	Φ12	Φ14	Φ16
P	Low-carbon Steels, Long Chipping (< 125HB)	140-100-60	0.16-0.22-0.35	0.18-0.28-0.40	0.22-0.32-0.45	0.22-0.32-0.45
	Low-carbon Steels, Short Chipping, Free-cutting Steels (< 125HB)	140-100-60	0.16-0.22-0.35	0.18-0.28-0.40	0.22-0.32-0.45	0.22-0.32-0.45
	High-carbon Steels, Medium-carbon Steels (< 25HRC)	120-80-60	0.16-0.22-0.32	0.18-0.28-0.38	0.22-0.32-0.45	0.22-0.32-0.45
	Alloy Steels, Tool Steels. (<35HRC)	110-80-60	0.14-0.20-0.30	0.15-0.23-0.34	0.18-0.25-0.38	0.18-0.25-0.38
	Alloy Steels, Tool Steels. (35-48HRC)	90-60-35	0.09-0.16-0.28	0.11-0.19-0.30	0.12-0.22-0.32	0.12-0.22-0.32
	PH and Ferrite/ Martensitic Steels (<35HRC)	90-60-30	0.08-0.14-0.23	0.10-0.18-0.28	0.12-0.20-0.30	0.12-0.20-0.30
	High-Strength PH and Ferrite/ Martensitic Steels (35-48HRC)	80-50-30	0.08-0.13-0.20	0.10-0.18-0.28	0.12-0.20-0.30	0.12-0.20-0.30
M	Austenitic Stainless Steels(130-200HB)	60-50-40	0.08-0.12-0.16	0.08-0.12-0.16	0.10-0.14-0.18	0.10-0.14-0.18
	High-Strength Austenitic Stainless Steels and Cast Stainless Steels (< 25HRC)	60-50-40	0.08-0.10-0.12	0.08-0.10-0.12	0.10-0.12-0.14	0.10-0.12-0.14
	Duplex Stainless Steels (<30HRC)	50-40-30	0.08-0.10-0.12	0.08-0.10-0.12	0.10-0.12-0.14	0.10-0.12-0.14
K	Grey Cast Iron (<32HRC)	160-120-60	0.23-0.30-0.40	0.25-0.33-0.45	0.28-0.36-0.48	0.30-0.40-0.50
	Moderately Difficult Alloy Cast iron, Nodular Cast Iron (<28HRC)	140-100-60	0.20-0.28-0.36	0.22-0.30-0.42	0.24-0.33-0.45	0.25-0.35-0.48
	Difficult High-alloy Cast Iron, Nodular Cast Iron(<45HRC)	100-80-50	0.14-0.20-0.26	0.16-0.22-0.28	0.18-0.24-0.30	0.20-0.26-0.32

Remark:

1. Make sure work piece and machine are stable and use a precision holder, use hydraulic chucks, high quality collet chucks.
2. Make sure total indicated run-out(TIR) is less than 0.02mm.
3. The recommended cutting condition is suitable for apply water soluble.
4. If the tool size is not in the table, please refer to the table closest to the blade diameter size selection of cutting parameters, adjust cutting parameters according to actual working conditions during processing.

Recommended Cutting Data

D101/D102/D103 NC Centre Drills

Workpiece	Vc (m/min)		fn (mm/rev)				
			Φ4	Φ6	Φ8	Φ10	
P	Low-carbon Steels, Long Chipping (<125HB)	130-100-60	-	0.12-0.15-0.18	0.14-0.17-0.20	0.16-0.20-0.26	0.18-0.24-0.3
	Low-carbon Steels, Short Chipping, Free-cutting Steels (<125HB)	120-100-60	-	0.10-0.14-0.18	0.14-0.16-0.20	0.16-0.20-0.24	0.18-0.24-0.3
	High-carbon Steels, Medium-carbon Steels (<25HRC)	110-80-60	-	0.10-0.13-0.16	0.12-0.15-0.18	0.14-0.18-0.22	0.16-0.20-0.24
	Alloy Steels, Tool Steels. (<35HRC)	110-80-60	-	0.10-0.13-0.16	0.12-0.15-0.18	0.14-0.18-0.22	0.16-0.20-0.24
	Alloy Steels, Tool Steels. (35-48HRC)	100-80-60	-	0.10-0.12-0.16	0.12-0.14-0.18	0.14-0.16-0.20	0.16-0.20-0.24
	PH and Ferrite/ Martensitic Steels (<35HRC)	100-80-60	-	0.10-0.12-0.16	0.12-0.14-0.18	0.14-0.16-0.20	0.16-0.20-0.24
K	Grey Cast Iron (<32HRC)	140-120-60	-	0.12-0.20-0.26	0.17-0.26-0.32	0.20-0.32-0.40	0.25-0.30-0.36
	Moderately Difficult Alloy Cast iron, Nodular Cast Iron (<28HRC)	130-105-60	-	0.12-0.18-0.24	0.15-0.20-0.27	0.17-0.22-0.30	0.20-0.26-0.32
	Difficult High-alloy Cast Iron, Nodular Cast Iron (<45HRC)	120-90-60	-	0.10-0.16-0.22	0.10-0.13-0.16	0.13-0.17-0.21	0.15-0.20-0.26
N	Wrought Aluminium Alloys(Si<12%)	150-120-60	-	0.12-0.20-0.26	0.17-0.26-0.32	0.20-0.32-0.40	0.25-0.30-0.36
	Cast Aluminium Alloys(Si<12%)	150-120-60	-	0.12-0.18-0.24	0.15-0.20-0.27	0.17-0.22-0.30	0.20-0.26-0.32
	Cast Aluminium Alloys(Si>12%)	150-120-60	-	0.10-0.13-0.16	0.12-0.15-0.18	0.14-0.18-0.22	0.16-0.20-0.24
	Copper, Copper Alloys (<200HB)	150-120-60	-	0.10-0.12-0.16	0.12-0.14-0.18	0.14-0.16-0.20	0.16-0.20-0.24

【Remark:

1. Make sure work piece and machine are stable and use a precision holder, use hydraulic chucks, high quality collet chucks.
2. Make sure total indicated run-out(TIR) is less than 0.02mm.
3. The recommended cutting condition is suitable for apply water soluble.
4. If the tool size is not in the table, please refer to the table closest to the blade diameter size selection of cutting parameters, adjust cutting parameters according to actual working conditions during processing.

Recommended Cutting Data

D101/D102/D103 NC Centre Drills

Workpiece		Vc (m/min)		fn (mm/rev)			
				Φ12	Φ14	Φ16	Φ20
P	Low-carbon Steels, Long Chipping (<125HB)	130-100-60	-	0.20-0.26-0.32	0.24-0.30-0.35	0.28-0.34-0.4	0.32-0.38-0.45
	Low-carbon Steels, Short Chipping, Free-cutting Steels (<125HB)	120-100-60	-	0.20-0.26-0.32	0.24-0.28-0.34	0.28-0.34-0.4	0.32-0.38-0.45
	High-carbon Steels, Medium-carbon Steels (<25HRC)	110-80-60	-	0.18-0.24-0.30	0.20-0.26-0.30	0.22-0.28-0.32	0.26-0.32-0.40
	Alloy Steels, Tool Steels. (<35HRC)	110-80-60	-	0.18-0.24-0.30	0.20-0.26-0.30	0.22-0.28-0.32	0.26-0.32-0.40
	Alloy Steels, Tool Steels. (35-48HRC)	100-80-60	-	0.18-0.24-0.30	0.20-0.26-0.30	0.22-0.28-0.32	0.26-0.32-0.40
	PH and Ferrite/ Martensitic Steels (<35HRC)	100-80-60	-	0.18-0.24-0.30	0.20-0.26-0.30	0.22-0.28-0.32	0.26-0.32-0.40
K	Grey Cast Iron (<32HRC)	140-120-60	-	0.26-0.32-0.38	0.28-0.32-0.40	0.30-0.36-0.42	0.32-0.38-0.44
	Moderately Difficult Alloy Cast iron, Nodular Cast Iron (<28HRC)	130-105-60	-	0.22-0.28-0.34	0.24-0.30-0.36	0.26-0.32-0.38	0.30-0.36-0.42
	Difficult High-alloy Cast Iron, Nodular Cast Iron (<45HRC)	120-90-60	-	0.17-0.22-0.28	0.19-0.26-0.31	0.20-0.27-0.33	0.28-0.29-0.35
N	Wrought Aluminium Alloys(Si<12%)	150-120-60	-	0.26-0.32-0.38	0.28-0.32-0.40	0.30-0.36-0.42	0.32-0.38-0.44
	Cast Aluminium Alloys(Si<12%)	150-120-60	-	0.22-0.28-0.34	0.24-0.30-0.36	0.26-0.32-0.38	0.30-0.36-0.42
	Cast Aluminium Alloys(Si>12%)	150-120-60	-	0.18-0.24-0.30	0.20-0.26-0.30	0.22-0.28-0.32	0.26-0.32-0.40
	Copper, Copper Alloys (<200HB)	150-120-60	-	0.18-0.24-0.30	0.20-0.26-0.30	0.22-0.28-0.32	0.26-0.32-0.40

【Remark:

1. Make sure work piece and machine are stable and use a precision holder, use hydraulic chucks, high quality collet chucks.
2. Make sure total indicated run-out(TIR) is less than 0.02mm.
3. The recommended cutting condition is suitable for apply water soluble.
4. If the tool size is not in the table, please refer to the table closest to the blade diameter size selection of cutting parameters, adjust cutting parameters according to actual working conditions during processing.

Recommended Cutting Data

D918 Twist Drills for General Purpose

Workpiece		Vc (m/min)		fn (mm/rev)				
				Φ3	Φ4	Φ6	Φ8	Φ10
P	Low-carbon Steels, Long Chipping (< 125HB)	100-80-50	140-100-60	0.09-0.13-0.16	0.11-0.15-0.19	0.14-0.19-0.23	0.19-0.25-0.31	0.23-0.30-0.38
	Low-carbon Steels, Short Chipping, Free-cutting Steels (<125HB)	100-75-50	140-100-60	0.09-0.13-0.16	0.11-0.15-0.19	0.14-0.19-0.23	0.19-0.25-0.31	0.23-0.30-0.38
	High-carbon Steels, Medium-carbon Steels (< 25HRC)	90-70-45	120-80-60	0.09-0.13-0.16	0.11-0.15-0.19	0.14-0.19-0.23	0.19-0.25-0.31	0.23-0.30-0.38
	Alloy Steels, Tool Steels. (<35HRC)	90-70-45	110-80-50	0.09-0.13-0.16	0.11-0.15-0.19	0.14-0.19-0.23	0.19-0.25-0.31	0.23-0.30-0.38
	Alloy Steels, Tool Steels. (35-48HRC)	80-60-40	90-60-40	0.09-0.12-0.14	0.10-0.14-0.17	0.13-0.17-0.22	0.17-0.23-0.29	0.21-0.28-0.35
	PH and Ferrite/ Martensitic Steels (<35HRC)	70-50-30	80-50-30	0.09-0.12-0.14	0.10-0.14-0.17	0.13-0.17-0.22	0.17-0.23-0.29	0.21-0.28-0.35
M	Austenitic Stainless Steels(130-200HB)	-	50-40-20	0.05-0.08-0.10	0.06-0.10-0.12	0.07-0.12-0.14	0.08-0.13-0.18	0.09-0.15-0.20
	High-Strength Austenitic Stainless Steels and Cast Stainless Steels (< 25HRC)	-	55-40-30	0.03-0.06-0.08	0.04-0.08-0.10	0.05-0.08-0.10	0.06-0.10-0.12	0.07-0.11-0.14
	Duplex Stainless Steels (<30HRC)	-	55-40-20	0.03-0.06-0.08	0.04-0.08-0.10	0.05-0.08-0.10	0.06-0.10-0.12	0.07-0.11-0.14
K	Grey Cast Iron (<32HRC)	100-80-60	140-120-60	0.13-0.17-0.21	0.15-0.20-0.26	0.17-0.26-0.32	0.20-0.32-0.40	0.25-0.36-0.42
	Moderately Difficult Alloy Cast Iron, Nodular Cast Iron (<28HRC)	100-80-60	140-120-60	0.11-0.15-0.18	0.13-0.18-0.22	0.15-0.23-0.27	0.17-0.26-0.38	0.22-0.28-0.38
	Difficult High-alloy Cast Iron, Nodular Cast Iron(<45HRC)	90-70-60	100-90-60	0.06-0.09-0.11	0.08-0.10-0.13	0.10-0.13-0.16	0.13-0.17-0.21	0.15-0.20-0.26
N	Wrought Aluminium Alloys(Si<12%)	-	315-230-90	0.06-0.09-0.11	0.13-0.20-0.26	0.16-0.22-0.28	0.18-0.26-0.32	0.20-0.30-0.38
	Cast Aluminium Alloys(Si<12%)	-	315-230-90	0.06-0.09-0.11	0.13-0.20-0.26	0.16-0.22-0.28	0.18-0.26-0.32	0.20-0.30-0.38
	Cast Aluminium Alloys(Si>12%)	-	270-180-90	0.06-0.09-0.11	0.13-0.20-0.26	0.16-0.22-0.28	0.18-0.26-0.32	0.20-0.30-0.38
	Copper, Copper Alloys (<200HB)	-	180-135-90	0.06-0.09-0.11	0.13-0.20-0.26	0.16-0.22-0.28	0.18-0.26-0.32	0.20-0.30-0.38

Remark:

1. Make sure work piece and machine are stable and use a precision holder, use hydraulic chucks, high quality collet chucks.
2. Make sure total indicated run-out(TIR) is less than 0.02mm.
3. The recommended cutting condition is suitable for apply water soluble.
4. If the tool size is not in the table, please refer to the table closest to the blade diameter size selection of cutting parameters, adjust cutting parameters according to actual working conditions during processing.

Recommended Cutting Data

D918 Twist Drills for General Purpose



Workpiece		Vc (m/min)		fn (mm/rev)				
				Φ12	Φ14	Φ16	Φ18	Φ20
P	Low-carbon Steels, Long Chipping (< 125HB)	100-80-50	140-100-60	0.24-0.33-0.41	0.28-0.38-0.45	0.30-0.42-0.50	0.33-0.42-0.50	0.34-0.43-0.51
	Low-carbon Steels, Short Chipping, Free-cutting Steels (< 125HB)	100-75-50	140-100-60	0.24-0.33-0.41	0.28-0.38-0.45	0.30-0.42-0.50	0.33-0.42-0.50	0.34-0.43-0.51
	High-carbon Steels, Medium-carbon Steels (< 25HRC)	90-70-45	120-80-60	0.24-0.33-0.41	0.28-0.38-0.45	0.30-0.42-0.50	0.33-0.42-0.50	0.34-0.43-0.51
	Alloy Steels, Tool Steels. (<35HRC)	90-70-45	110-80-50	0.24-0.33-0.41	0.28-0.38-0.45	0.30-0.42-0.50	0.33-0.42-0.50	0.34-0.43-0.51
	Alloy Steels, Tool Steels. (35-48HRC)	80-60-40	90-60-40	0.22-0.30-0.37	0.26-0.35-0.41	0.28-0.37-0.44	0.31-0.38-0.46	0.31-0.39-0.47
	PH and Ferrite/ Martensitic Steels (<35HRC)	70-50-30	80-50-30	0.22-0.30-0.37	0.26-0.35-0.41	0.28-0.37-0.44	0.31-0.38-0.46	0.31-0.39-0.47
M	Austenitic Stainless Steels(130-200HB)	-	50-40-20	0.10-0.17-0.22	0.11-0.18-0.24	0.12-0.20-0.24	0.13-0.22-0.26	0.14-0.24-0.28
	High-Strength Austenitic Stainless Steels and Cast Stainless Steels (< 25HRC)	-	55-40-30	0.08-0.13-0.16	0.09-0.13-0.18	0.10-0.14-0.18	0.10-0.14-0.20	0.12-0.16-0.22
	Duplex Stainless Steels (<30HRC)	-	55-40-20	0.08-0.13-0.16	0.09-0.13-0.18	0.10-0.14-0.18	0.10-0.14-0.20	0.12-0.16-0.22
K	Grey Cast Iron (<32HRC)	100-80-60	140-120-60	0.26-0.38-0.46	0.28-0.40-0.50	0.30-0.42-0.52	0.32-0.44-0.54	0.36-0.48-0.56
	Moderately Difficult Alloy Cast iron, Nodular Cast Iron (< 28HRC)	100-80-60	140-120-60	0.22-0.34-0.42	0.24-0.35-0.44	0.26-0.40-0.48	0.30-0.40-0.46	0.34-0.43-0.50
	Difficult High-alloy Cast Iron, Nodular Cast Iron(<45HRC)	90-70-60	100-90-60	0.17-0.22-0.28	0.19-0.26-0.31	0.20-0.27-0.33	0.23-0.28-0.34	0.23-0.29-0.35
N	Wrought Aluminium Alloys(Si<12%)	-	315-230-90	0.22-0.34-0.42	0.24-0.36-0.44	0.28-0.38-0.46	0.32-0.40-0.48	0.34-0.42-0.48
	Cast Aluminium Alloys(Si<12%)	-	315-230-90	0.22-0.34-0.42	0.24-0.36-0.44	0.28-0.38-0.46	0.32-0.40-0.48	0.34-0.42-0.48
	Cast Aluminium Alloys(Si>12%)	-	270-180-90	0.22-0.34-0.42	0.24-0.36-0.44	0.28-0.38-0.46	0.32-0.40-0.48	0.34-0.42-0.48
	Copper, Copper Alloys (<200HB)	-	180-135-90	0.22-0.34-0.42	0.24-0.36-0.44	0.28-0.38-0.46	0.32-0.40-0.48	0.34-0.42-0.48

Remark:

1. Make sure work piece and machine are stable and use a precision holder, use hydraulic chucks, high quality collet chucks.
2. Make sure total indicated run-out(TIR) is less than 0.02mm.
3. The recommended cutting condition is suitable for apply water soluble.
4. If the tool size is not in the table, please refer to the table closest to the blade diameter size selection of cutting parameters, adjust cutting parameters according to actual working conditions during processing.

Recommended Cutting Data

D928 Twist Drills for Cast Iron



Workpiece		Vc (m/min)		fn (mm/rev)				
				Φ3	Φ4	Φ6	Φ8	Φ10
P	Low-carbon Steels, Long Chipping (< 125HB)	100-80-50	140-100-60	0.09-0.13-0.16	0.11-0.15-0.19	0.14-0.19-0.23	0.19-0.25-0.31	0.23-0.30-0.38
	Low-carbon Steels, Short Chipping, Free-cutting Steels (<125HB)	100-75-50	140-100-60	0.09-0.13-0.16	0.11-0.15-0.19	0.14-0.19-0.23	0.19-0.25-0.31	0.23-0.30-0.38
	High-carbon Steels, Medium-carbon Steels (< 25HRC)	90-70-45	100-80-60	0.09-0.13-0.16	0.11-0.15-0.19	0.14-0.19-0.23	0.19-0.25-0.31	0.23-0.30-0.38
	Alloy Steels, Tool Steels. (<35HRC)	90-70-45	100-80-60	0.09-0.13-0.16	0.11-0.15-0.19	0.14-0.19-0.23	0.19-0.25-0.31	0.23-0.30-0.38
K	Grey Cast Iron (<32HRC)	100-80-60	160-140-60	0.13-0.17-0.21	0.15-0.20-0.26	0.17-0.26-0.32	0.20-0.32-0.40	0.25-0.36-0.42
	Moderately Difficult Alloy Cast iron, Nodular Cast Iron (< 28HRC)	100-80-60	140-120-60	0.11-0.15-0.18	0.13-0.18-0.22	0.15-0.23-0.27	0.17-0.26-0.38	0.22-0.28-0.38
	Difficult High-alloy Cast Iron, Nodular Cast Iron (<45HRC)	90-70-60	100-90-60	0.06-0.09-0.11	0.08-0.10-0.13	0.10-0.13-0.16	0.13-0.17-0.21	0.15-0.20-0.26
N	Wrought Aluminium Alloys(Si<12%)	-	315-230-90	0.06-0.09-0.11	0.13-0.20-0.26	0.16-0.22-0.28	0.18-0.26-0.32	0.20-0.30-0.38
	Cast Aluminium Alloys(Si<12%)	-	315-230-90	0.06-0.09-0.11	0.13-0.20-0.26	0.16-0.22-0.28	0.18-0.26-0.32	0.20-0.30-0.38
	Cast Aluminium Alloys(Si>12%)	-	270-180-90	0.06-0.09-0.11	0.13-0.20-0.26	0.16-0.22-0.28	0.18-0.26-0.32	0.20-0.30-0.38

Remark:

1. Make sure work piece and machine are stable and use a precision holder, use hydraulic chucks, high quality collet chucks.
2. Make sure total indicated run-out(TIR) is less than 0.02mm.
3. The recommended cutting condition is suitable for apply water soluble.
4. If the tool size is not in the table, please refer to the table closest to the blade diameter size selection of cutting parameters, adjust cutting parameters according to actual working conditions during processing.

Recommended Cutting Data

D928 Twist Drills for Cast Iron



Workpiece		Vc (m/min)		fn (mm/rev)				
				Φ12	Φ14	Φ16	Φ18	Φ20
P	Low-carbon Steels, Long Chipping (< 125HB)	100-80-50	140-100-60	0.24-0.33-0.41	0.28-0.38-0.45	0.30-0.42-0.50	0.33-0.42-0.50	0.34-0.43-0.51
	Low-carbon Steels, Short Chipping, Free-cutting Steels (< 125HB)	100-75-50	140-100-60	0.24-0.33-0.41	0.28-0.38-0.45	0.30-0.42-0.50	0.33-0.42-0.50	0.34-0.43-0.51
	High-carbon Steels, Medium-carbon Steels (< 25HRC)	90-70-45	100-80-60	0.24-0.33-0.41	0.28-0.38-0.45	0.30-0.42-0.50	0.33-0.42-0.50	0.34-0.43-0.51
	Alloy Steels, Tool Steels. (<35HRC)	90-70-45	100-80-60	0.24-0.33-0.41	0.28-0.38-0.45	0.30-0.42-0.50	0.33-0.42-0.50	0.34-0.43-0.51
K	Grey Cast Iron (<32HRC)	100-80-60	160-140-60	0.26-0.38-0.46	0.28-0.40-0.50	0.30-0.42-0.52	0.32-0.44-0.54	0.36-0.48-0.56
	Moderately Difficult Alloy Cast iron, Nodular Cast Iron (< 28HRC)	100-80-60	140-120-60	0.22-0.34-0.42	0.24-0.35-0.44	0.26-0.40-0.48	0.30-0.40-0.46	0.34-0.43-0.50
	Difficult High-alloy Cast Iron, Nodular Cast Iron (<45HRC)	90-70-60	100-90-60	0.17-0.22-0.28	0.19-0.26-0.31	0.20-0.27-0.33	0.23-0.28-0.34	0.23-0.29-0.35
N	Wrought Aluminium Alloys(Si<12%)	-	315-230-90	0.22-0.34-0.42	0.24-0.36-0.44	0.28-0.38-0.46	0.32-0.40-0.48	0.34-0.42-0.48
	Cast Aluminium Alloys(Si<12%)	-	315-230-90	0.22-0.34-0.42	0.24-0.36-0.44	0.28-0.38-0.46	0.32-0.40-0.48	0.34-0.42-0.48
	Cast Aluminium Alloys(Si>12%)	-	270-180-90	0.22-0.34-0.42	0.24-0.36-0.44	0.28-0.38-0.46	0.32-0.40-0.48	0.34-0.42-0.48



Remark:

1. Make sure work piece and machine are stable and use a precision holder, use hydraulic chucks, high quality collet chucks.
2. Make sure total indicated run-out(TIR) is less than 0.02mm.
3. The recommended cutting condition is suitable for apply water soluble.
4. If the tool size is not in the table, please refer to the table closest to the blade diameter size selection of cutting parameters, adjust cutting parameters according to actual working conditions during processing.

Recommended Cutting Data

D998 Twist Drills for Hardened Steel

Workpiece		Vc (m/min)		fn (mm/rev)				
				Φ3	Φ4	Φ6	Φ8	Φ10
	Hardened SteelsHardened Steels (45-55HRC)	40-30-20	-	0.04-0.06-0.08	0.05-0.08-0.10	0.06-0.10-0.13	0.08-0.12-0.15	0.09-0.14-0.16
	Hardened SteelsHardened Steels (55-60HRC)	30-20-15	-	0.03-0.05-0.07	0.03-0.06-0.08	0.04-0.08-0.12	0.06-0.10-0.13	0.08-0.12-0.15



Workpiece		Vc (m/min)		fn (mm/rev)				
				Φ12	Φ14	Φ16	-	-
	Hardened SteelsHardened Steels (45-55HRC)	40-30-20	-	0.10-0.15-0.17	0.10-0.16-0.20	0.10-0.16-0.20	-	-
	Hardened SteelsHardened Steels (55-60HRC)	30-20-15	-	0.09-0.13-0.16	0.10-0.14-0.17	0.10-0.14-0.17	-	-



Remark:

1. Make sure work piece and machine are stable and use a precision holder, use hydraulic chucks, high quality collet chucks.
2. Make sure total indicated run-out(TIR) is less than 0.02mm.
3. The recommended cutting condition is suitable for apply water soluble.
4. If the tool size is not in the table, please refer to the table closest to the blade diameter size selection of cutting parameters, adjust cutting parameters according to actual working conditions during processing.

Recommended Cutting Data

D713 Straight Flute Drills for Cast Iron

Workpiece	Vc (m/min)		fn (mm/rev)				
			Φ4	Φ6	Φ8	Φ10	Φ12
K Grey Cast Iron (<32HRC) Moderately Difficult Alloy Cast iron, Nodular Cast Iron (< 28HRC) Difficult High-alloy Cast Iron, Nodular Cast Iron (<45HRC)	100-80-60	140-110-60	0.13-0.20-0.26	0.16-0.22-0.28	0.18-0.26-0.32	0.20-0.30-0.38	0.22-0.34-0.42
	100-80-60	120-100-60	0.13-0.18-0.22	0.15-0.20-0.26	0.16-0.22-0.28	0.18-0.26-0.32	0.22-0.30-0.38
	90-70-60	100-90-60	0.08-0.10-0.13	0.10-0.13-0.16	0.13-0.17-0.21	0.15-0.20-0.26	0.17-0.22-0.28
N Cast Aluminium Alloys(Si<12%)	100-80-60	140-110-60	0.13-0.20-0.26	0.16-0.22-0.28	0.18-0.26-0.32	0.20-0.30-0.38	0.22-0.34-0.42

Workpiece	Vc (m/min)		fn (mm/rev)				
			Φ14	Φ16	Φ18	Φ20	-
K Grey Cast Iron (<32HRC) Moderately Difficult Alloy Cast iron, Nodular Cast Iron (< 28HRC) Difficult High-alloy Cast Iron, Nodular Cast Iron (<45HRC)	100-80-60	140-110-60	0.24-0.36-0.44	0.28-0.38-0.46	0.32-0.40-0.48	0.34-0.42-0.48	-
	100-80-60	120-100-60	0.24-0.32-0.40	0.26-0.32-0.40	0.28-0.36-0.42	0.30-0.38-0.46	-
	90-70-60	100-90-60	0.19-0.26-0.31	0.20-0.27-0.33	0.23-0.28-0.34	0.23-0.29-0.35	-
N Cast Aluminium Alloys(Si<12%)	100-80-60	140-110-60	0.24-0.36-0.44	0.28-0.38-0.46	0.32-0.40-0.48	0.34-0.42-0.48	-

Remark:

1. Make sure work piece and machine are stable and use a precision holder, use hydraulic chucks, high quality collet chucks.
2. Make sure total indicated run-out(TIR) is less than 0.02mm.
3. The recommended cutting condition is suitable for apply water soluble.
4. If the tool size is not in the table, please refer to the table closest to the blade diameter size selection of cutting parameters, adjust cutting parameters according to actual working conditions during processing.

Recommended Cutting Data

D612 Triple-angle Drill for Composite Material

Application	Workpiece		Vc	fn
			m/min	mm/rev
Drilling	N	CFRP、GFRP	60	0.08

D973 Twist Drills for Composite and Metal

Application	Workpiece		Vc	fn
			m/min	mm/rev
Drilling	N	CFRP+Aluminium Alloys	60	0.08
	N S	CFRP+Titanium alloy	20	0.05
	N	Aluminium Alloys	60	0.08
	S	Titanium alloy	15	0.05
	M	Stainless Steel	15	0.05

D573 Core Drills for Composite and Metal

Application	Workpiece		Vc	fn
			m/min	mm/rev
Drilling	N	CFRP	60	0.08
	N	CFRP+Aluminium Alloys	60	0.08
	N S	CFRP+Titanium alloy	20	0.05
	N	Aluminium Alloys	60	0.08
	S	Titanium alloy	15	0.05
	M	Stainless Steel	15	0.05

Remark:

CFRP: Glass fiber reinforced plastics GFRP: Glass fiber reinforced plastics

1. Please use the pneumatic tools with better rigidity, drill set and ensure processing stability

2. When using the small size cutting tool, reduce the tool feed 20%-30%

B

Indexable Drilling



Spade Drill Inserts

XR chisel edge regrinding

- Strengthen cutting edges
- Increasing stability

Chip dividing groove

- Reducing cutting width
- Reducing drilling torque

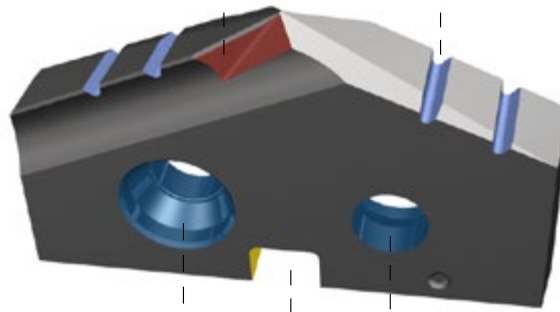

Double Screw holes

- Safe and reliable clamping
- Ensuring drilling Stability

Positioning slot

- Ensuring radial accuracy

Drilling Core

- Thinner Drilling Core, effectively reduce the axial resistance
- Better self-centering

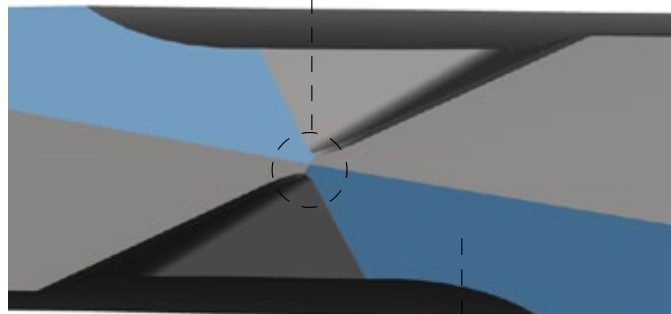

Double flank

- Reduce the friction with the workpiece

Identification of Spade Drill

GSD - 125 - 08D - FC 20 - (S)

①

① Drill Type	
GSD	GESAC Spade Drills

② Bore Diameter	
125	Dia. of mounting position $\Phi 12.5\text{mm}$

②

③ Bore Diameter	
08D	Effective drilling depth is 8D

④ Shank Type	
FC	Flange-Plat
FMT	M—Morse taper shank

③

④

⑤

⑤ Shank Size	
FC	$\Phi 20$ $\Phi 25$ $\Phi 32$
FMT	2 3 4

⑥

⑥ Groove Type	
-	Helical flute
S	Straight flute

Identification of Spade Drill Inserts

M C M G 0200 T3-DS-GM3225

①

① Shape	
M	Spade drill

② Relief Angle	
C	7°

②

③

③ Tolerance	
M	

④ Chip breaker/Hole Symbol	
G	Double-sided

④

⑤

⑥

⑤ Diameter	
0200	20.0mm

⑥ Thickness(mm)	
T3	3.97

⑦

⑧

⑦ Chip breaker Symbol	
Indicates the cutting properties and chipbreaker	

⑧ Grade	
GM3225	

Spade Drill Inserts

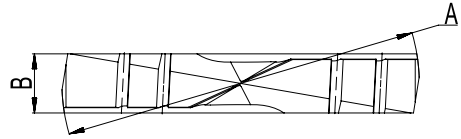

Ordering Code	Diameter (mm)	Thickness (mm)	Grade	Ordering Code	Diameter (mm)	Thickness (mm)	Grade
			GM3225				GM3225
MCMG013003-DS	13.00	3.18	●	MCMG025004-DS	25.00	4.76	●
MCMG013503-DS	13.50		●	MCMG025504-DS	25.50		●
MCMG014003-DS	14.00		●	MCMG026004-DS	26.00		●
MCMG014503-DS	14.50		●	MCMG026504-DS	26.50		●
MCMG015003-DS	15.00		●	MCMG027004-DS	27.00		●
MCMG015503-DS	15.50		●	MCMG027504-DS	27.50		●
MCMG016003-DS	16.00		●	MCMG028004-DS	28.00		●
MCMG016503-DS	16.50		●	MCMG028504-DS	28.50		●
MCMG017003-DS	17.00		●	MCMG029004-DS	29.00		●
MCMG017503-DS	17.50		●	MCMG029504-DS	29.50		●
MCMG0180T3-DS	18.00		●	MCMG030004-DS	30.00		●
MCMG0185T3-DS	18.50		●	MCMG030504-DS	30.50		●
MCMG0190T3-DS	19.00		●	MCMG031004-DS	31.00		●
MCMG0195T3-DS	19.50		●	MCMG031504-DS	31.50		●
MCMG0200T3-DS	20.00	3.97	●	MCMG032004-DS	32.00	●	
MCMG0205T3-DS	20.50		●	MCMG032504-DS	32.50	●	
MCMG0210T3-DS	21.00		●	MCMG033004-DS	33.00	●	
MCMG0215T3-DS	21.50		●	MCMG033504-DS	33.50	●	
MCMG0220T3-DS	22.00		●	MCMG034004-DS	34.00	●	
MCMG0225T3-DS	22.50		●	MCMG034504-DS	34.50	●	
MCMG0230T3-DS	23.00		●	MCMG035004-DS	35.00	●	
MCMG0235T3-DS	23.50		●	MCMG035504-DS	35.50	●	
MCMG0240T3-DS	24.00		●	MCMG036004-DS	36.00	●	
MCMG0245T3-DS	24.50		●				

● Stock ○ Available upon order

The Lateral Fixation Type Flange Shank and Helical Flute Holder

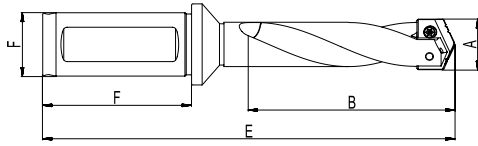

Ordering Code	Drill Insert Range A	Max. Drill Depth B	Overall Length E	Shank F		Screw	Wrench				
				Dia.	Length						
GSD-125-04D-FC20	13.0 ~ 15.0	63.5	142.1	20.0	50.0	PSI52M025060-03712C	PTT08PC				
GSD-125-07D-FC20		114.3	192.9								
GSD-125-11D-FC20		177.8	256.4								
GSD-150-03D-FC20		63.5	142.1								
GSD-150-06D-FC20	15.5 ~ 17.5	114.3	192.9	25.0	56.0	PSI52M030075-04212C	PTT09PC				
GSD-150-10D-FC20		177.8	256.4								
GSD-175-05D-FC25	18.0 ~ 21.5	117.5	210.8					25.0	56.0	PSI52M030075-04212C	PTT09PC
GSD-175-07D-FC25		168.3	261.6								
GSD-175-12D-FC25		269.9	363.2								
GSD-215-04D-FC25		117.5	210.8								
GSD-215-07D-FC25	22.0 ~ 24.0	168.3	261.6	32.0	60.0	PSI52M040095-05218C	PTT158PC				
GSD-215-11D-FC25		269.9	363.2								
GSD-245-04D-FC32	25.0 ~ 29.0	136.5	239.4					32.0	60.0	PSI52M040095-05218C	PTT158PC
GSD-245-06D-FC32		187.3	290.2								
GSD-245-09D-FC32		288.9	391.8								
GSD-295-03D-FC32		136.5	239.4								
GSD-295-05D-FC32	30.0 ~ 36.0	187.3	290.2	32.0	60.0	PSI52M040095-05218C	PTT158PC				
GSD-295-08D-FC32		288.9	391.8								

● Stock ○ Available upon order

The Lateral Fixation Type Flange Shank and Straight Flute Holder

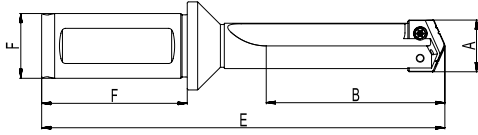

Ordering Code	Drill Insert Range A	Max. Drill Depth B	Overall Length E	Shank F		Screw	Wrench
				Dia.	Length		
GSD-125-01D-FC20-S	13.0 ~ 15.0	22.2	97.6	20.0	50.0	PSI52M025060-03712C	PTT08PC
GSD-125-02D-FC20-S		34.9	113.5				
GSD-125-19D-FC20-S		295.0	373.9				
GSD-125-25D-FC20-S		387.0	466.0				
GSD-150-01D-FC20-S	15.5 ~ 17.5	22.2	97.6	25.0	56.0	PSI52M030075-04212C	PTT09PC
GSD-150-02D-FC20-S		34.9	113.5				
GSD-150-16D-FC20-S		295.0	373.9				
GSD-150-22D-FC20-S		387.0	466.0				
GSD-175-02D-FC25-S	18.0 ~ 21.5	47.6	131.8	32.0	60.0	PSI52M040095-05218C	PTT158PC
GSD-175-03D-FC25-S		66.7	163.2				
GSD-175-21D-FC25-S		457.0	550.5				
GSD-175-26D-FC25-S		569.0	658.5				
GSD-215-01D-FC25-S	22.0 ~ 24.0	47.6	131.8	32.0	60.0	PSI52M040095-05218C	PTT158PC
GSD-215-02D-FC25-S		66.7	163.2				
GSD-215-19D-FC25-S		457.0	550.5				
GSD-215-23D-FC25-S		569.0	658.5				
GSD-245-01D-FC32-S	25.0 ~ 29.0	57.2	148.5	32.0	60.0	PSI52M040095-05218C	PTT158PC
GSD-245-02D-FC32-S		85.7	188.6				
GSD-245-17D-FC32-S		511.0	614.1				
GSD-245-23D-FC32-S		692.0	795.1				
GSD-295-01D-FC32-S	30.0 ~ 36.0	57.2	148.5	32.0	60.0	PSI52M040095-05218C	PTT158PC
GSD-295-02D-FC32-S		85.7	188.6				
GSD-295-14D-FC32-S		511.0	614.1				
GSD-295-19D-FC32-S		692.0	795.1				

● Stock ○ Available upon order

The Morse Taper-shank and Helical Flute Holder

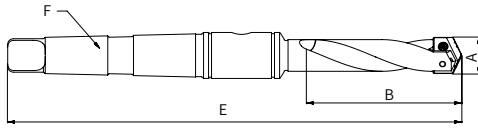

Ordering Code	Drill Insert Range A	Max. Drill Depth B	Overall Length E	Shank F	Screw	Wrench
GSD-125-02D-FMT2	13.0 ~ 15.0	35.0	164.3	FMT2	PSI52M025060-03712C	PTT08PC
GSD-125-04D-FMT2		63.5	192.9			
GSD-125-07D-FMT2		114.3	243.7			
GSD-125-11D-FMT2		177.8	307.2			
GSD-150-02D-FMT2	15.5 ~ 17.5	35.0	164.3			
GSD-150-03D-FMT2		63.5	192.9			
GSD-150-06D-FMT2		114.3	243.7			
GSD-150-10D-FMT2		177.8	307.2			
GSD-175-03D-FMT3	18.0 ~ 21.5	69.8	232.5	FMT3	PSI52M030075-04212C	PTT09PC
GSD-175-05D-FMT3		120.7	283.3			
GSD-175-07D-FMT3		171.5	334.2			
GSD-175-12D-FMT3		273.1	435.8			
GSD-215-02D-FMT3	22.0 ~ 24.0	69.8	232.5			
GSD-215-05D-FMT3		120.7	283.3			
GSD-215-07D-FMT3		171.5	334.2			
GSD-215-11D-FMT3		273.1	435.8			
GSD-245-02D-FMT4	25.0 ~ 29.0	85.7	273.8	FMT4	PSI52M040095-05218C	PTT158PC
GSD-245-04D-FMT4		136.5	324.6			
GSD-245-06D-FMT4		187.3	375.4			
GSD-245-09D-FMT4		289.0	477.0			
GSD-295-02D-FMT4	30.0 ~ 35.0	85.7	281.0			
GSD-295-04D-FMT4		136.5	331.8			
GSD-295-05D-FMT4		187.3	382.6			
GSD-295-08D-FMT4		289.0	484.2			

● Stock ○ Available upon order

The Morse Taper-shank and Straight Flute Holder

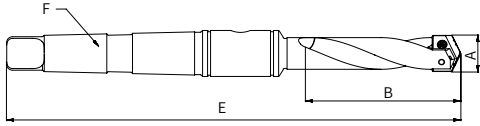

Ordering Code	Drill Insert Range A	Max. Drill Depth B	Overall Length E	Shank F	Screw	Wrench
GSD-125-02D-FMT2-S	13.0 ~ 15.0	35.0	164.3	FMT2	PSI52M025060-03712C	PTT08PC
GSD-150-02D-FMT2-S	15.5 ~ 17.5	35.0	164.3			
GSD-175-03D-FMT3-S	18.0 ~ 21.5	69.8	232.5	FMT3	PSI52M030075-04212C	PTT09PC
GSD-215-02D-FMT3-S	22.0 ~ 24.0	69.8	232.5			
GSD-245-02D-FMT4-S	25.0 ~ 29.0	85.7	273.8	FMT4	PSI52M040095-05218C	PTT158PC
GSD-295-02D-FMT4-S	30.0 ~ 35.0	85.7	281.0			

● Stock ○ Available upon order

Spade Drill Body Parts

Screw		Wrench	
Type	Ordering Code	Type	Ordering Code
SI52M2.5*6.0	PSI52M025060-03712C	T08	PTT08PC
SI52M3.0*7.5	PSI52M030075-04212C	T09	PTT09PC
SI52M4.0*9.5	PSI52M040095-05218C	T15	PTT15PC

Recommended Cutting Data

GSD series spade drill

	Workpiece Materials	Material Hardness (HB)	Recommended Cutting Speed (m/min)	Feed (mm/rev)*Refer toDiameter Range *		
				Ø13.0 – 17.5	Ø18.0 – 24.0	Ø25.0 – 35.0
P	Low Carbon Steel	85–275	(100) 80 – 120	0.18-0.22	0.24-0.28	0.25-0.30
	Medium Carbon Steel	125– 325	(90) 80 – 105	0.18-0.22	0.21-0.28	0.28-0.32
	Alloy Steel	125– 375	(80) 60 – 100	0.12-0.16	0.16-0.22	0.22-0.28
	High Alloy Steel	225– 400	(70) 50 – 90	0.12-0.16	0.15-0.20	0.20-0.25
	Structural Steel	100– 350	(80) 60–100	0.16-0.20	0.18-0.22	0.22-0.28
M	Stainless Steel 300 Series	135 – 275	(60) 40 –70	0.12-0.16	0.16-0.20	0.22-0.26
	Stainless Steel 400 Series	185 – 350	(50) 40 – 60	0.15-0.18	0.18-0.22	0.22-0.26
	Duplex Stainless Steel	135– 275	(40) 30– 50	0.10-0.15	0.15-0.18	0.18-0.22
K	Forged cast iron	150 – 230	(100) 80–120	0.18-0.25	0.25-0.30	0.30-0.35
	Gray cast iron	150 – 230	(100) 80–120	0.18-0.25	0.25-0.30	0.30-0.35
	Nodular cast iron	160 – 260	(80) 60–100	0.15-0.20	0.25-0.28	0.28-0.38

HOLDERS With different length

Parameters	Length of different holders				
	Drill Depth < 8D	8D ≥ Drill Depth < 12D	12D ≥ Drill Depth < 16D	16D ≥ Drill Depth < 20D	20D ≥ Drill Depth
Speed	Refer to the above sheet	0.9	0.85	0.8	0.75
Feed	Refer to the above sheet		0.95	0.9	0.9

Note: The parameters recommended in the table are based on the premise of perfect equipment and efficiency. Please according to the actual equipment situation, reduce the speed and feed (speed reduced by 20%, feed reduced by 10%) when application.



Indexable Deep Drill Body Identification

GD 600 A – 016.10 S E 4



① Tool Type		③ Minor Series Code		⑤ Tube Type		⑥ Connection Type		⑦ Thread Number	
GD	Indexable Deep Drill	A	SubfamilyA	S	Single Tube	E	External Thread Connection	4	4Start Threads
② Major Series Code		other		D		I			
600	Indexable Type	standard		Double Tube		Internal Thread Connection			
602	Brazed Type	④ Tool Diameter							
		016.10	Dia.= Ø16.10						

Indexable Deep Drill Body List

Type	Series	Figure	Application	Advantage
Indexable Deep Drill	GD600		Deep hole drilling for general materials Dia.: Φ38 ~ Φ107mm Max. Depth: 100xD	Screw Locking High productivity, Lowest cost per hole, Good performance consistence
	GD602B		Deep hole drilling for general materials Dia.: ≤ Φ25mm Max. Depth: 100xD	Brazed Multi-edge design, highly polish hole

GD600 系列

TPMT

Deep Hole Drill Inserts

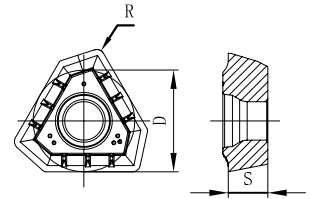

Model Type	Grade	Dimension(mm)				Stock
		D	S	R	W	
TPMT140308-ED	GA4230	8.45	3.50	0.80	-	●
TPMT1704DD	GA4230	10.30	4.00	0.80	-	●
TPMT2405DD	GA4230	14.20	5.50	1.20	-	●
TPMT280716-ED	GA4230	17.00	7.50	1.60	-	●

● Stock ○ Order

NPMT

Deep Hole Drill Inserts

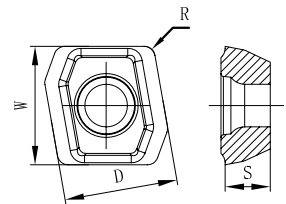

ModelType	Grade	Dimension(mm)				Stock
		D	S	R	W	
NPMT0803DD	GA4230	8.00	3.18	0.80	8.36	○

● Stock ○ Order

GD600

Deep Hole Drill Body

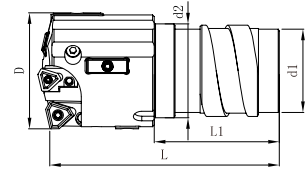

Ordering Code	D	L	L1	d1	d2
GD600-XXX.XXSE4	Ø38.00-39.60	85	37	27	30
GD600-XXX.XXSE4	Ø39.61-43.00	85	37	30	33
GD600-XXX.XXSE4	Ø43.01-47.00	95	37	33	36
GD600-XXX.XXSE4	Ø47.01-51.70	95	37	36	39
GD600-XXX.XXSE4	Ø51.71-56.20	100	41	39.5	43
GD600-XXX.XXSE4	Ø56.21-60.60	110	41	43.5	47
GD600-XXX.XXSE4	Ø60.61-65.00	110	77	47	52
GD600-XXX.XXSE4	Ø65.01-66.99	150	77	47	52
GD600-XXX.XXSE4	Ø67.00-72.99	150	77	53	58
GD600-XXX.XXSE4	Ø73.00-79.99	150	77	58	63
GD600-XXX.XXSE4	Ø80.00-86.99	180	100	64	70
GD600-XXX.XXSE4	Ø87.00-99.99	180	100	71	77
GD600-XXX.XXSE4	Ø100.00-106.99	180	100	83	89

Note: All deep hole drill bodies are non-standard customized, requiring the customer to provide the diameter and interface form, the default is sandvik interface form.

GD600 Series

Insert Assembly		Diameter (mm)					
		Ø38.00-39.60	Ø39.61-43.00	Ø43.01-47.00	Ø47.01-51.70	Ø51.71-56.20	Ø56.21-60.60
Insert	Internal	NPMT0803DD	NPMT0803DD	NPMT0803DD	TPMT140308-ED	TPMT140308-ED	TPMT140308-ED
	Central	NPMT0803DD	NPMT0803DD	TPMT140308-ED	TPMT140308-ED	TPMT140308-ED	TPMT1704DD
	External	NPMT0803DD	TPMT140308-ED	TPMT140308-ED	TPMT140308-ED	TPMT1704DD	TPMT1704DD

Insert Assembly		Diameter (mm)						
		Ø60.61-65.00	Ø65.01-66.99	Ø67.00-72.99	Ø73.00-79.99	Ø80.00-86.99	Ø87.00-99.99	Ø100.00-106.99
Insert	Internal	TPMT1704DD	TPMT1704DD	TPMT1704DD	TPMT2405DD	TPMT2405DD	TPMT2405DD	TPMT280716-ED
	Central	TPMT1704DD	TPMT1704DD	TPMT1704DD	TPMT2405DD	TPMT2405DD	TPMT2405DD	TPMT280716-ED
	External	TPMT1704DD	TPMT1704DD	TPMT2405DD	TPMT1704DD	TPMT2405DD	TPMT280716-ED	TPMT2405DD

Recommended Cutting Data

Indexable Deep Hole Drill GD600

Workpiece Materials				HB	Vc Speed (m/min)	Feed (mm/rev)				
						Ø38.00 -39.99	Ø40.00 -51.99	Ø52.00 -63.99	Ø64.00 -84.99	Ø85.00 -106.99
P	Non-alloy steel, cast steel, free cutting steel	0.1-0.25%C	Annealed	125	60-120	0.08-0.15	0.1-0.2	0.13-0.23	0.15-0.25	0.18-0.3
		0.25-0.55%C	Annealed	190	60-120	0.08-0.15	0.1-0.2	0.13-0.23	0.15-0.25	0.18-0.3
		0.25-0.55%C	Quenched and tempered	250	60-120	0.08-0.15	0.1-0.2	0.13-0.23	0.15-0.25	0.18-0.3
		0.55-0.80%C	Annealed	220	60-120	0.08-0.15	0.1-0.2	0.13-0.23	0.15-0.25	0.18-0.3
		0.55-0.80%C	Quenched and tempered	300	60-120	0.08-0.15	0.1-0.2	0.13-0.23	0.15-0.25	0.18-0.3
P	Low alloy steel and cast steel (less than 5% of alloying elements)	Annealed		200	60-100	0.08-0.15	0.1-0.2	0.13-0.23	0.15-0.25	0.18-0.3
		Quenched and tempered		275	60-100	0.08-0.15	0.1-0.2	0.13-0.23	0.15-0.25	0.18-0.3
				300	50-100	0.08-0.15	0.1-0.2	0.13-0.23	0.15-0.25	0.18-0.3
				350	50-100	0.08-0.15	0.1-0.2	0.13-0.23	0.15-0.25	0.18-0.3
P	High alloy steel, cast steel and tool steel	Annealed		200	60-120	0.08-0.15	0.1-0.2	0.13-0.23	0.15-0.25	0.18-0.3
		Quenched and tempered		325	60-120	0.08-0.15	0.1-0.2	0.13-0.23	0.15-0.25	0.18-0.3
M	Stainless steel and cast steel	Ferritic/Martensite		200	60-110	0.08-0.15	0.1-0.2	0.13-0.23	0.15-0.25	0.18-0.3
		Martensite		240	60-110	0.08-0.15	0.1-0.2	0.13-0.23	0.15-0.25	0.18-0.3
		Austenite		180	60-110	0.08-0.15	0.1-0.2	0.13-0.23	0.15-0.25	0.18-0.3
K	Malleable Cast Iron	Ferritic/Martensite		130	60-100	0.08-0.13	0.1-0.15	0.13-0.18	0.15-0.2	0.18-0.23
		Pearlitic		230	60-100	0.08-0.13	0.1-0.15	0.13-0.18	0.15-0.2	0.18-0.23
	Gray Cast Iron(GG)	Ferritic		160	60-100	0.08-0.13	0.1-0.15	0.13-0.18	0.15-0.2	0.18-0.23
		Pearlitic		250	60-100	0.08-0.13	0.1-0.15	0.13-0.18	0.15-0.2	0.18-0.23
Nodular Cast Iron(GGG)	Ferritic		180	60-100	0.08-0.13	0.1-0.15	0.13-0.18	0.15-0.2	0.18-0.23	
	Pearlitic		260	60-100	0.08-0.13	0.1-0.15	0.13-0.18	0.15-0.2	0.18-0.23	

GD602B Series

ZOMR

Deep Hole Drill Inserts

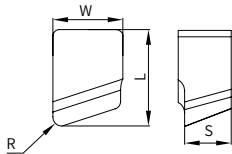

Type	Grade	尺寸 Dimension(mm)				Stock
		S	R	W	L	
ZOMR0502-PA	GN9125	2.2	0.35	4.0	5.0	○
ZOMR0402-PA	GN9125	2.2	0.4	4.1	6.1	○
ZOMR0302-PA	GN9125	2.2	0.4	3.3	4.5	○

● Stock ○ Order

PAD

Guide Pad

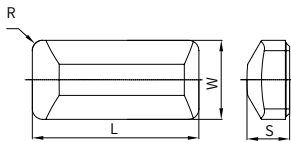

Type	Grade	Dimension(mm)				Stock
		W	S	L	R	
PAD-04080A	GT20A	3.8	2.05	8.00	0.5	○

● Stock ○ Order

GD602B

Deep Hole Drill body

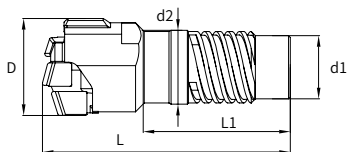

Type	Dimension(mm)				
	D	L	L1	d1	d2
GD602B-XXX.XXSE4	16.08	42.58	25.00	10.80	12.60

Recommended Cutting Data

Indexable Deep Hole Drill GD602A/B

Workpiece Material				HB	Vc Speed(m/ min)	f (mm/rev)		
						Ø8.00-15.59	Ø15.60-19.99	Ø20.00-25.00
P	Non-alloy steel, cast steel, free cutting steel	0.1-0.25%C	Annealed	125	70-120	0.05-0.13	0.08-0.15	0.1-0.17
		0.25-0.55%C	Annealed	190	70-120	0.05-0.13	0.08-0.15	0.1-0.17
		0.25-0.55%C	Quenched and tempered	250	40-70	0.05-0.13	0.08-0.15	0.1-0.17
		0.55-0.80%C	Annealed	220	70-120	0.05-0.13	0.08-0.15	0.1-0.17
		0.55-0.80%C	Quenched and tempered	300	55-100	0.05-0.1	0.08-0.12	0.1-0.15
	Low alloy steel and cast steel(less than 5% of alloying elements)	Annealed	200	70-100	0.05-0.13	0.08-0.15	0.1-0.17	
		Quenched and tempered	275	55-100	0.05-0.1	0.08-0.12	0.1-0.15	
			300	55-100	0.05-0.1	0.08-0.12	0.1-0.15	
			350	55-100	0.05-0.1	0.08-0.12	0.1-0.15	
	High alloy steel, cast steel and tool steel	Annealed	200	50-85	0.05-0.13	0.08-0.15	0.1-0.17	
Quenched and tempered		325	55-100	0.05-0.1	0.08-0.12	0.1-0.15		
M	Stainless steel and cast steel	Ferritic/Martensite	200	60-100	0.05-0.13	0.08-0.15	0.1-0.28	
		Martensite	240	60-100	0.05-0.13	0.08-0.15	0.1-0.28	
		Austenite	180	60-100	0.05-0.12	0.05-0.12	0.08-0.25	
K	Malleable cast iron	Ferritic/Martensite	130	80-100	0.05-0.13	0.08-0.15	0.1-0.17	
		Pearlitic	230	80-100	0.05-0.13	0.08-0.15	0.1-0.17	
	Gray cast iron(GG)	Ferritic	160	60-100	0.05-0.13	0.06-0.13	0.08-0.18	
		Pearlitic	250	60-100	0.05-0.13	0.06-0.13	0.08-0.18	
	Cast iron nodular(GGG)	Ferritic	180	50-100	0.05-0.13	0.06-0.13	0.08-0.18	
		Pearlitic	260	50-100	0.05-0.13	0.06-0.13	0.08-0.18	

Indexable Drill Body Identification System

GHD - 200 - 3D - FC 25 - Q 06 A



① Tool type	
GHD	Indexable drill

② Dia of drill	
Range	Φ14-Φ51

③ Aspect Ratio	
2D/3D/4D/5D	

④ Shank type	
FC	Flange-Flat
FW	Flange-Weldone
FH	Flange-Whistle

⑤ Shank size	
Φ20 Φ25	
Φ32 Φ40	

⑥ Insert shape	
Q	

⑦ Cutting edge length	
04、05、06、07 09、11、13、15	

⑧ Drill type	
A	General
D	Customer-made

QPMG Drilling Inserts

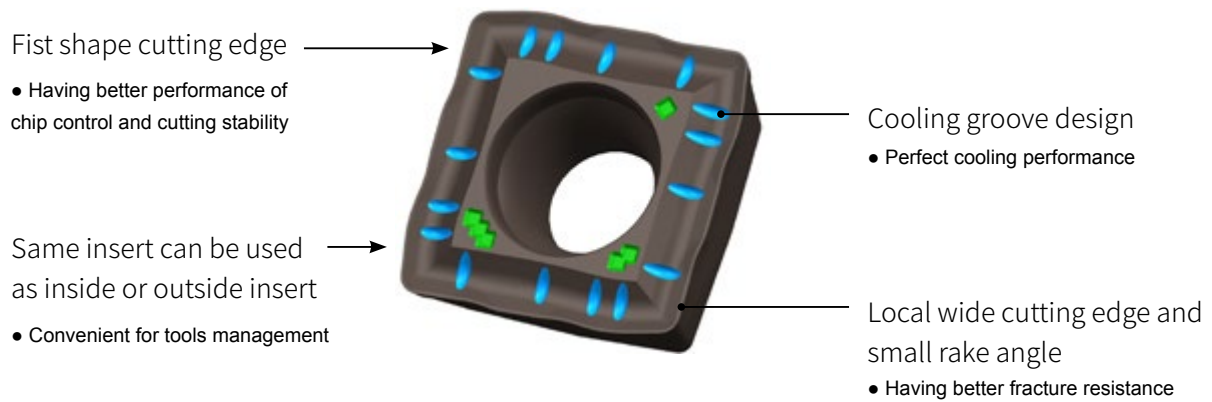

GHD Drill Body

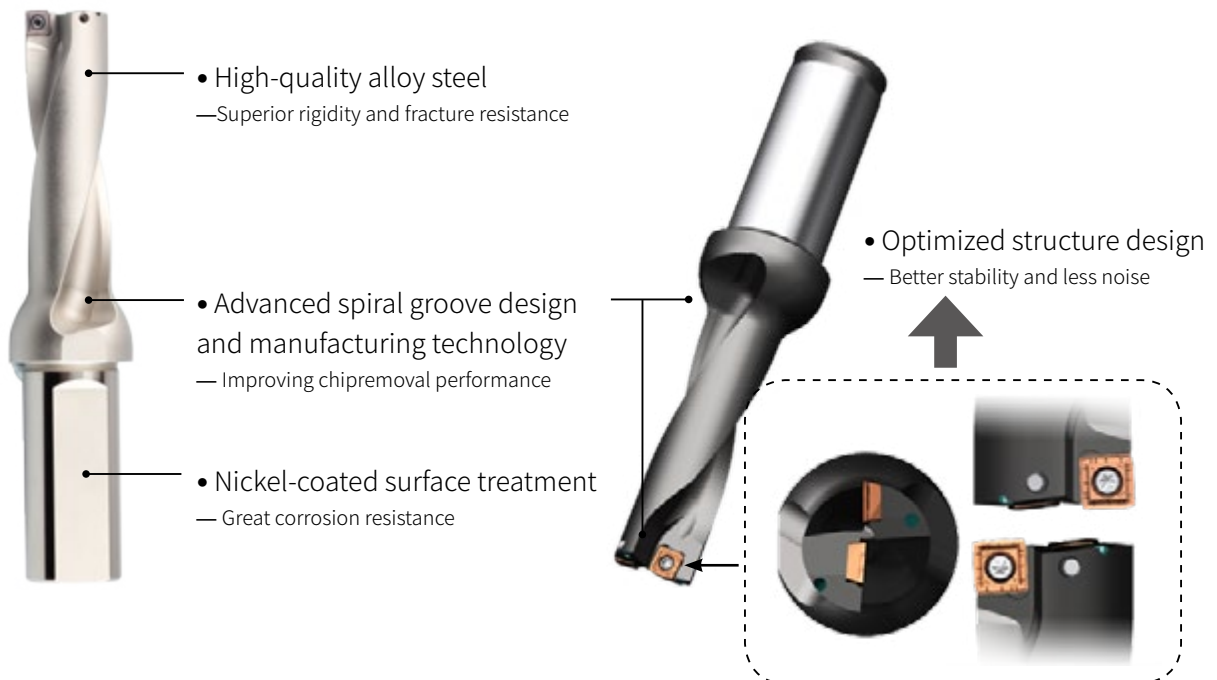

GHD-2D

Indexable Drill (Patented)

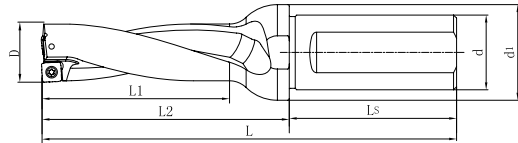

Dia.	Drilling body	Dimension							Insert
		D	d	d1	Ls	L2	L1	L	
Φ14.0	GHD-140-2D-FC20-Q04A	14.0	20	25	50	46	30	96	QPMG040204
Φ14.5	GHD-145-2D-FC20-Q04A	14.5	20	25	50	46	30	96	
Φ15.0	GHD-150-2D-FC20-Q04A	15.0	20	25	50	48	32	98	
Φ15.5	GHD-155-2D-FC20-Q04A	15.5	20	25	50	48	32	98	
Φ16.0	GHD-160-2D-FC20-Q05A	16.0	20	25	50	50	34	100	QPMG050204
Φ16.5	GHD-165-2D-FC20-Q05A	16.5	20	25	50	50	34	100	
Φ17.0	GHD-170-2D-FC25-Q05A	17.0	25	32	56	57	37	113	
Φ17.5	GHD-175-2D-FC25-Q05A	17.5	25	32	56	57	37	113	
Φ18.0	GHD-180-2D-FC25-Q05A	18.0	25	32	56	59	39	115	QPMG060204
Φ18.5	GHD-185-2D-FC25-Q05A	18.5	25	32	56	59	39	115	
Φ19.0	GHD-190-2D-FC25-Q06A	19.0	25	32	56	61	41	117	
Φ19.5	GHD-195-2D-FC25-Q06A	19.5	25	32	56	61	41	117	
Φ20.0	GHD-200-2D-FC25-Q06A	20.0	25	32	56	63	43	119	QPMG07T306
Φ20.5	GHD-205-2D-FC25-Q06A	20.5	25	32	56	63	43	119	
Φ21.0	GHD-210-2D-FC25-Q06A	21.0	25	32	56	65	45	121	
Φ21.5	GHD-215-2D-FC25-Q06A	21.5	25	32	56	65	45	121	
Φ22.0	GHD-220-2D-FC25-Q06A	22.0	25	32	56	67	47	123	QPMG07T306
Φ22.5	GHD-225-2D-FC25-Q06A	22.5	25	32	56	67	47	123	
Φ23.0	GHD-230-2D-FC25-Q07A	23.0	25	32	56	69	49	125	
Φ23.5	GHD-235-2D-FC25-Q07A	23.5	25	32	56	69	49	125	
Φ24.0	GHD-240-2D-FC25-Q07A	24.0	25	32	56	71	51	127	QPMG07T306
Φ24.5	GHD-245-2D-FC25-Q07A	24.5	25	32	56	71	51	127	
Φ25.0	GHD-250-2D-FC25-Q07A	25.0	25	32	56	73	53	129	
Φ25.5	GHD-255-2D-FC32-Q07A	25.5	32	42	60	81	56	141	
Φ26.0	GHD-260-2D-FC32-Q07A	26.0	32	42	60	81	56	141	QPMG07T306
Φ26.5	GHD-265-2D-FC32-Q07A	26.5	32	42	60	81	56	141	
Φ27.0	GHD-270-2D-FC32-Q07A	27.0	32	42	60	83	58	143	

GHD-2D

Indexable Drill (Patented)

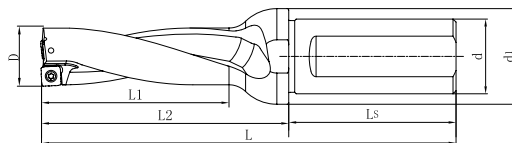

Dia.	Drilling body	Dimension							Insert
		D	d	d1	Ls	L2	L1	L	
Φ27.5	GHD-275-2D-FC32-Q09A	27.5	32	42	60	83	58	143	QPMG09T308
Φ28.0	GHD-280-2D-FC32-Q09A	28.0	32	42	60	85	60	145	
Φ28.5	GHD-285-2D-FC32-Q09A	28.5	32	42	60	85	60	145	
Φ29.0	GHD-290-2D-FC32-Q09A	29.0	32	42	60	87	62	147	
Φ29.5	GHD-295-2D-FC32-Q09A	29.5	32	42	60	87	62	147	
Φ30.0	GHD-300-2D-FC32-Q09A	30.0	32	42	60	89	64	149	
Φ30.5	GHD-305-2D-FC32-Q09A	30.5	32	42	60	89	64	149	
Φ31.0	GHD-310-2D-FC32-Q09A	31.0	32	42	60	91	66	151	
Φ31.5	GHD-315-2D-FC32-Q09A	31.5	32	42	60	91	66	151	
Φ32.0	GHD-320-2D-FC32-Q09A	32.0	32	42	60	93	68	153	
Φ32.5	GHD-325-2D-FC32-Q09A	32.5	32	48	60	93	68	153	
Φ33.0	GHD-330-2D-FC40-Q09A	33.0	40	48	70	100	70	170	
Φ33.5	GHD-335-2D-FC40-Q11A	33.5	40	48	70	100	70	170	
Φ34.0	GHD-340-2D-FC40-Q11A	34.0	40	48	70	103	73	173	
Φ34.5	GHD-345-2D-FC40-Q11A	34.5	40	48	70	103	73	173	
Φ35.0	GHD-350-2D-FC40-Q11A	35.0	40	48	70	105	75	175	
Φ35.5	GHD-355-2D-FC40-Q11A	35.5	40	48	70	105	75	175	
Φ36.0	GHD-360-2D-FC40-Q11A	36.0	40	48	70	107	77	177	
Φ36.5	GHD-365-2D-FC40-Q11A	36.5	40	48	70	107	77	177	
Φ37.0	GHD-370-2D-FC40-Q11A	37.0	40	48	70	109	79	179	
Φ37.5	GHD-375-2D-FC40-Q11A	37.5	40	48	70	109	79	179	
Φ38.0	GHD-380-2D-FC40-Q11A	38.0	40	48	70	111	81	181	
Φ38.5	GHD-385-2D-FC40-Q11A	38.5	40	48	70	111	81	181	
Φ39.0	GHD-390-2D-FC40-Q11A	39.0	40	48	70	113	83	183	
Φ39.5	GHD-395-2D-FC40-Q11A	39.5	40	48	70	113	83	183	
Φ40.0	GHD-400-2D-FC40-Q11A	40.0	40	48	70	116	86	186	

GHD-2D

Indexable Drill (Patented)

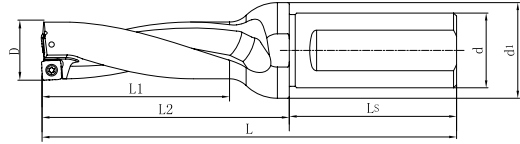

Dia.	Drilling body	Dimension							Insert	
		D	d	d1	Ls	L2	L1	L		
Φ40.5	GHD-405-2D-FC40-Q13A	40.5	40	48	70	116	86	186	QPMG130408	
Φ41.0	GHD-410-2D-FC40-Q13A	41.0	40	48	70	118	88	188		
Φ41.5	GHD-415-2D-FC40-Q13A	41.5	40	48	70	118	88	188		
Φ42.0	GHD-420-2D-FC40-Q13A	42.0	40	48	70	120	90	190		
Φ42.5	GHD-425-2D-FC40-Q13A	42.5	40	48	70	120	90	190		
Φ43.0	GHD-430-2D-FC40-Q13A	43.0	40	48	70	122	92	192		
Φ43.5	GHD-435-2D-FC40-Q13A	43.5	40	48	70	122	92	192		
Φ44.0	GHD-440-2D-FC40-Q13A	44.0	40	48	70	124	94	194		
Φ44.5	GHD-445-2D-FC40-Q13A	44.5	40	48	70	124	94	194		
Φ45.0	GHD-450-2D-FC40-Q13A	45.0	40	48	70	126	96	196		
Φ45.5	GHD-455-2D-FC40-Q15A	45.5	40	48	70	126	96	196		QPMG150512
Φ46.0	GHD-460-2D-FC40-Q15A	46.0	40	48	70	128	98	198		
Φ46.5	GHD-465-2D-FC40-Q15A	46.5	40	48	70	128	98	198		
Φ47.0	GHD-470-2D-FC40-Q15A	47.0	40	48	70	130	100	200		
Φ47.5	GHD-475-2D-FC40-Q15A	47.5	40	48	70	130	100	200		
Φ48.0	GHD-480-2D-FC40-Q15A	48.0	40	48	70	132	102	202		
Φ48.5	GHD-485-2D-FC40-Q15A	48.5	40	48	70	132	102	202		
Φ49.0	GHD-490-2D-FC40-Q15A	49.0	40	49	70	134	104	204		
Φ49.5	GHD-495-2D-FC40-Q15A	49.5	40	49	70	134	104	204		
Φ50.0	GHD-500-2D-FC40-Q15A	50.0	40	50	70	136	106	206		
Φ50.5	GHD-505-2D-FC40-Q15A	50.5	40	50	70	136	106	206		
Φ51.0	GHD-510-2D-FC40-Q15A	51.0	40	51	70	138	108	208		

GHD-3D

Indexable Drill (Patented)

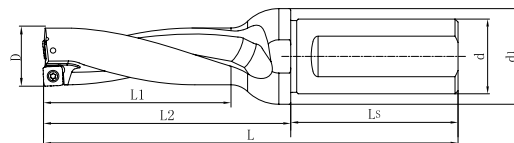

Dia.	Drilling body	Dimension							Insert
		D	d	d1	Ls	L2	L1	L	
Φ14.0	GHD-140-3D-FC20-Q04A	14.0	20	25	50	60	44	110	QPMG040204
Φ14.5	GHD-145-3D-FC20-Q04A	14.5	20	25	50	60	44	110	
Φ15.0	GHD-150-3D-FC20-Q04A	15.0	20	25	50	63	47	113	
Φ15.5	GHD-155-3D-FC20-Q04A	15.5	20	25	50	63	47	113	QPMG050204
Φ16.0	GHD-160-3D-FC20-Q05A	16.0	20	25	50	66	50	116	
Φ16.5	GHD-165-3D-FC20-Q05A	16.5	20	25	50	66	50	116	
Φ17.0	GHD-170-3D-FC25-Q05A	17.0	25	32	56	74	54	130	QPMG050204
Φ17.5	GHD-175-3D-FC25-Q05A	17.5	25	32	56	74	54	130	
Φ18.0	GHD-180-3D-FC25-Q05A	18.0	25	32	56	77	57	133	
Φ18.5	GHD-185-3D-FC25-Q05A	18.5	25	32	56	77	57	133	QPMG060204
Φ19.0	GHD-190-3D-FC25-Q06A	19.0	25	32	56	80	60	136	
Φ19.5	GHD-195-3D-FC25-Q06A	19.5	25	32	56	80	60	136	
Φ20.0	GHD-200-3D-FC25-Q06A	20.0	25	32	56	83	63	139	QPMG060204
Φ20.5	GHD-205-3D-FC25-Q06A	20.5	25	32	56	83	63	139	
Φ21.0	GHD-210-3D-FC25-Q06A	21.0	25	32	56	86	66	142	
Φ21.5	GHD-215-3D-FC25-Q06A	21.5	25	32	56	86	66	142	QPMG07T306
Φ22.0	GHD-220-3D-FC25-Q06A	22.0	25	32	56	89	69	145	
Φ22.5	GHD-225-3D-FC25-Q06A	22.5	25	32	56	89	69	145	
Φ23.0	GHD-230-3D-FC25-Q07A	23.0	25	32	56	92	72	148	QPMG07T306
Φ23.5	GHD-235-3D-FC25-Q07A	23.5	25	32	56	92	72	148	
Φ24.0	GHD-240-3D-FC25-Q07A	24.0	25	32	56	95	75	151	
Φ24.5	GHD-245-3D-FC25-Q07A	24.5	25	32	56	95	75	151	QPMG07T306
Φ25.0	GHD-250-3D-FC25-Q07A	25.0	25	32	56	98	78	154	
Φ25.5	GHD-255-3D-FC32-Q07A	25.5	32	42	60	107	82	167	
Φ26.0	GHD-260-3D-FC32-Q07A	26.0	32	42	60	107	82	167	QPMG07T306
Φ26.5	GHD-265-3D-FC32-Q07A	26.5	32	42	60	107	82	167	
Φ27.0	GHD-270-3D-FC32-Q07A	27.0	32	42	60	110	85	170	

GHD-3D

Indexable Drill (Patented)

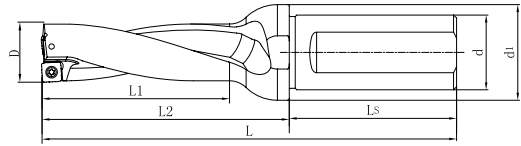

Dia.	Drilling body	Dimension							Insert	
		D	d	d1	Ls	L2	L1	L		
Φ27.5	GHD-275-3D-FC32-Q09A	27.5	32	42	60	110	85	170	QPMG09T308	
Φ28.0	GHD-280-3D-FC32-Q09A	28.0	32	42	60	113	88	173		
Φ28.5	GHD-285-3D-FC32-Q09A	28.5	32	42	60	113	88	173		
Φ29.0	GHD-290-3D-FC32-Q09A	29.0	32	42	60	116	91	176		
Φ29.5	GHD-295-3D-FC32-Q09A	29.5	32	42	60	116	91	176		
Φ30.0	GHD-300-3D-FC32-Q09A	30.0	32	42	60	119	94	179		
Φ30.5	GHD-305-3D-FC32-Q09A	30.5	32	42	60	119	94	179		
Φ31.0	GHD-310-3D-FC32-Q09A	31.0	32	42	60	122	97	182		
Φ31.5	GHD-315-3D-FC32-Q09A	31.5	32	42	60	124	97	182		
Φ32.0	GHD-320-3D-FC32-Q09A	32.0	32	42	60	125	100	185		
Φ32.5	GHD-325-3D-FC32-Q09A	32.5	32	42	60	125	100	185		
Φ33.0	GHD-330-3D-FC40-Q09A	33.0	40	48	70	133	103	203		QPMG110408
Φ33.5	GHD-335-3D-FC40-Q11A	33.5	40	48	70	133	103	203		
Φ34.0	GHD-340-3D-FC40-Q11A	34.0	40	48	70	137	107	207		
Φ34.5	GHD-345-3D-FC40-Q11A	34.5	40	48	70	137	107	207		
Φ35.0	GHD-350-3D-FC40-Q11A	35.0	40	48	70	140	110	210		
Φ35.5	GHD-355-3D-FC40-Q11A	35.5	40	48	70	140	110	210		
Φ36.0	GHD-360-3D-FC40-Q11A	36.0	40	48	70	143	113	213		
Φ36.5	GHD-365-3D-FC40-Q11A	36.5	40	48	70	143	113	213		
Φ37.0	GHD-370-3D-FC40-Q11A	37.0	40	48	70	146	116	216		
Φ37.5	GHD-375-3D-FC40-Q11A	37.5	40	48	70	146	116	216		
Φ38.0	GHD-380-3D-FC40-Q11A	38.0	40	48	70	149	119	219		
Φ38.5	GHD-385-3D-FC40-Q11A	38.5	40	48	70	149	119	219		
Φ39.0	GHD-390-3D-FC40-Q11A	39.0	40	48	70	152	122	222		
Φ39.5	GHD-395-3D-FC40-Q11A	39.5	40	48	70	152	122	222		
Φ40.0	GHD-400-3D-FC40-Q11A	40.0	40	48	70	156	126	226		

GHD-3D

Indexable Drill (Patented)

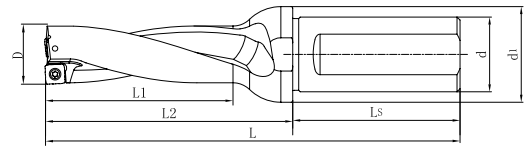

Dia.	Drilling body	Dimension							Insert	
		D	d	d1	Ls	L2	L1	L		
Φ40.5	GHD-405-3D-FC40-Q13A	40.5	40	48	70	156	126	226	QPMG130408	
Φ41.0	GHD-410-3D-FC40-Q13A	41.0	40	48	70	159	129	229		
Φ41.5	GHD-415-3D-FC40-Q13A	41.5	40	48	70	159	129	229		
Φ42.0	GHD-420-3D-FC40-Q13A	42.0	40	48	70	162	132	232		
Φ42.5	GHD-425-3D-FC40-Q13A	42.5	40	48	70	162	132	232		
Φ43.0	GHD-430-3D-FC40-Q13A	43.0	40	48	70	165	135	235		
Φ43.5	GHD-435-3D-FC40-Q13A	43.5	40	48	70	165	135	235		
Φ44.0	GHD-440-3D-FC40-Q13A	44.0	40	48	70	168	138	238		
Φ44.5	GHD-445-3D-FC40-Q13A	44.5	40	48	70	168	138	238		
Φ45.0	GHD-450-3D-FC40-Q13A	45.0	40	48	70	171	141	241		
Φ45.5	GHD-455-3D-FC40-Q15A	45.5	40	48	70	171	141	241		QPMG150512
Φ46.0	GHD-460-3D-FC40-Q15A	46.0	40	48	70	174	144	244		
Φ46.5	GHD-465-3D-FC40-Q15A	46.5	40	48	70	174	144	244		
Φ47.0	GHD-470-3D-FC40-Q15A	47.0	40	48	70	177	147	247		
Φ47.5	GHD-475-3D-FC40-Q15A	47.5	40	48	70	177	147	247		
Φ48.0	GHD-480-3D-FC40-Q15A	48.0	40	48	70	180	150	250		
Φ48.5	GHD-485-3D-FC40-Q15A	48.5	40	48	70	180	150	250		
Φ49.0	GHD-490-3D-FC40-Q15A	49.0	40	49	70	183	153	253		
Φ49.5	GHD-495-3D-FC40-Q15A	49.5	40	49	70	183	153	253		
Φ50.0	GHD-500-3D-FC40-Q15A	50.0	40	50	70	186	156	256		
Φ50.5	GHD-505-3D-FC40-Q15A	50.5	40	50	70	186	156	256		
Φ51.0	GHD-510-3D-FC40-Q15A	51.0	40	51	70	189	159	259		

GHD-4D

Indexable Drill (Patented)

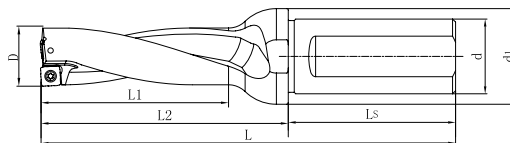

Dia.	Drilling body	Dimension							Insert
		D	d	d1	Ls	L2	L1	L	
Φ14.0	GHD-140-4D-FC20-Q04A	14.0	20	25	50	74	58	124	QPMG040204
Φ14.5	GHD-145-4D-FC20-Q04A	14.5	20	25	50	74	58	124	
Φ15.0	GHD-150-4D-FC20-Q04A	15.0	20	25	50	78	62	128	
Φ15.5	GHD-155-4D-FC20-Q04A	15.5	20	25	50	78	62	128	
Φ16.0	GHD-160-4D-FC20-Q05A	16.0	20	25	50	82	66	132	QPMG050204
Φ16.5	GHD-165-4D-FC20-Q05A	16.5	20	25	50	82	66	132	
Φ17.0	GHD-170-4D-FC25-Q05A	17.0	25	32	56	91	71	147	
Φ17.5	GHD-175-4D-FC25-Q05A	17.5	25	32	56	91	71	147	
Φ18.0	GHD-180-4D-FC25-Q05A	18.0	25	32	56	95	75	151	QPMG060204
Φ18.5	GHD-185-4D-FC25-Q05A	18.5	25	32	56	95	75	151	
Φ19.0	GHD-190-4D-FC25-Q06A	19.0	25	32	56	99	79	155	
Φ19.5	GHD-195-4D-FC25-Q06A	19.5	25	32	56	99	79	155	
Φ20.0	GHD-200-4D-FC25-Q06A	20.0	25	32	56	103	83	159	QPMG07T306
Φ20.5	GHD-205-4D-FC25-Q06A	20.5	25	32	56	103	83	159	
Φ21.0	GHD-210-4D-FC25-Q06A	21.0	25	32	56	107	87	163	
Φ21.5	GHD-215-4D-FC25-Q06A	21.5	25	32	56	107	87	163	
Φ22.0	GHD-220-4D-FC25-Q06A	22.0	25	32	56	111	91	167	QPMG07T306
Φ22.5	GHD-225-4D-FC25-Q06A	22.5	25	32	56	111	91	167	
Φ23.0	GHD-230-4D-FC25-Q07A	23.0	25	32	56	115	95	171	
Φ23.5	GHD-235-4D-FC25-Q07A	23.5	25	32	56	115	95	171	
Φ24.0	GHD-240-4D-FC25-Q07A	24.0	25	32	56	119	99	175	QPMG07T306
Φ24.5	GHD-245-4D-FC25-Q07A	24.5	25	32	56	119	99	175	
Φ25.0	GHD-250-4D-FC25-Q07A	25.0	25	32	56	123	103	179	
Φ25.5	GHD-255-4D-FC32-Q07A	25.5	32	42	60	133	108	193	
Φ26.0	GHD-260-4D-FC32-Q07A	26.0	32	42	60	133	108	193	QPMG07T306
Φ26.5	GHD-265-4D-FC32-Q07A	26.5	32	42	60	133	108	193	
Φ27.0	GHD-270-4D-FC32-Q07A	27.0	32	42	60	137	112	197	

GHD-4D

Indexable Drill (Patented)

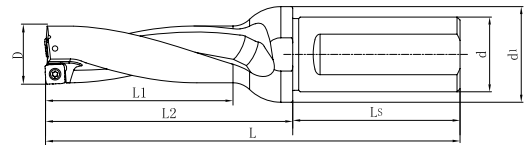

Dia.	Drilling body	Dimension							Insert
		D	d	d1	Ls	L2	L1	L	
Φ27.5	GHD-275-4D-FC32-Q09A	27.5	32	42	60	137	112	197	QPMG09T308
Φ28.0	GHD-280-4D-FC32-Q09A	28.0	32	42	60	141	116	201	
Φ28.5	GHD-285-4D-FC32-Q09A	28.5	32	42	60	141	116	201	
Φ29.0	GHD-290-4D-FC32-Q09A	29.0	32	42	60	145	120	205	
Φ29.5	GHD-295-4D-FC32-Q09A	29.5	32	42	60	145	120	205	
Φ30.0	GHD-300-4D-FC32-Q09A	30.0	32	42	60	149	124	209	
Φ30.5	GHD-305-4D-FC32-Q09A	30.5	32	42	60	149	124	209	
Φ31.0	GHD-310-4D-FC32-Q09A	31.0	32	42	60	153	128	213	
Φ31.5	GHD-315-4D-FC32-Q09A	31.5	32	42	60	153	128	213	
Φ32.0	GHD-320-4D-FC32-Q09A	32.0	32	42	60	157	132	217	
Φ32.5	GHD-325-4D-FC32-Q09A	32.5	32	42	60	157	132	217	
Φ33.0	GHD-330-4D-FC40-Q09A	33.0	40	48	70	166	136	236	
Φ33.5	GHD-335-4D-FC40-Q11A	33.5	40	48	70	166	136	236	
Φ34.0	GHD-340-4D-FC40-Q11A	34.0	40	48	70	171	141	241	
Φ34.5	GHD-345-4D-FC40-Q11A	34.5	40	48	70	171	141	241	
Φ35.0	GHD-350-4D-FC40-Q11A	35.0	40	48	70	175	145	245	
Φ35.5	GHD-355-4D-FC40-Q11A	35.5	40	48	70	175	145	245	
Φ36.0	GHD-360-4D-FC40-Q11A	36.0	40	48	70	179	149	249	
Φ36.5	GHD-365-4D-FC40-Q11A	36.5	40	48	70	179	149	249	
Φ37.0	GHD-370-4D-FC40-Q11A	37.0	40	48	70	183	153	253	
Φ37.5	GHD-375-4D-FC40-Q11A	37.5	40	48	70	183	153	253	
Φ38.0	GHD-380-4D-FC40-Q11A	38.0	40	48	70	187	157	257	
Φ38.5	GHD-385-4D-FC40-Q11A	38.5	40	48	70	187	157	257	
Φ39.0	GHD-390-4D-FC40-Q11A	39.0	40	48	70	191	161	261	
Φ39.5	GHD-395-4D-FC40-Q11A	39.5	40	48	70	191	161	261	
Φ40.0	GHD-400-4D-FC40-Q11A	40.0	40	48	70	196	166	266	

QPMG09T308

QPMG110408

GHD-4D

Indexable Drill (Patented)

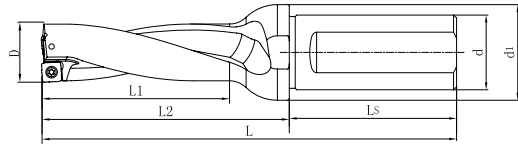

Dia.	Drilling body	Dimension							Insert	
		D	d	d1	Ls	L2	L1	L		
Φ40.5	GHD-405-4D-FC40-Q13A	40.5	40	48	70	196	166	266	QPMG130408	
Φ41.0	GHD-410-4D-FC40-Q13A	41.0	40	48	70	200	170	270		
Φ41.5	GHD-415-4D-FC40-Q13A	41.5	40	48	70	200	170	270		
Φ42.0	GHD-420-4D-FC40-Q13A	42.0	40	48	70	204	174	274		
Φ42.5	GHD-425-4D-FC40-Q13A	42.5	40	48	70	204	174	274		
Φ43.0	GHD-430-4D-FC40-Q13A	43.0	40	48	70	208	178	278		
Φ43.5	GHD-435-4D-FC40-Q13A	43.5	40	48	70	208	178	278		
Φ44.0	GHD-440-4D-FC40-Q13A	44.0	40	48	70	212	182	282		
Φ44.5	GHD-445-4D-FC40-Q13A	44.5	40	48	70	212	182	282		
Φ45.0	GHD-450-4D-FC40-Q13A	45.0	40	48	70	216	186	286		
Φ45.5	GHD-455-4D-FC40-Q15A	45.5	40	48	70	216	186	286		QPMG150512
Φ46.0	GHD-460-4D-FC40-Q15A	46.0	40	48	70	220	190	290		
Φ46.5	GHD-465-4D-FC40-Q15A	46.5	40	48	70	220	190	290		
Φ47.0	GHD-470-4D-FC40-Q15A	47.0	40	48	70	224	194	294		
Φ47.5	GHD-475-4D-FC40-Q15A	47.5	40	48	70	224	194	294		
Φ48.0	GHD-480-4D-FC40-Q15A	48.0	40	48	70	228	198	298		
Φ48.5	GHD-485-4D-FC40-Q15A	48.5	40	48	70	228	198	298		
Φ49.0	GHD-490-4D-FC40-Q15A	49.0	40	49	70	232	202	302		
Φ49.5	GHD-495-4D-FC40-Q15A	49.5	40	49	70	232	202	302		
Φ50.0	GHD-500-4D-FC40-Q15A	50.0	40	50	70	236	206	306		
Φ50.5	GHD-505-4D-FC40-Q15A	50.5	40	50	70	236	206	306		
Φ51.0	GHD-510-4D-FC40-Q15A	51.0	40	51	70	240	210	310		

GHD-5D

Indexable Drill (Patented)

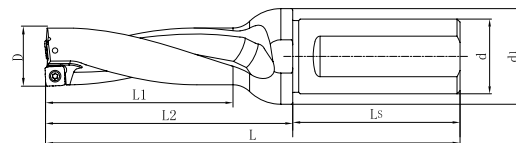

Dia.	Drilling body	Dimension							Insert
		D	d	d1	Ls	L2	L1	L	
Φ14.0	GHD-140-5D-FC20-Q04A	14.0	20	25	50	88	72	138	QPMG040204
Φ14.5	GHD-145-5D-FC20-Q04A	14.5	20	25	50	88	72	138	
Φ15.0	GHD-150-5D-FC20-Q04A	15.0	20	25	50	93	77	143	
Φ15.5	GHD-155-5D-FC25-Q04A	15.5	25	32	56	102	82	158	
Φ16.0	GHD-160-5D-FC25-Q05A	16.0	25	32	56	102	82	158	QPMG050204
Φ16.5	GHD-165-5D-FC25-Q05A	16.5	25	32	56	102	82	158	
Φ17.0	GHD-170-5D-FC25-Q05A	17.0	25	32	56	108	87	164	
Φ17.5	GHD-175-5D-FC25-Q05A	17.5	25	32	56	108	87	164	
Φ18.0	GHD-180-5D-FC25-Q05A	18.0	25	32	56	113	93	169	QPMG060204
Φ18.5	GHD-185-5D-FC25-Q05A	18.5	25	32	56	113	93	169	
Φ19.0	GHD-190-5D-FC25-Q06A	19.0	25	32	56	118	98	174	
Φ19.5	GHD-195-5D-FC25-Q06A	19.5	25	32	56	118	98	174	
Φ20.0	GHD-200-5D-FC25-Q06A	20.0	25	32	56	123	103	179	QPMG07T306
Φ20.5	GHD-205-5D-FC25-Q06A	20.5	25	32	56	123	103	179	
Φ21.0	GHD-210-5D-FC25-Q06A	21.0	25	32	56	128	108	184	
Φ21.5	GHD-215-5D-FC25-Q06A	21.5	25	32	56	128	108	184	
Φ22.0	GHD-220-5D-FC25-Q06A	22.0	25	32	56	133	113	189	QPMG07T306
Φ22.5	GHD-225-5D-FC25-Q06A	22.5	25	32	56	133	113	189	
Φ23.0	GHD-230-5D-FC32-Q07A	23.0	32	42	56	143	118	203	
Φ23.5	GHD-235-5D-FC32-Q07A	23.5	32	42	56	143	118	203	
Φ24.0	GHD-240-5D-FC32-Q07A	24.0	32	42	56	148	123	208	QPMG07T306
Φ24.5	GHD-245-5D-FC32-Q07A	24.5	32	42	56	148	123	208	
Φ25.0	GHD-250-5D-FC32-Q07A	25.0	32	42	56	153	128	213	
Φ25.5	GHD-255-5D-FC32-Q07A	25.5	32	42	56	153	128	213	
Φ26.0	GHD-260-5D-FC32-Q07A	26.0	32	42	60	159	134	219	QPMG07T306
Φ26.5	GHD-265-5D-FC32-Q07A	26.5	32	42	60	159	134	219	
Φ27.0	GHD-270-5D-FC32-Q07A	27.0	32	42	60	164	139	224	

GHD-5D

Indexable Drill (Patented)

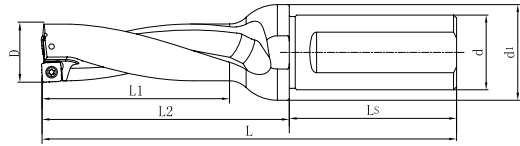

Dia.	Drilling body	Dimension							Insert
		D	d	d1	Ls	L2	L1	L	
Φ27.5	GHD-275-5D-FC32-Q09A	27.5	32	42	60	164	139	224	QPMG09T308
Φ28.0	GHD-280-5D-FC32-Q09A	28.0	32	42	60	169	144	229	
Φ28.5	GHD-285-5D-FC32-Q09A	28.5	32	42	60	169	144	229	
Φ29.0	GHD-290-5D-FC32-Q09A	29.0	32	42	60	174	149	234	
Φ29.5	GHD-295-5D-FC32-Q09A	29.5	32	42	60	174	149	234	
Φ30.0	GHD-300-5D-FC32-Q09A	30.0	32	42	60	179	154	239	
Φ30.5	GHD-305-5D-FC32-Q09A	30.5	32	42	60	179	154	239	
Φ31.0	GHD-310-5D-FC32-Q09A	31.0	32	42	60	184	159	244	
Φ31.5	GHD-315-5D-FC32-Q09A	31.5	32	42	60	184	159	244	
Φ32.0	GHD-320-5D-FC32-Q09A	32.0	32	42	60	194	164	254	
Φ32.5	GHD-325-5D-FC40-Q09A	32.5	40	48	60	199	169	269	
Φ33.0	GHD-330-5D-FC40-Q09A	33.0	40	48	60	199	169	269	
Φ33.5	GHD-335-5D-FC40-Q11A	33.5	40	48	70	199	169	269	
Φ34.0	GHD-340-5D-FC40-Q11A	34.0	40	48	70	205	175	275	
Φ34.5	GHD-345-5D-FC40-Q11A	34.5	40	48	70	205	175	275	
Φ35.0	GHD-350-5D-FC40-Q11A	35.0	40	48	70	210	180	280	
Φ35.5	GHD-355-5D-FC40-Q11A	35.5	40	48	70	210	180	280	
Φ36.0	GHD-360-5D-FC40-Q11A	36.0	40	48	70	215	185	285	
Φ36.5	GHD-365-5D-FC40-Q11A	36.5	40	48	70	215	185	285	
Φ37.0	GHD-370-5D-FC40-Q11A	37.0	40	48	70	220	190	290	
Φ37.5	GHD-375-5D-FC40-Q11A	37.5	40	48	70	220	190	290	
Φ38.0	GHD-380-5D-FC40-Q11A	38.0	40	48	70	225	195	295	
Φ38.5	GHD-385-5D-FC40-Q11A	38.5	40	48	70	225	195	295	
Φ39.0	GHD-390-5D-FC40-Q11A	39.0	40	48	70	230	200	300	
Φ39.5	GHD-395-5D-FC40-Q11A	39.5	40	48	70	230	200	300	
Φ40.0	GHD-400-5D-FC40-Q11A	40.0	40	48	70	236	206	306	

QPMG09T308

QPMG110408

GHD-5D

Indexable Drill (Patented)

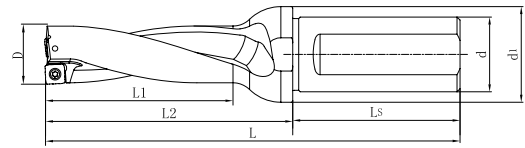

Dia.	Drilling body	Dimension							Insert	
		D	d	d1	Ls	L2	L1	L		
Φ40.5	GHD-405-5D-FC40-Q13A	40.5	40	48	70	236	206	306	QPMG130408	
Φ41.0	GHD-410-5D-FC40-Q13A	41.0	40	48	70	241	211	311		
Φ41.5	GHD-415-5D-FC40-Q13A	41.5	40	48	70	241	211	311		
Φ42.0	GHD-420-5D-FC40-Q13A	42.0	40	48	70	246	216	316		
Φ42.5	GHD-425-5D-FC40-Q13A	42.5	40	48	70	246	216	316		
Φ43.0	GHD-430-5D-FC40-Q13A	43.0	40	48	70	251	221	321		
Φ43.5	GHD-435-5D-FC40-Q13A	43.5	40	48	70	251	221	321		
Φ44.0	GHD-440-5D-FC40-Q13A	44.0	40	48	70	256	226	326		
Φ44.5	GHD-445-5D-FC40-Q13A	44.5	40	48	70	256	226	326		
Φ45.0	GHD-450-5D-FC40-Q13A	45.0	40	48	70	261	231	331		
Φ45.5	GHD-455-5D-FC40-Q15A	45.5	40	48	70	261	231	331		QPMG150512
Φ46.0	GHD-460-5D-FC40-Q15A	46.0	40	48	70	266	236	336		
Φ46.5	GHD-465-5D-FC40-Q15A	46.5	40	48	70	266	236	336		
Φ47.0	GHD-470-5D-FC40-Q15A	47.0	40	48	70	271	241	341		
Φ47.5	GHD-475-5D-FC40-Q15A	47.5	40	48	70	271	241	341		
Φ48.0	GHD-480-5D-FC40-Q15A	48.0	40	48	70	276	246	346		
Φ48.5	GHD-485-5D-FC40-Q15A	48.5	40	48	70	276	246	346		
Φ49.0	GHD-490-5D-FC40-Q15A	49.0	40	49	70	281	251	351		
Φ49.5	GHD-495-5D-FC40-Q15A	49.5	40	49	70	281	251	351		
Φ50.0	GHD-500-5D-FC40-Q15A	50.0	40	50	70	286	256	356		
Φ50.5	GHD-505-5D-FC40-Q15A	50.5	40	50	70	286	256	356		
Φ51.0	GHD-510-5D-FC40-Q15A	51.0	40	51	70	291	261	361		

QPMG

Indexable Drill Insert (Patented)

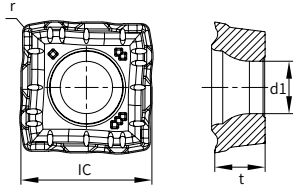

Type	Grade		Dimension				Dia. of Drill
	GA4230	GS4130	IC	t	r	d1	
QPMG040204-DP	●	●	4.7	2.3	0.4	2.2	Φ14.0 ~ Φ15.9
QPMG050204-DP	●	●	5.7	2.5	0.4	2.6	Φ16.0 ~ Φ18.9
QPMG060204-DP	●	●	6.5	2.5	0.4	2.6	Φ19.0 ~ Φ22.5
QPMG07T306-DP	●	●	7.94	3.5	0.6	2.85	Φ22.6 ~ Φ27.0
QPMG09T308-DP	●	●	9.7	3.97	0.8	3.5	Φ27.1 ~ Φ33.0
QPMG110408-DP	●	●	11.5	4.76	0.8	4.4	Φ33.1 ~ Φ40.0
QPMG130408-DP	●	●	13.2	4.76	0.8	4.4	Φ40.1 ~ Φ45.0
QPMG150512-DP	●	●	15.2	5.2	1.2	5.5	Φ45.1 ~ Φ51.0

GA4230—Universal Grade

GS4130—Suitable for titanium alloys and heat resistant alloys, and unstable conditions

● Stock ○ Order

Drill Body Parts

Insert Type	Screw		Wrench		N · m Torque
	Type	Ordering Code	Type	Ordering Code	
QPMG040204	SI60M020050-02704	PSI60M020050-02704K	TT06P	PTT06PK	0.6
QPMG050204	SI60M022055-03107	PSI60M022055-03107K	TT07P	PTT07PK	0.8
QPMG060204	SI60M022055-03107	PSI60M022055-03107K	TT07P	PTT07PK	0.8
QPMG07T306	SI60M025070-03509	PSI60M025070-03509K	TT08P	PTT08PK	0.8
QPMG09T308	SI60M030080-04210	PSI60M030080-04210K	TT09P	PTT09PK	1.2
QPMG110408	SI60M040100-05510	PSI60M040100-05510K	TT15P	PTT15PK	2.0
QPMG130408	SI60M022055-03107	PSI60M022055-03107K	TT15P	PTT15PK	2.0
QPMG150512	SI60M050110-07212	PSI60M050110-07212K	TT20P	PTT20PK	2.5

SPMG

General Drill Insert

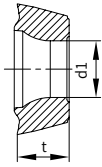
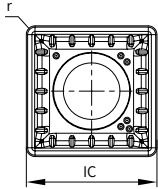

Type	Grade		Dimension				Dia. of Drill
	GA4230	GS4130	IC	t	r	d1	
SPMG050204-DM	●	●	5	2.38	0.4	2.2	Φ13.0 ~ Φ15.0
SPMG060204-DM	●	●	6	2.38	0.4	2.6	Φ15.5 ~ Φ21.5
SPMG07T308-DM	●	●	7.94	3.97	0.8	2.8	Φ22.0 ~ Φ27.5
SPMG090408-DM	●	●	9.8	4.3	0.8	4.23	Φ28.0 ~ Φ33.0
SPMG110408-DM	●	●	11.5	4.76	0.8	4.4	Φ33.0 ~ Φ41.0
SPMG140512-DM	●	●	14.3	5.2	1.2	5.75	Φ42.0 ~ Φ50.0

GA4230— Universal Grade

GS4130—Suitable for titanium alloys and heat resistant alloys, and unstable conditions

● Stock ○ Order

WCMT

General Drill Insert

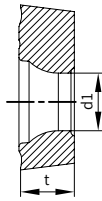
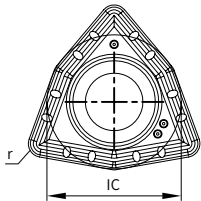

Type	Grade	Dimension				Dia. of Drill	Stock
		IC	t	r	d1		
WCMT030208-DU	GA4230	5.56	2.38	0.8	2.8	Φ15.0 ~ Φ20.5	●
WCMT040208-DU	GA4230	6.35	2.38	0.8	2.9	Φ21.0 ~ Φ24.5	●
WCMT050308-DU	GA4230	7.94	3.18	0.8	3.4	Φ25.0 ~ Φ30.0	●
WCMT06T308-DU	GA4230	9.52	3.97	0.8	3.8	Φ30.5 ~ Φ39.5	●
WCMT080412-DU	GA4230	12.7	4.76	1.2	4.4	Φ40.0 ~ Φ60.0	●

● Stock ○ Order

Recommended Cutting Data

Indexable Drill

	Workpiece Materials	Material Hardness (HB)	Vc Recommended Cutting Speed (m/min)	Feed (mm/rev)*Refer to Diameter Range *			
				Ø14.0 – 22.5	Ø23.0 – 27.0	Ø27.5 – 33.0	Ø33.5 – 51.0
P	Low Carbon Steel	80 – 170	(240) 160 – 300	0.04-0.06	0.04-0.06	0.04-0.08	0.04-0.08
	High Carbon Steel	170 – 250	(180) 140 – 220	0.04-0.10	0.04-0.12	0.06-0.16	0.08-0.18
	Low Alloy Steel	140 – 260	(180) 160 – 250	0.04-0.10	0.06-0.12	0.08-0.16	0.08-0.18
	High Alloy Steel	180 – 300	(160) 140 – 200	0.04-0.10	0.06-0.12	0.08-0.16	0.08-0.18
	Cast Steel	180 – 300	(160) 140 – 200	0.05-0.08	0.06-0.12	0.08-0.14	0.08-0.16
M	(Fer/Mar) Stainless Steel	150 – 270	(140) 120 – 200	0.04-0.10	0.06-0.12	0.06-0.14	0.06-0.16
	Austenitic	150 – 270	(140) 110 – 200	0.04-0.10	0.06-0.12	0.06-0.14	0.06-0.16
K	Forged Cast Iron	150 – 230	(160) 120 – 220	0.04-0.10	0.06-0.14	0.06-0.16	0.08-0.20
	Gray Cast Iron	150 – 230	(180) 140 – 230	0.04-0.10	0.06-0.14	0.06-0.16	0.08-0.20
	Nodular Cast Iron	160 – 260	(160) 130 – 210	0.04-0.12	0.06-0.16	0.08-0.18	0.08-0.20
S	(Ni+/Fe+/Co+)HRSA	130 – 400	(50) 30-80	0.04-0.06	0.04-0.08	0.04-0.10	0.06-0.12
	(Ti+)HRSA	130 – 400	(50) 30-70	0.04-0.08	0.04-0.10	0.06-0.12	0.08-0.11
H	Hardened Steel	400 –	(45) 30-60	0.04-0.08	0.04-0.10	0.06-0.12	0.08-0.14

ES Eccentric Sleeve

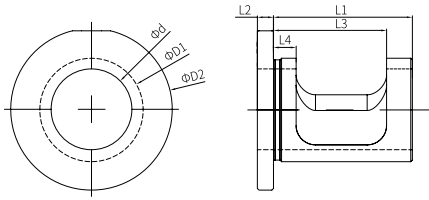

Type	Dimension							Adjustment Range
	ϕd	$\phi D1$	$\phi D2$	L1	L2	L3	L4	
ES2025A	20	25	40	45	5	36	3.0	-0.2 - +0.4
ES2532A	25	32	50	48	5	38	2.5	-0.2 - +0.4
ES3240A	32	40	60	55	5	43	2.5	-0.2 - +0.4
ES4050A	40	50	70	65	5	49	3.0	-0.2 - +0.4

Instructions for ES Eccentric Sleeve

减小0.2mm位置

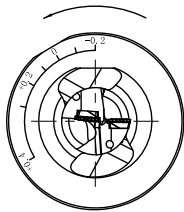

0点位置

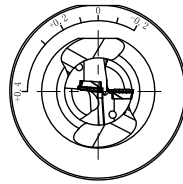

增大0.4mm位置

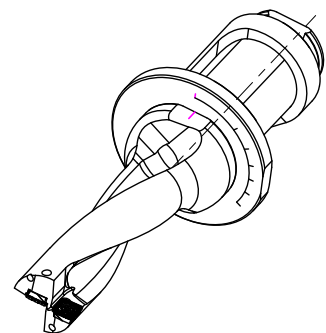
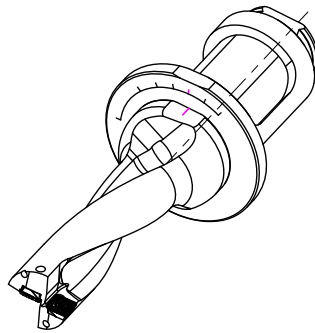
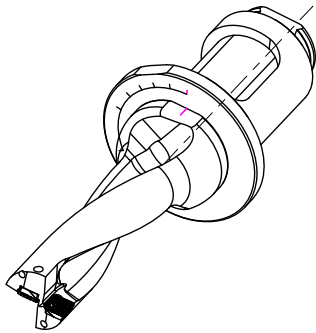
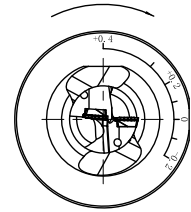

C

Indexable Boring Tools

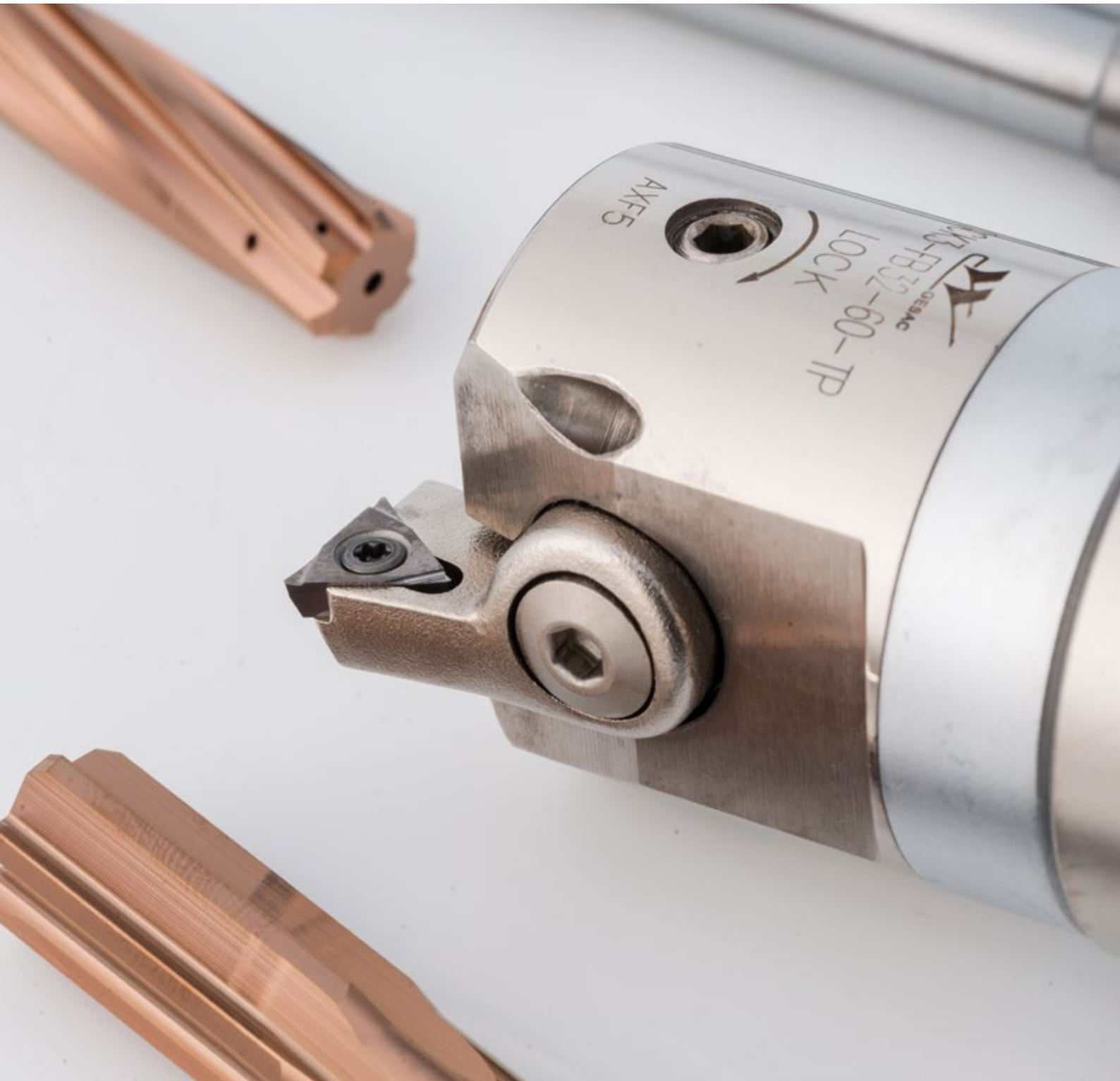

Modular Boring System



RB

Rough Boring Body

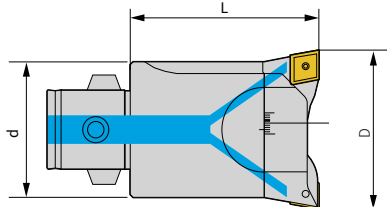

Ordering code	d	L	Screw A	Screw B	Wrench	Weight	Stock
RB19	11	21.5	PSCAM040160D	PSCAM040160D	PTH03LD	0.16	●
RB25	14	40	PSCAM040160D	PSCAM040160D	PTH03LD	0.33	●
RB32	18	52	PSCAM050100D	PSCAM050200D	PTH40LD	0.49	●
RB40	22	48	PSCAM060120D	PSCAM060200D	PTH50LD	0.98	●
RB50	28	62	PSCAM050120D	PSCAM060250D	PTH50LD	1.60	●
RB63	36	60	PSCAM050160D	PSCAM080300D	PTH60LD	1.93	●
RB80	36	60	PSCAM050160D	PSCAM080300D	PTH60LD	0.56	●

● Standard Stock ○ Available Upon Order

DZA/DZB

Rough Boring tool Insert Holder

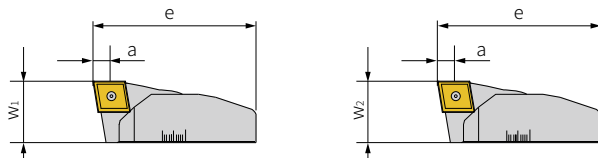

Ordering code		e	W1	W2	a	Boring range	Boring adapter	Insert	Screw	Wrench	Weight	Stock
High flute insert holder A	Low flute insert holder B											
DZA2026	DZB2026	17.0	13.2	13.0	0.5-2	20-26	RB19	CCMT0602	PSI55M060025-35010D	PTT08PD	0.01	●
DZA2533	DZB2533	20.9	13.2	13.0	0.5-2	25-33	RB19	CCMT0602	PSI55M060025-35010D	PTT08PD	0.01	●
DZA2936	DZB2936	25	11.7	11.5	0.5-2	29-36	RB25	CCMT0602	PSI55M060025-35010D	PTT08PD	0.17	●
DZA3542	DZB3542	30	11.7	11.5	0.5-2	35-42	RB25	CCMT0602	PSI55M060025-35010D	PTT08PD	0.19	●
DZA3645	DZB3645	32	11.7	11.5	0.5-2	36-45	RB32	CCMT0602	PSI55M060025-35010D	PTT08PD	0.37	●
DZA4453	DZB4453	38	11.7	11.5	0.5-2	44-53	RB32	CCMT0602	PSI55M060025-35010D	PTT08PD	0.37	●
DZA4556	DZB4556	40	15.6	15.4	0.5-3	45-56	RB40	CCMT09T3	PSI60M100040-57010D	PTT15PD	0.56	●
DZA5566	DZB5566	40.5	15.6	15.4	0.5-3	55-66	RB40	CCMT09T3	PSI60M100040-57010D	PTT15PD	0.58	●
DZA5674	DZB5674	49	17.6	17.4	0.5-3	56-74	RB50	CCMT09T3	PSI60M100040-57010D	PTT15PD	1.10	●
DZA7492	DZB7492	62	17.6	17.4	0.5-3	74-92	RB50	CCMT09T3	PSI60M100040-57010D	PTT15PD	1.14	●
DZA7090	DZB7090	60	22.6	22.4	0.5-4	70-90	RB63	CCMT1204	PSI45M110050-70010D	PTT20PD	1.78	●
DZA90110	DZB90110	78	22.6	22.4	0.5-4	90-110	RB63	CCMT1204	PSI45M110050-70010D	PTT20PD	1.90	●
DZA90130	DZB90130	82	22.6	22.4	0.5-4	90-130	RB80	CCMT1204	PSI45M110050-70010D	PTT20PD	2.30	●
DZA130170	DZB130170	99.5	22.6	22.4	0.5-4	130-170	RB80	CCMT1204	PSI45M110050-70010D	PTT20PD	2.44	●

● Standard Stock ○ Available Upon Order

DZA/DZB

Rough and Back Boring tool Insert Holder

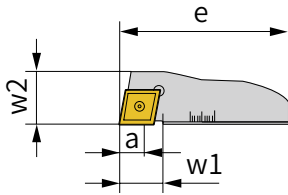

Back boring tool insert holder C	e	w1	w2	Boring range	Adapter size	Insert	Screw	Wrench	Weight	Clamp	Stock
DZCF2936	25	4	11	29-36	RB25	CCMT0602	PSI55M060025-35010D	PTT08PD	0.01	YB25	●
DZCF3542	30	7	11	35-42	RB25	CCMT0602	PSI55M060025-35010D	PTT08PD	0.02	YB25	●
DZCF3645	32	5	11	36-45	RB32	CCMT0602	PSI55M060025-35010D	PTT08PD	0.02	YB32	●
DZCF4453	38	9	11	44-53	RB32	CCMT0602	PSI55M060025-35010D	PTT08PD	0.02	YB32	●
DZCF4556	40	5	15	45-56	RB40	CCMT09T3	PSI60M100040-57010D	PTT15PD	0.04	YB40	●
DZCF5566	40.5	12	15	55-66	RB40	CCMT09T3	PSI60M100040-57010D	PTT15PD	0.05	YB40	●
DZCF5674	49	11	17	56-74	RB50	CCMT09T3	PSI60M100040-57010D	PTT15PD	0.07	YB50	●
DZCF7492	62	17	17	74-92	RB50	CCMT09T3	PSI60M100040-57010D	PTT15PD	0.09	YB50	●
DZCF7090	60	12	21	70-90	RB63	CCMT1204	PSI45M110050-70010D	PTT20PD	0.13	YB63	●
DZCF90110	78	22	21	90-110	RB63	CCMT1204	PSI45M110050-70010D	PTT20PD	0.18	YB63	●
DZCF90130	82	24	21.5	90-130	RB80	CCMT1204	PSI45M110050-70010D	PTT20PD	0.18	YB80	●
DZCF130170	102.5	24	21.5	130-170	RB80	CCMT1204	PSI45M110050-70010D	PTT20PD	0.28	YB80	●

● Standard Stock ○ Available Upon Order

RB

Rough Boring Tool

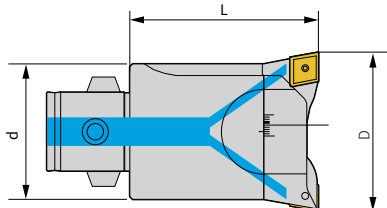

Ordering code	d	L	Boring range	Adapter size	Insert holder	Weight	Stock
GCK1-RB19-M	19	32.5	20-26	GCK1	DZA2026 DZB2026	0.09	●
GCK1-RB19-L	19	32.5	25-31	GCK1	DZA2533 DZB2533	0.1	●
GCK2-RB25-M	25	50	29-36	GCK2	DZA2936 DZB2936	0.17	●
GCK2-RB25-L	25	50	35-42	GCK2	DZA3542 DZB3542	0.19	●
GCK3-RB32-M	32	65	36-45	GCK3	DZA3645 DZB3645	0.37	●
GCK3-RB32-L	32	65	44-53	GCK3	DZA4453 DZB4453	0.37	●
GCK4-RB40-M	40	63	45-56	GCK4	DZA4556 DZB4556	0.56	●
GCK4-RB40-L	40	63	55-66	GCK4	DZA5566 DZB5566	0.58	●
GCK5-RB50-M	50	80	56-74	GCK5	DZA5674 DZB5674	1.10	●
GCK5-RB50-L	50	80	74-92	GCK5	DZA7492 DZB7492	1.14	●
GCK6-RB63-M	64	82	70-90	GCK6	DZA7090 DZB7090	1.78	●
GCK6-RB63-L	64	82	90-110	GCK6	DZA90110 DZB90110	1.90	●
GCK6-RB80-M	80	82	90-130	GCK6	DZA90130 DZB90130	2.30	●
GCK6-RB80-L	80	82	130-170	GCK6	DZA130170 DZB130170	2.44	●

Remarks: Quotation with the insert holder

● Standard Stock ○ Available Upon Order

RB

Rough Back-boring Tool

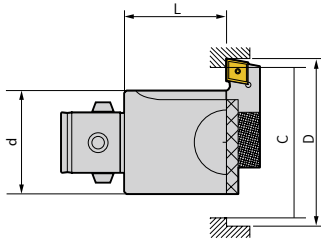

Ordering code	D1	L	Back boring range	Adapter size	Insert holder	Weight	Clamp	Stock
GCK2-RB25-MF	25	50	29-36	GCK2	DZCF2936	0.17	YB25	●
GCK2-RB25-LF	25	50	35-42	GCK2	DZCF3542	0.19	YB25	●
GCK3-RB32-MF	32	63	36-45	GCK3	DZCF3645	0.37	YB32	●
GCK3-RB32-LF	32	63	44-53	GCK3	DZCF4453	0.37	YB32	●
GCK4-RB40-MF	40	63	45-56	GCK4	DZCF4556	0.56	YB40	●
GCK4-RB40-LF	40	63	55-66	GCK4	DZCF5566	0.58	YB40	●
GCK5-RB50-MF	50	80	56-74	GCK5	DZCF5674	1.10	YB50	●
GCK5-RB50-LF	50	80	74-92	GCK5	DZCF7492	1.14	YB50	●
GCK6-RB63-MF	64	80	70-90	GCK6	DZCF7090	1.78	YB63	●
GCK6-RB63-LF	64	80	90-110	GCK6	DZCF90110	1.90	YB63	●
GCK6-RB80-MF	80	80	90-130	GCK6	DZCF90130	2.30	YB80	●
GCK6-RB80-LF	80	80	130-170	GCK6	DZCF130170	2.44	YB80	●

Remarks: Quotation with the insert holder

● Standard Stock ○ Available Upon Order

LRB

Large Diameter Rough Boring Tool

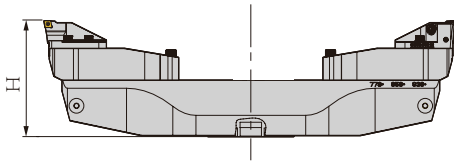

Ordering code	H	Boring range	Adapter size	Insert holder	Insert	Weight	Stock
GCA-LRB148-200	102	148-200	GCA	DPZRBCC12 DPZRBBCN16	CC**1204\CN**1606	3.86	●
GCA-LRB198-250	102	198-250	GCA		CC**1204\CN**1606	4.39	●
GCA-LRB248-300	102	248-300	GCA		CC**1204\CN**1606	4.87	●
GCB-LRB298-380	114	298-380	GCB		CC**1204\CN**1606	8.97	●
GCB-LRB378-460	119	378-460	GCB		CC**1204\CN**1606	10.73	○
GCB-LRB458-540	124	458-540	GCB		CC**1204\CN**1606	12.66	○
GCB-LRB538-780	198	538-780	GCB		CC**1204\CN**1606	25.11	○
GCB-LRB778-1020	218	778-1020	GCB		CC**1204\CN**1606	36.30	○
GCB-LRB1018-1260	218	1018-1260	GCB		CC**1204\CN**1606	43.73	○

Remarks: Quotation with the spare parts

● Standard Stock ○ Available Upon Order

Ordering code	H	Parts	Adapter size	Insert holder
DPZRBCC12	CCMT120408	PSI45M110050-70010D	PTT20PD PTH30LD/ PTH40LD	0.25
DPZRBBCN16	CNMG1606	STMC1604 STML0828 STMX0822 STMY0823		0.3

FB

Finishing Boring Tool

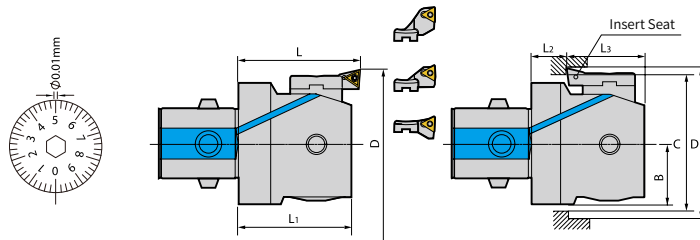

Ordering code	Insert holder	Boring		range D	Back Boring			range D	Insert	Screw	Wrench	Weight	Stock						
		L1	L		B	L2	L3												
GCK1-FB20-36	DPZFB1-A			20-26				-	TPGT080202	PSI65M050020-27010D	PTT06PD	0.06	●						
	DPZFB1-B	29.5	32.5	25-31	10	10.5	19	-				0.06	●						
	DPZFB1-C			30-36				30-36				0.06	●						
GCK2-FB25-47	DPZFB2-A			25-33				-				TCMT110204 (Standard) TPGH110304 (Optional)	PSI55M070030-40010D (Standard) PSI55M060025-35010D (Optional)	PTT08PD	0.12	●			
	DPZFB2-B	32.5	35.5	32-40	12.5	11.5	21	36-40							0.12	●			
	DPZFB2-C			39-47				39-47							0.12	●			
GCK3-FB32-60	DPZFB3-A			32-42				-							TCMT110204 (Standard) TPGH110304 (Optional)	PSI55M070030-40010D (Standard) PSI55M060025-35010D (Optional)	PTT08PD	0.20	●
	DPZFB3-B	35	40	41-51	16	10	25	46-51										0.20	●
	DPZFB3-C			50-60				50-60										0.20	●
GCK4-FB41-74	DPZFB4-A			41-54				-	TCMT110204 (Standard) TPGH110304 (Optional)	PSI55M070030-40010D (Standard) PSI55M060025-35010D (Optional)	PTT08PD							0.39	●
	DPZFB4-B	43	47	50-63	20	14	29	53-63										0.39	●
	DPZFB4-C			61-74				61-74										0.39	●
GCK5-FB53-95	DPZFB5-A			53-70				62-70				TCMT110204 (Standard) TPGH110304 (Optional)	PSI55M070030-40010D (Standard) PSI55M060025-35010D (Optional)	PTT08PD				0.80	●
	DPZFB5-B	53	57	65-82	25.5	19	34	65-82										0.80	●
	DPZFB5-C			78-95				78-95										0.80	●
GCK6-FB68-150	DPZFB6-A			68-100				80-100							TCMT110204 (Standard) TPGH110304 (Optional)	PSI55M070030-40010D (Standard) PSI55M060025-35010D (Optional)	PTT08PD	1.75	●
	DPZFB6-B	67.2	71	94-126	32.5	22	45.2	94-126										1.75	●
	DPZFB6-C			118-150				118-150										1.75	●
GCK7-FB100-203	DPZFB6-A			110-153				112-153	TCMT110204 (Standard) TPGH110304 (Optional)	PSI55M070030-40010D (Standard) PSI55M060025-35010D (Optional)	PTT08PD							2.47	●
	DPZFB6-B	67.2	71	126-179	45.5	22	45.2	126-179										2.47	●
	DPZFB6-C			150-203				150-203										2.47	●

1. Quotation with 1 PC insert holder DPZFBX-A, while DPZFBX-B and DPZFBX-C shall be ordered separately
 2. Back boring need to meet the condition as follow
 $C > B + D / 2$
 C: Minimum through-hole diameter B: Boring cutter radius D: Back boring machining
 Spindle reverses rolling when reverse boring.

● Standard Stock ○ Available Upon Order

DPZFB

Insert Seat



Ordering code		Figure	Insert	Boring head	Stock	
DPZFB	1-A		TPGH080202	GCK1-FB20-36	●	
	1-B				●	
	1-C				●	
	2-A			●		
	2-B			●		
	2-C			●		
	3-A			●		
	3-B			●		
	3-C			●		
	4-A-TP/TC			TCMT110204 (Standard) TPGH110304 (Optional)	GCK4-FB41-74	●
	4-B-TP/TC					●
	4-C-TP/TC				●	
	5-A-TP/TC		GCK5-FB53-95		●	
	5-B-TP/TC				●	
	5-C-TP/TC		●			
	6-A-TP/TC		GCK6-FB68-150 GCK7-FB100-203	●		
	6-B-TP/TC			●		
	6-C-TP/TC			●		

Remarks:

- 1.Quotation with 1 PC insert holder DPZFBX-1,while DPZFBX-2 and DPZFBX-3 shall be ordered separately
- 2.Over DPZFB4 with TCMTT11 and TPEH11 two different types ,it can be selected according to actual working condition

● Standard Stock ○ Available Upon Order

LFB

Large Diameter Finishing Boring Tool

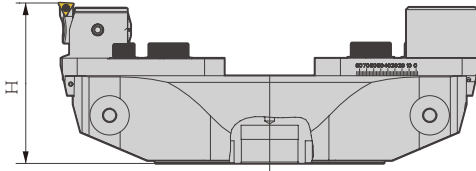

Ordering code	H	Boring range	Adapter size	Back Boringrange	Back boring depth	Weight	Stock
GCA-LFB148-215	109	148-215	GCA	38-105	30	3.18	●
GCA-LFB198-265	109	198-265	GCA	88-155	30	3.71	●
GCA-LFB248-315	109	248-315	GCA	148-205	30	4.19	●
GCB-LFB298-395	113	298-395	GCB	188-285	25	9.5	○
GCB-LFB378-475	118	378-475	GCB	268-365	25	11.26	○
GCB-LFB458-555	123	458-555	GCB	348-445	25	25.64	○
GCB-LFB538-795	197	538-795	GCB	428-685	25	13.19	○
GCB-LFB778-1035	217	778-1035	GCB	668-925	25	36.83	○
GCB-LFB1018-1275	217	1018-1275	GCB	908-1165	25	44.26	○

Remarks: Quotation with the spare parts

● Standard Stock ○ Available Upon Order

Insert Seat	Insert	Screw	Wrench	Weight
DPZFB5-B-TC	TCMT110204	PSI55M070030-40010D	Q08B	0.04
DPZFB5-B-TP	TPGH110304	PSI55M060025-35010D		0.04

SFB

Micro-boring Tool

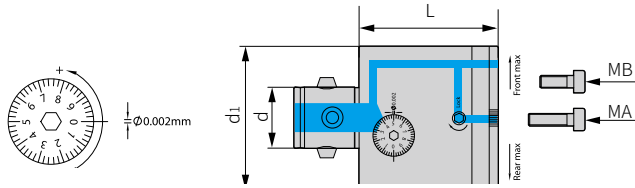

Type	d1	L	Boring range	Adapter size	Insert holder	Weight	Stock
GCK2-SFB25-M	25	50	29-38	GCK2	DPZ2938	0.15	○
GCK3-SFB32-M	32	63	36-52	GCK3	DPZ3652	0.33	○
GCK4-SFB40-M	40	63	48-68	GCK4	DPZ4868	0.53	○
GCK5-SFB50-BM	50	80	57-80	GCK5	DPZ5780	1.02	○
GCK6-SFB63-BMA	64	8	70-110	GCK6	DPZ70110	1.70	○
GCK6-SFB80-BMB	80	100	110-150	GCK6	DPZ110150	3.50	○

Remarks: Quotation with SFB series insert holder

● Standard Stock ○ Available Upon Order

SFB

Boring Tool Insert Holder

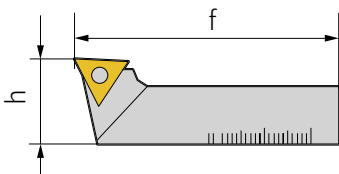

Ordering code	h	f	Boring range	Adapter size	Insert holder	Screw	Wrench	Weight	Stock	
DPZ	2938	11	27	29-38	GCK2-SFB25	TPGH0902..L	PSI55M060025-35010D	PTT08PD	0.01	○
	3652	13	35	36-52	GCK3-SFB32	TPGH0902..L	PSI55M060025-35010D	PTT08PD	0.02	○
	4868	13	43	48-68	GCK4-SFB40	TPGH0902..L	PSI55M060025-35010D	PTT08PD	0.03	○
	5780	20	54	57-80	GCK5-SFB50	TPGH1103..L	PSI55M070030-40010D	PTT08PD	0.09	○
	70110	20	66	70-110	GCK6-SFB63	TPGH1103..L	PSI55M070030-40010D	PTT08PD	0.14	○
	110150	20	106	110-150	GCK6-SFB80	TPGH1103..L	PSI55M070030-40010D	PTT08PD	0.25	○

● Standard Stock ○ Available Upon Order

SFB

Micaro -boring Bar

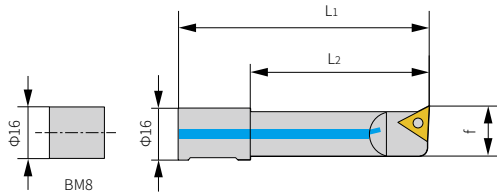

Ordering code	L1	L2	Boring range	Adapter size	Insert holder	Screw	Wrench	Weight	Stock
DG1606-21	65	21	6-9	GCK5-SFB50 GCK6-SFB63 GCK6-SFB80	WBG0201..L	PSI55M040020-27010D	PTT06PD	0.04	○
DG1608-28	63	28	8-11		TBGT0601..L	PSI55M040020-27010D	PTT06PD	0.04	○
DG1610-35	63	35	10-13		TBGT0601..L	PSI55M040020-27010D	PTT06PD	0.05	○
DG1612-42	73	42	12-15		TPEH0902..L	PSI55M060025-35010D	PTT08PD	0.06	○
DG1614-50	78.5	50	14-17		TPEH0902..L	PSI55M060025-35010D	PTT08PD	0.08	○
DG1616-60	88	60	16-20		TPEH0902..L	PSI55M060025-35010D	PTT08PD	0.11	○
DG1620-65	92	65	20-24		TPEH1103..L	PSI55M070030-40010D	PTT08PD	0.06	○
DG1624-68	95	68	24-28		TPEH1103..L	PSI55M070030-40010D	PTT08PD	0.20	○

● Standard Stock ○ Available Upon Order

GBJ16

Micro-boring Head

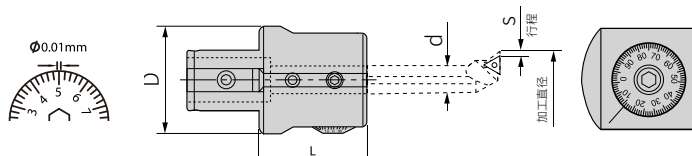

Ordering code	D	d	L	Dial distance	Micro precision	Adapter size	Boring Range	Screw	Screw	Wrench	Weight	Stock
GBJ16	63	16	50	0.01	5	GCK6	8-50	PSTCM0100110D	PSTCM0100070D	PTH50PK	1.14	●

Remarks:Quotation without holder ,recommend to change the holder to BT40/BT50 GCK6-55

● Standard Stock ○ Available Upon Order

GBJ16

Micro-boring Bar

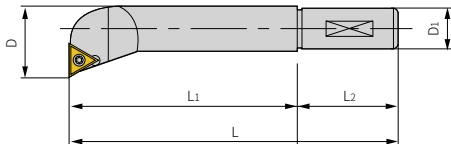

Ordering code	D	D1	L1	L2	L	Insert	Boring Range	Screw	Wrench	Weight	Stock
1606-24	6	16	24	34	66	TBGT0601..L	6-8	PSI55M040020-27010D	PTT06PD	0.06	●
1608-32	8	16	32	32	64	TBGT0601..L	8-11	PSI55M040020-27010D	PTT06PD	0.07	●
1610-40	10	16	40	32	72	TBGT0601..L	10-13	PSI55M040020-27010D	PTT06PD	0.07	●
1612-53	12	16	53	32	85	TPGH0902..L	12-17	PSI55M060025-35010D	PTT08PD	0.09	●
GBJ 1616-68	16	16	68	32	100	TPGH0902..L	16-21	PSI55M060025-35010D	PTT08PD	0.13	●
1620-83	20	16	83	32	115	TPGH0902..L	20-26	PSI55M070030-40010D	PTT08PD	0.20	●
1625-90	25	16	90	32	122	TPGH1102..L	25-32	PSI55M070030-40010D	PTT08PD	0.25	●
1630-90	30	16	90	32	122	TPGH1102..L	30-42	PSI55M070030-40010D	PTT08PD	0.25	●
1640-90	40	16	90	32	122	TPGH1102..L	40-50	PSI55M070030-40010D	PTT08PD	0.26	●

● Standard Stock ○ Available Upon Order

GBJ16

Micro-boring Tool Kit



Ordering code	Range	Adapter	Weight	Stock
BT40-GBJ16-8PCS	8-50	BT40-GCK6-55	3.68	●
BT50-GBJ16-8PCS	8-50	BT50-GCK6-85	6.74	●

● Standard Stock ○ Available Upon Order

GBH2084

Micro-boring head

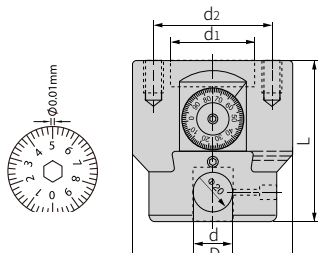

Ordering code	D	d	d1	d2	L	Micro distance	Boring Range	Dial precision	Adaptsize	Weight	Stock
GBH2084	84	20	35	60	80	28	8-280	0.01	GBH-A.B	2.74	○
						Adjusting screw	Wrench	Locking screw	Wrench		
						PSTCM080160D	PTH40PK	PSTCM0120140D	PTH60PK		

Remarks:Quotation with holder ,please confirm the type of the machine spindle interface with our staff.

GBH2084

Micro-boring bar

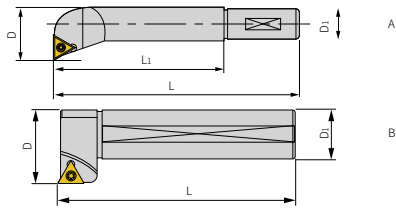

Ordering code	D	D1	L1	L	Figure	Insert	Range	Screw	Wrench	Weight	Stock
2008-32	8	20	32	74	A	TBGT0601L	8-11	PSI55M040020-27010D	PTT06PD	0.09	●
2010-40	10	20	40	75	A	TBGT0601L	10-13	PSI55M040020-27010D	PTT06PD	0.10	●
2012-53	12	20	53	88	A	TPGH0902L	12-17	PSI55M060025-35010D	PTT08PD	0.12	●
2016-68	16	20	68	103	A	TPEH0902L	16-21	PSI55M060025-35010D	PTT08PD	0.16	●
2020-83	20	20	83	115	A	TPEH1103L	20-26	PSI55M070030-40010D	PTT08PD	0.22	●
2025-96	25	20	96	131	A	TPEH1103L	25-135	PSI55M070030-40010D	PTT08PD	0.35	●
2030-115	30	20	115	159	A	TPGH1103L	30-140	PSI55M070030-40010D	PTT08PD	0.52	●
20120-97	30	20	-	97	B	TPGH1103L	120-280	PSI55M070030-40010D	PTT08PD	0.25	●

GBH

● Standard Stock ○ Available Upon Order

GBH2084

Micro-boring Tool Kit



Ordering code	Range	Adapter	Weight	Stock
BT40-GBH2084-8PCS	8-280	BT40- GBH-A50	6.44	●
BT50-GBH2084-8PCS	8-280	BT50- GBH-A50	8.89	●

● Standard Stock ○ Available Upon Order

BT-GCK

Boring Adapter

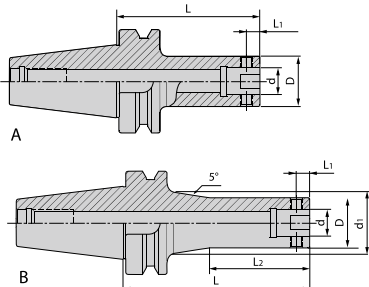

Ordering code	Diagram	D	d1	d	L1	L2	L	Screw	Wrench	Weight	Stock
GCK1-70	A	19	-	11	5.05	-	70	PSTCM050050D	PTH25LD	1.03	●
GCK1-100L	B	19	20.7	11	5.05	60	100	PSTCM050050D	PTH25LD	1.10	●
GCK1-130L	B	19	25.5	11	5.05	60	130	PSTCM050050D	PTH25LD	1.18	●
GCK2-75	A	24	-	14	6.62	-	75	PSTCM050060D	PTH25LD	1.10	●
GCK2-100	A	24	-	14	6.62	-	100	PSTCM050060D	PTH25LD	1.18	●
GCK2-130L	B	24	28.3	14	6.62	75	130	PSTCM050060D	PTH25LD	1.33	●
GCK2-160L	B	24	33.6	14	6.62	75	160	PSTCM050060D	PTH25LD	1.49	●
GCK3-80	A	31	-	18	8	-	80	PSTCM060090D	PTH30LD	1.22	●
GCK3-100	A	31	-	18	8	-	100	PSTCM060090D	PTH30LD	1.32	●
GCK3-135L	B	31	34.5	18	8	75	135	PSTCM060090D	PTH30LD	1.54	●
GCK3-165L	B	31	39.7	18	8	85	165	PSTCM060090D	PTH30LD	1.76	●
GCK4-70	A	39	-	22	10	-	70	PSTCM080120D	PTH40LD	1.21	●
GCK4-100	A	39	-	22	10	-	100	PSTCM080120D	PTH40LD	1.46	●
GCK4-150L	B	39	43.4	22	10	85	150	PSTCM080120D	PTH40LD	1.90	●
GCK4-170L	B	39	46.9	22	10	95	170	PSTCM080120D	PTH40LD	2.16	●
GCK5-60	A	50	-	28	13	-	60	PSTCM100160D	PTH50LD	1.22	●
GCK5-80	A	50	-	28	13	-	80	PSTCM100160D	PTH50LD	1.52	●
GCK5-100	A	50	-	28	13	-	100	PSTCM080120D	PTH50LD	1.80	●
GCK5-150	A	50	-	28	13	-	150	PSTCM100160D	PTH50LD	2.52	●
GCK5-180	A	50	-	28	13	-	180	PSTCM100160D	PTH50LD	2.90	●
GCK6-55	A	64	-	36	16	-	55	PSTCM120200D	PTH60LD	1.22	●
GCK6-100	A	64	-	36	16	-	100	PSTCM120200D	PTH60LD	2.29	●
GCK6-150	A	64	-	36	16	-	150	PSTCM120200D	PTH60LD	3.50	●
GCK6-180	A	64	-	36	16	-	180	PSTCM120200D	PTH60LD	4.22	●
GCK1-80	A	19	-	11	5.05	-	80	PSTCM050050D	PTH25LD	3.20	●
GCK1-115L	B	19	20.7	11	5.05	50	115	PSTCM050050D	PTH25LD	3.73	●
GCK1-145L	B	19	26	11	5.05	60	145	PSTCM050050D	PTH25LD	4.20	●
GCK2-105	A	24	-	14	6.62	-	105	PSTCM050060D	PTH25LD	3.78	●
GCK2-135L	B	24	26.6	14	6.62	65	135	PSTCM050060D	PTH25LD	3.89	●
GCK2-165L	B	24	31.9	14	6.62	75	165	PSTCM050060D	PTH25LD	4.08	●
GCK3-110	A	31	-	18	8	-	110	PSTCM060090D	PTH30LD	3.95	●

● Standard Stock ○ Available Upon Order

BT-GCK

Boring Adapter

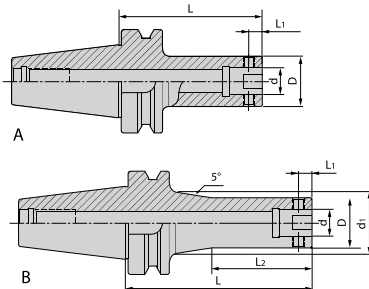

Ordering code	Diagram	D	d1	d	L1	L2	L	Screw	Wrench	Weight	Stock
GCK3-140L	B	31	32.7	18	8	75	140	PSTCM060090D	PTH30LD	4.09	●
GCK3-170L	B	31	38	18	8	85	170	PSTCM060090D	PTH30LD	4.31	●
GCK4-100	A	39	-	22	10	-	100	PSTCM060090D	PTH30LD	3.98	●
GCK4-160L	B	39	42.5	22	10	85	160	PSTCM080120D	PTH40LD	4.50	●
GCK4-205L	B	39	50	22	10	95	205	PSTCM080120D	PTH40LD	5.13	●
GCK5-90	A	50	-	28	13	-	90	PSTCM080120D	PTH40LD	4.30	●
GCK5-165	A	50	-	28	13	-	165	PSTCM100160D	PTH50LD	5.20	●
GCK5-210L	B	50	57.8	28	13	120	210	PSTCM100160D	PTH50LD	5.92	●
GCK5-270L	B	50	68.4	28	13	120	270	PSTCM100160D	PTH50LD	7.23	●
GCK6-85	A	64	-	36	16	-	85	PSTCM100160D	PTH50LD	4.28	●
BT50 GCK6-155	A	64	-	36	16	-	155	PSTCM120200D	PTH60LD	5.97	●
GCK6-215	A	64	-	36	16	-	215	PSTCM120200D	PTH60LD	7.43	●
GCK6-250	A	64	-	36	16	-	250	PSTCM120200D	PTH60LD	8.27	●
GCK6-300L	B	64	80.5	36	16	160	300	PSTCM120200D	PTH60LD	10.21	●
GCK6-350L	B	64	90	36	16	160	350	PSTCM120200D	PTH60LD	12.90	●
GCK7-85	A	90	-	46	19.15	-	85	PSTCM120200D	PTH100LD	4.96	●
GCK7-150	A	90	-	46	19.15	-	-	PSTCM200290D	PTH100LD	6.52	●
GCK7-210	A	90	-	46	19.15	-	-	PSTCM200290D	PTH100LD	8.55	●
GCK7-250	A	90	-	46	19.15	-	-	PSTCM200290D	PTH100LD	10.35	●
GCK7-300	A	90	-	46	19.15	-	-	PSTCM200290D	PTH100LD	12.55	●
GCK7-350	A	90	-	46	19.15	-	-	PSTCM200290D	PTH100LD	13.25	●

● Standard Stock ○ Available Upon Order

GC

Large Diameter Boring Adaptor

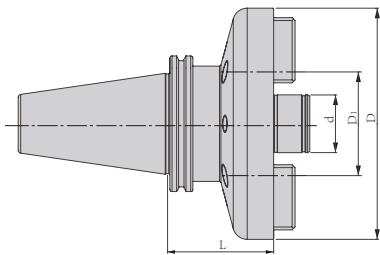

Ordering code	D	d	L	D1	Weight	Stock
BT50-GCA-55	100	40	55	66.7	4.28	●
BT50-GCA-150	100	40	150	66.7	8.63	●
BT50-GCA-200	100	40	200	66.7	10.92	●
BT50-GCA-250	100	40	250	66.7	13.21	●
BT50-GCA-300	100	40	300	66.7	15.5	○
BT50-GCB-85	160	40	85	101.6	8.9	○
BT50-GCB-150	160	40	150	101.6	11.6	○
BT50-GCB-200	160	40	200	101.6	13.69	○
BT50-GCB-250	160	40	250	101.6	15.77	○
BT50-GCB-300	160	40	300	101.6	17.85	○

● Standard Stock ○ Available Upon Order

GSD

Alloy Anti-vibration tool Holder

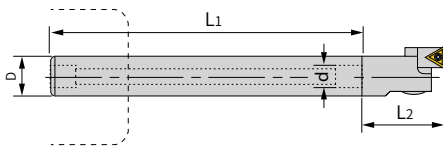

Ordering code	D	d	L1	L2	Adapter	Range	Weight	Stock
C19-GCK1-150	19	11	150	32.5			0.5	○
C19-GCK1-200	19	11	200	32.5	GCK1-FB20-36	20-36	0.7	○
C19-GCK1-250	19	11	250	32.5			0.9	○
C24-GCK2-200	24	14	200	35.5			1.0	○
GSD C24-GCK2-250	24	14	250	35.5	GCK2-FB25-47	25-47	1.2	○
C24-GCK2-300	24	14	300	35.5			1.5	○
C31-GCK3-250	31	18	250	40			1.8	○
C31-GCK3-300	31	18	300	40	GCK3-FB32-60	32-60	2.2	○
C31-GCK3-400	31	18	400	40			3.0	○

● Standard Stock ○ Available Upon Order

GCK

Extension Adaptor

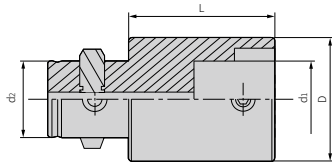

Ordering code	D	d1	d2	L	Screw	Wrench	Weight	Stock	
GCK	1-1-30	19	11	11	30	PSTCM050050D	PTH25LD	0.06	●
	2-2-30	24	14	14	30	PSTCM050060D	PTH25LD	0.09	●
	3-3-30	31	18	18	30	PSTCM060090D	PTH30LD	0.14	●
	4-4-45	39	22	22	45	PSTCM080120D	PTH40LD	0.29	●
	4-4-60	39	22	22	60	PSTCM080120D	PTH40LD	0.47	●
	5-5-60	50	28	28	60	PSTCM100160D	PTH50LD	0.75	●
	5-5-90	50	28	28	90	PSTCM100160D	PTH50LD	1.18	●
	6-6-60	64	36	36	60	PSTCM120200D	PTH60LD	1.46	●
	6-6-100	64	36	36	100	PSTCM120200D	PTH60LD	2.35	●

● Standard Stock ○ Available Upon Order

GCK

Reduction Adaptor

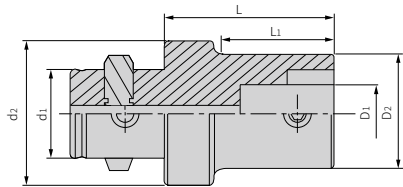

Ordering code	D1	D2	d1	d2	L1	L	Screw	Wrench	Weight	Stock
2-1-36	11	19	14	24	30	36	PSTCM050050D	PTH25LD	0.08	●
3-1-41	11	19	18	31	30	41	PSTCM050050D	PTH30LD	0.12	●
3-2-37	14	24	18	31	25	37	PSTCM050060D	PTH30LD	0.13	●
4-1-58	11	19	22	39	40	58	PSTCM050050D	PTH40LD	0.24	●
4-2-50	14	24	22	39	36	50	PSTCM050060D	PTH40LD	0.22	●
4-3-50	18	31	22	39	37	50	PSTCM060090D	PTH40LD	0.30	●
5-1-60	11	19	28	50	40	60	PSTCM050050D	PTH50LD	0.38	●
5-2-54	14	24	28	50	35	54	PSTCM050060D	PTH50LD	0.38	●
5-2-74	14	24	28	50	55	74	PSTCM050060D	PTH50LD	0.45	●
5-3-47	18	31	28	50	29	47	PSTCM060090D	PTH50LD	0.46	●
5-3-72	18	31	28	50	54	72	PSTCM060090D	PTH50LD	0.54	●
5-4-42	22	39	28	50	25	42	PSTCM080120D	PTH50LD	0.43	●
5-4-67	22	39	28	50	50	67	PSTCM080120D	PTH50LD	0.62	●
6-1-70	11	19	36	64	40	70	PSTCM050050D	PTH60LD	0.90	●
6-2-63	14	24	36	64	45	63	PSTCM050060D	PTH60LD	0.66	●
6-2-93	14	24	36	64	75	93	PSTCM050060D	PTH60LD	0.71	●
6-3-56	18	31	36	64	39	56	PSTCM060090D	PTH60LD	0.70	●
6-3-96	18	31	36	64	79	96	PSTCM060090D	PTH60LD	0.91	●
6-4-51	22	39	36	64	35	51	PSTCM080120D	PTH60LD	0.76	●
6-4-101	22	39	36	64	85	101	PSTCM080120D	PTH60LD	1.19	●
6-5-41	28	50	36	64	25	41	PSTCM100160D	PTH60LD	0.72	●
6-5-91	28	50	36	64	75	91	PSTCM100160D	PTH60LD	1.46	●

GCK

● Standard Stock ○ Available Upon Order

Insert Screw Wrench



Insert	Connector	Screw	Wrench	Stock
TBGT0601...L		PSI55M040020-27010D	PTT06PD	●
TPGT0802...L		PSI55M050020-27010D	PTT08PD	●
TPGH0902...L		PSI55M060025-35010D	PTT08PD	●
TPGH1103...L		PSI55M070030-40010D	PTT08PD	●
TCMT1102		PSI55M060025-35010D	PTT08PD	●
CCMT0602		PSI55M060025-35010D	PTT08PD	●
CCMT09T3		PSI60M100040-57010D	PTT15PD	●
CCMT1204		PSI45M110050-70010D	PTT20PD	●
	GCK1	PSTCM050050D	PTH25LD	○
	GCK2	PSTCM050060D	PTH25LD	○
	GCK3	PSTCM060090D	PTH30LD	○
	GCK4	PSTCM080120D	PTH40LD	○
	GCK5	PSTCM100160D	PTH50LD	○
	GCK6	PSTCM120200D	PTH60LD	○

● Standard Stock ○ Available Upon Order

R733-C

Reamer for Composite Material

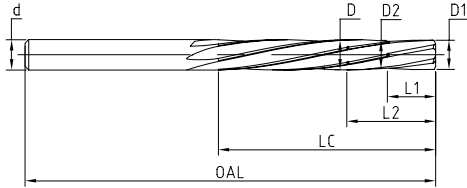

Ordering code	D(mm)	D (in)	D1	L1	D2	L2	Lc	OAL	d	Wire
R733-C-0326	3.26	0.128	3.10	6.5	-	-	35	75	3.26	30#
R733-C-0357	3.57	0.141	3.26	6.5	3.45	13.0	35	75	3.57	28#
R733-C-0400	4.00	0.157	3.45	6.5	3.86	13.0	35	75	4.00	-
R733-C-0417	4.17	0.164	3.86	6.5	4.00	13.0	40	100	4.17	-
R733-C-0450	4.50	0.177	4.17	6.5	4.39	13.0	40	100	4.50	-
R733-C-0485	4.85	0.191	4.50	6.5	4.70	13.0	40	100	4.85	11#
R733-C-0500	5.00	0.197	4.70	6.5	4.85	13.0	40	100	5.00	-
R733-C-0536	5.36	0.211	4.85	6.5	5.20	13.0	40	100	5.36	6#

Unit (mm)

Work Piece							
P			M	N			
1 2 3 4	5	6	1 2 3	1 2	3	4	5
Carbon steel Alloy steel (<35HRC)	Alloy steel Tool steel (35-48HRC)	PH and Ferrite / Martensite steel	Stainless steel	Forged aluminium alloy Cast aluminium alloy (Si ≤ 12%)	Cast aluminium alloy (Si > 12%)	Copper alloy (<200HB)	Composite material
							☉

☉ Most Suitable ○ Suitable

Recommended Cutting Data ※ P128

R733-CM

Reamer for Composite and Metal

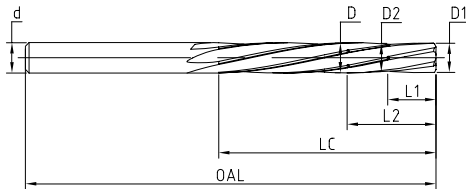

Ordering code	D(mm)	D (in)	D1	L1	D2	L2	Lc	OAL	d	Wire
R733-C-0326	3.26	0.128	3.10	6.5	-	-	35	75	3.26	30#
R733-C-0357	3.57	0.141	3.26	6.5	3.45	13.0	35	75	3.57	28#
R733-C-0400	4.00	0.157	3.45	6.5	3.86	13.0	35	75	4.00	-
R733-C-0417	4.17	0.164	3.86	6.5	4.00	13.0	40	100	4.17	-
R733-C-0450	4.50	0.177	4.17	6.5	4.39	13.0	40	100	4.50	-
R733-C-0485	4.85	0.191	4.50	6.5	4.70	13.0	40	100	4.85	11#
R733-C-0500	5.00	0.197	4.70	6.5	4.85	13.0	40	100	5.00	-
R733-C-0536	5.36	0.211	4.85	6.5	5.20	13.0	40	100	5.36	6#

Unit (mm)

Work Piece							
P			M	N			
1 2 3 4	5	6	1 2 3	1 2	3	4	5
Carbon steel Alloy steel (<35HRC)	Alloy steel Tool steel (35-48HRC)	PH and Ferrite / Martensite steel	Stainless steel	Forged aluminium alloy Cast aluminium alloy (Si≤12%)	Cast aluminium alloy (Si>12%)	Copper alloy (<200HB)	Composite material
							☉

☉ Most Suitable ○ Suitable

Recommended Cutting Data ※ P129

Recommended Cutting Data

Indexable boring system

Work Piece	Dia	Finishing-Boring			Roughing			
		V(m/min)	Feed (mm/rev)	Ap (mm)	V (m/min)	Feed (mm/rev)	Ap (mm)	
P	Carbon steel	25-33	110-140	0.05-0.15	0.05-0.3	100-300	0.15-0.25	2.2
		32-42	115-150	0.05-0.15	0.05-0.3	105-140	0.15-0.3	2.7
		40-55	115-150	0.05-0.15	0.06-0.35	105-150	0.15-0.3	2.7
		52-70	115-150	0.15-0.2	0.06-0.35	105-150	0.25-0.35	4.3
		120-164	115-150	0.15-0.2	0.7-0.5	105-150	0.3-0.4	4.3
		160-204	115-150	0.15-0.2	0.7-0.5	105-150	0.3-0.4	4.3
	Alloy steel	25-33	100-130	0.05-0.15	0.05-0.15	90-120	0.15-0.25	2.2
		32-42	110-140	0.05-0.15	0.05-0.15	100-130	0.15-0.3	3.7
		40-55	110-150	0.05-0.15	0.05-0.15	100-130	0.2-0.3	3.7
		52-70	110-150	0.15-0.2	0.15-0.2	100-130	0.25-0.35	4.3
		120-164	110-150	0.15-0.2	0.15-0.2	100-130	0.3-0.4	4.3
		160-204	110-150	0.15-0.2	0.15-0.2	100-130	0.3-0.4	4.3
M	Stainless steel	25-33	70-100	0.07-0.15	0.07-0.15	60-90	0.12-0.2	2.2
		32-42	80-110	0.07-0.15	0.07-0.15	70-100	0.15-0.25	3.7
		40-55	80-110	0.07-0.15	0.07-0.15	70-100	0.15-0.25	3.7
		52-70	80-110	0.1-0.2	0.1-0.2	70-100	0.2-0.3	4.3
		120-164	80-110	0.1-0.2	0.1-0.2	70-100	0.25-0.35	4.3
		160-204	80-110	0.1-0.2	0.1-0.2	70-100	0.25-0.35	4.3
K	Cast Iron	25-33	70-100	0.07-0.15	0.12-0.35	60-110	0.2-0.3	2.2
		32-42	80-110	0.07-0.15	0.12-0.35	60-110	0.25-0.35	3.7
		40-55	80-110	0.07-0.15	0.2-0.5	60-110	0.25-0.35	3.7
		52-70	80-110	0.12-0.2	0.2-0.5	60-110	0.3-0.4	4.3
		120-164	80-110	0.12-0.2	0.25-0.75	60-110	0.3-0.45	4.3
		160-204	80-110	0.12-0.2	0.25-0.75	60-110	0.3-0.45	4.3
N	Aluminium alloy	25-33	150-300	0.05-0.15	0.12-0.35	120-300	0.2-0.3	2.2
		32-42	150-360	0.1-0.2	0.12-0.35	150-370	0.25-0.35	3.7
		40-55	150-360	0.1-0.2	0.2-0.5	150-370	0.25-0.35	3.7
		52-70	150-360	0.1-0.2	0.2-0.5	150-370	0.3-0.4	4.3
		120-164	150-360	0.1-0.25	0.25-0.75	150-370	0.3-0.45	4.3
		160-204	150-360	0.1-0.25	0.25-0.75	150-370	0.3-0.45	4.3
S	High temperature alloy and heat resistant alloy	25-33	30-40	0.07-0.15	0.12-0.35	25-35	0.12-0.2	2.2
		32-42	40-45	0.07-0.15	0.12-0.35	30-40	0.15-0.25	3.7
		40-55	40-45	0.07-0.15	0.2-0.5	30-40	0.15-0.25	3.7
		52-70	40-45	0.1-0.2	0.2-0.5	30-40	0.2-0.3	4.3
		120-164	40-45	0.1-0.2	0.25-0.75	30-40	0.25-0.35	4.3
		160-204	40-45	0.1-0.2	0.25-0.75	30-40	0.25-0.35	4.3

Recommended Cutting Data

R733-Reamer for Composite Mmaterial

Application	Work Piece		Ap (mm)	Feed (mm/rev)
			m/min	mm/rev
Reaming	N	CFRP、GFRP	60	0.08

CFRP: Carbon Fiber Reinforced Plastic GFRP: Glass Fiber Reinforced Plastic
 1.Please use the pneumatic tools with better rigidity, drill set, ensure processing stability.
 2.When using the small size cutting tool, reduce the tool feed 20%-30%.

R733-CM Reamer for Composite and Metal

Application	Work Piece		Ap (mm)	Feed (mm/rev)
			m/min	mm/rev
Reaming	N	CFRP	60	0.08
	N	Aluminium alloy	60	0.08
	N S	Titanium alloy	20	0.05
	N	Aluminium alloy	60	0.08
	S	Titanium alloy	15	0.05
	M	Stainless steel	15	0.05

CFRP: Carbon Fiber Reinforced Plastic GFRP: Glass Fiber Reinforced Plastic
 1.Please use the pneumatic tools with better rigidity, drill set, ensure processing stability.
 2.When using the small size cutting tool, reduce the tool feed 20%-30%.

D

Threading Tools



NEW

T100 High performance helical groove tap for steel

- Suitable for processing steel , machining hardness reaches 32HRC.
- New groove design for smoother chipping removal
- Optimized cutting edge processing method, better accuracy retention
- High-performance powder metallurgical high-speed steel with new coating, making it super toughness and wear resistance



T100

High performance helical groove tap for steel

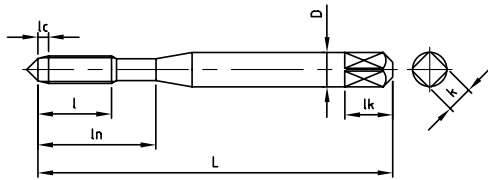

picture 1

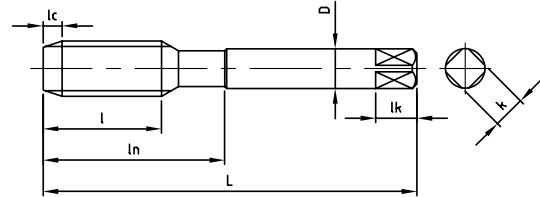

picture 2

Size of thread	Precision	Length of cutting cone lc	Length of thread l	Length of neck ln	Overall length L	Diameter of shank D	Figure	Number of groove	Size of square head		Diameter of bottom hole	Stock
									LK	a		
M3*0.5	6H	2.5P	6	17	46	4	Figure 1	3	6	3.2	2.5	●
M4*0.7	6H		7.5	21	52	5	Figure 1		7	4	3.3	●
M5*0.8	6H		9	25	60	5.5	Figure 1		7	4.5	4.2	●
M6*1	6H		11	29	62	6	Figure 1		7	4.5	5	●
M8*1.25	6H		13	34	70	6.2	Figure 2		8	5	6.8	●
M10*1.5	6H		16	38	75	7	Figure 2		8	5.5	8.5	●
M12*1.75	6H		18	-	82	8.5	Figure 2		9	6.5	10.3	○
M14*2	6H		20	-	88	10.5	Figure 2		11	8	12	○

● Standard Stock ○ Available Upon Order

Cutting parameter recommendation		
Material		Cutting speed(m/min)
Low-carbon steel	C < 0.25%	8 ~ 13
Medium- carbon steel	C=(0.25-0.45)%	7 ~ 12
High-carbon steel	C > 0.45%	6 ~ 9
Alloy steel	SCM	7 ~ 12

This table is for general choice. When processing, please adjust the cutting parameters according to the actual situation.

E

Appendix



Workpiece Material Table

ISO Material Group	MC	Workpiece Material	Content	Tensile Strength N/mm ²	Brinell Hardness HB	Rockwell Hardness HRC
P Steels	P1	Low-carbon Steels, Long Chipping	C<0.25%	<530	<125	
	P2	Low-carbon Steels, Short Chipping, Free-cutting Steels	C<0.25%	<530	<125	
	P3	High-carbon Steels, Medium-carbon Steels	C>0.25%	>530	<220	<25
	P4	Alloy Steels, Tool Steels.	C>0.25%	600-850	<330	<35
	P5	Alloy Steels, Tool Steels.	C>0.25%	850-1400	340-450	35-48
	P6	Ferritic Stainless Steels, Martensitic Stainless Steels, PH Stainless Steels	C=(0-0.4)%	600-900	<330	<35
	P7	High-strength Ferritic Stainless Steels, Martensitic Stainless Steels, PH Stainless Steels.	C=(0.1-0.6)%	900-1350	330-450	35-48
M Stainless Steels	M1	Austenitic Stainless Steels	C=(0.05-0.15)%	<600	130-200	
	M2	High-Strength Austenitic Stainless Steels and Cast Stainless Steels	C=(0.05-0.15)%	600-800	150-230	<25
	M3	Duplex Stainless Steels	C=(0.05-0.20)%	<800	135-275	<30
K Cast Iron	K1	Grey Cast Iron		125-500	120-290	< 32
	K2	Moderately Difficult Alloy Cast iron, Nodular Cast Iron.		<600	130-260	< 28
	K3	Difficult High-alloy Cast Iron, Nodular Cast Iron		>600	180-350	< 43
N Non-ferrous Materials	N1	Wrought Aluminium Alloys		<520	60-90	
	N2	Cast Aluminium Alloys	Si<12%	<350	70-100	
	N3	Cast Aluminium Alloys	Si>12%	200-320	60-120	
	N4	Copper, Copper Alloys		200-650	60-200	
	N5	Graphite, CFK, CFRP Graphite, Composite Materials		600-1500		
	N6	GFK, CFK Aluminium-based Composite Materials (MMCs)		<700	<210	
S Heat-resistant SuperAlloys, Titanium Alloys	S1	Iron-based Heat-resistant Alloys		500-1200	160-260	25-48
	S2	Cobalt-based Heat-resistant Alloys		1000-1450	250-450	25-48
	S3	Nickel-based Heat-resistant Alloys		600-1700	160-450	<48
	S4	Titanium and Titanium Alloys		900-1600	300-400	33-48
H Hardened Materials	H1	Hardened Steels				45-55
	H2	Hardened Steels				55-60
	H3	Hardened Steels				60-65
	H4	Hardened Steels				>65

The Structure of Shank-DIN Standard

DIN 6535-HA



d·h ₀	2	3	4	5	6	8	10	12	14	16	18	20	25	32
l_{1+2} 0	28				36		40	45		48		50	56	60

DIN 6535-HB

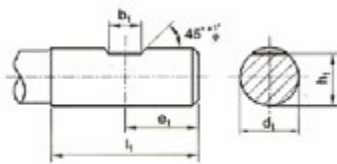

d₁=6-20mm

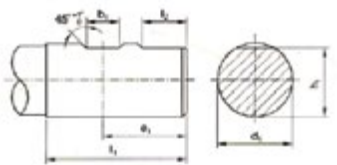

d₁=25-32mm

d ₁ h ₀	b ₁ +0.05 0	e ₁ 0 -1	h ₁ h ₁₁	l ₁ +2 0	l ₂ +1 0
6.0	4.2	18.0	5.1	36.0	
8.0	5.5		6.9		
10	7.0		8.5		
12	8.0	22.5	10.4	45.0	
14			12.7		
16	10.0	24.0	14.2	48.0	
18			16.2		
20	11.0	25.0	18.2	50.0	
25	12.0	32.0	23.0	56.0	17.0
32	14.0	36.0	30.0	60.0	19.0

DIN 6535-HE

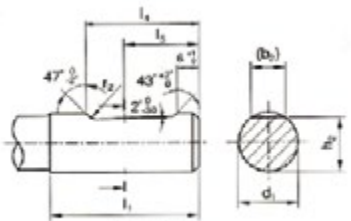

d₁=6-20mm

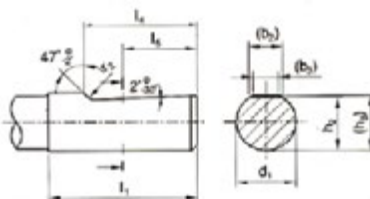

d₁=25-32mm

d ₁	(b ₂)	(b ₃)	(h ₂)	(h ₃)	l ₁	l ₄	l ₅	r ₂
6.0	4.3		5.1		36.0	25.0	18.0	1.2
8.0	5.5		6.9					
10	7.1		8.5					
12	8.2		10.4		45.0	33.0	22.5	
14	8.1		12.7					
16	10.1		14.2		48.0	36.0	24.0	
18	10.8	16.2						
20	11.4	18.2	50.0	38.0	25.0	1.6		
25	13.6	9.3	23.0	24.1	56.0		44.0	32.0
32	15.5	9.9	30.0	31.2	60.0		48.0	35.0

Cutting Calculations and Definitions

Parameter and Unit		
D Diameter	(mm)	F _n Feed per Revolution (mm/rev)
a _p Cutting Depth	(mm)	f _z Feeding per Teeth (mm/tooth)
a _e Cutting Width	(mm)	Z Number of Teeth
V _f Feed Rate	(mm/min)	n Spindle Speed (rev/min)
V _c Cutting Speed	(m/min)	L Length (mm)
Q Rate of Metal Removal	(cm ³ /min)	T _c Processing Time (min)

General Formula	
n Spindle Speed	$n = \frac{V_c \cdot 1000}{\pi \cdot D} \text{ (rev/min)}$
V _c Cutting Speed	$V_c = \frac{\pi \cdot D \cdot n}{1000} \text{ (m/min)}$
V _f Feed Rate	$V_f = f_z \cdot z \cdot n \text{ (mm/min)}$
f _z Feed per Teeth	$f_z = \frac{V_f}{z \cdot n} \text{ (mm)}$
Q Rate of Metal Removal	$Q = \frac{a_e \cdot a_p \cdot V_f}{1000} \text{ (cm}^3\text{/min)}$
T _c Processing Time	$T_c = \frac{L}{V_f} \text{ (min)}$

Comparison Table for Tensile Strength , Brinell Hardness and Rockwell Hardness

N/mm2	HV10	HB	HRC
240	75	71	
255	80	76	
270	85	81	
285	90	86	
305	95	90	
320	100	95	
335	105	100	
350	110	105	
370	115	109	
385	120	114	
400	125	119	
415	130	124	
430	135	128	
450	140	133	
465	145	138	
480	150	143	
495	155	147	
510	160	152	
530	165	157	
545	170	162	
560	175	166	
575	180	171	
595	185	176	
610	190	181	
625	195	185	
640	200	190	
660	205	195	
675	210	199	
690	215	204	
705	220	209	
720	225	214	
740	230	219	
755	235	223	
770	240	228	
785	245	233	
800	250	238	22
820	255	242	23
835	260	247	24
860	268	255	25
870	272	258	26
900	280	266	27

N/mm2	HV10	HB	HRC
920	287	273	28
940	293	278	29
970	302	287	30
995	310	295	31
1020	317	301	32
1050	327	311	33
1080	336	319	34
1110	345	328	35
1140	355	337	36
1170	364	346	37
1200	373	354	38
1230	382	363	39
1260	392	372	40
1260	403	383	41
1330	413	393	42
1360	423	402	43
1400	434	413	44
1440	446	424	45
1480	458	435	46
1530	473	449	47
1570	484	460	48
1620	497	472	49
1680	514	488	50
1730	527	501	51
1790	544	517	52
1845	560	632	53
1910	578	549	54
1980	596	567	55
2050	615	584	56
2140	639	607	57
	655	622	58
	675		59
	698		60
	720		61
	745		62
	773		63
	800		64
	829		65
	864		66
	900		67
	940		68

Service of Tool Regrinding

Through the system of grinding process and strict process quality control, Xiamen GESAC will let your wear tool to recover full new state. One more time to regrinding, to extend the tool life. Practical data show, reasonable tool grinding can save more than 50% of the total investment cost of tool.

Regrinding process can not only helps you save investment, reduce inventory, but also effectively avoid the waste of materials, saving resources and protecting the environment.

Xiamen GESAC cutter grinding service will help you achieve the dream of processing.

You only need to contact the nearest Xiamen GESAC agents to make your tool to restore as new!

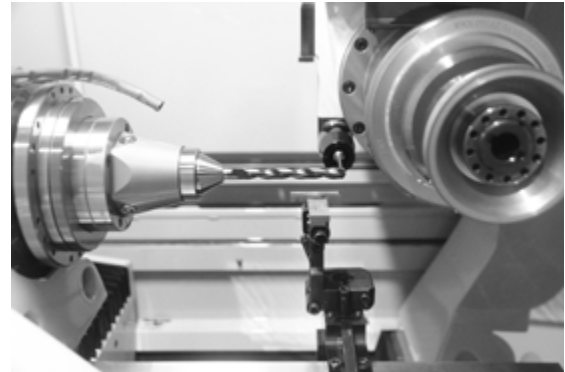
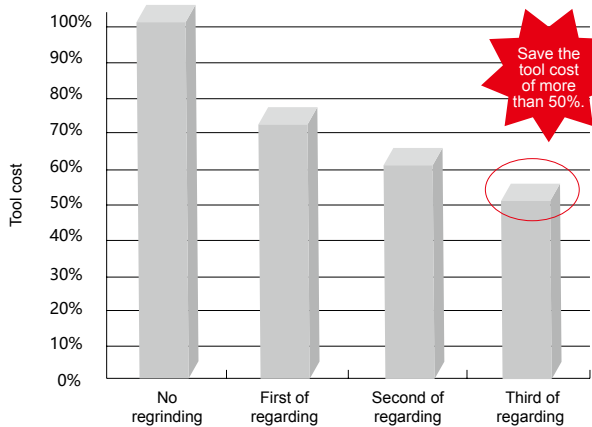

► Please follow these steps

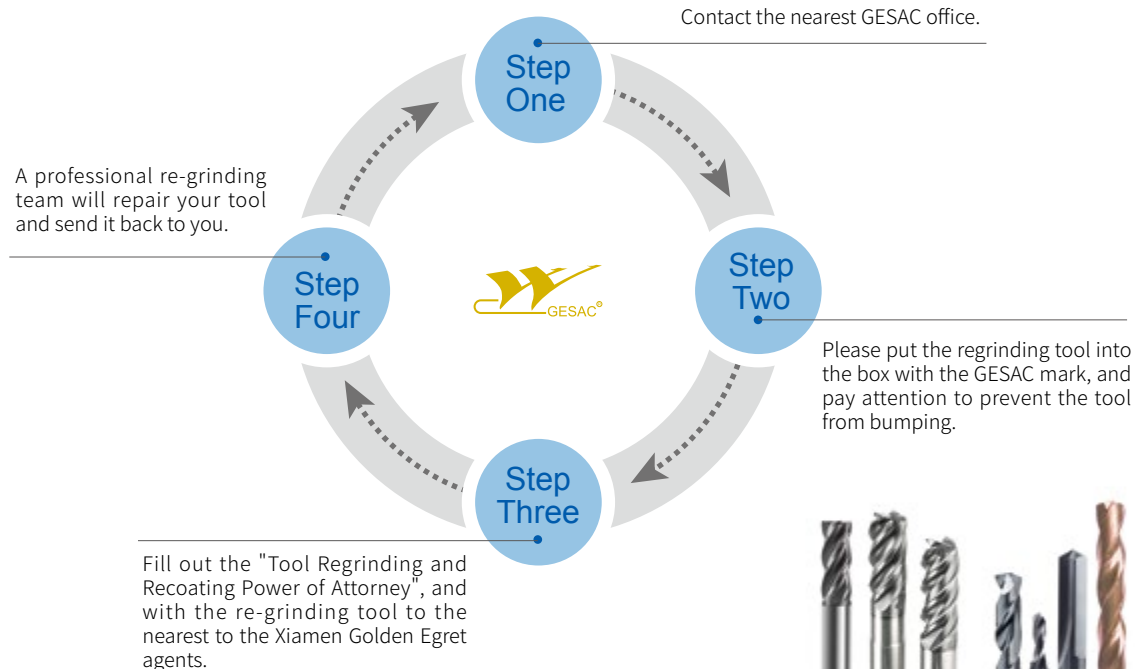

► GESAC provides regrinding services for a wide range of tool products, including

- Solid carbide drill
- Solid carbide endmill
- Solid carbide step drill





XIAMEN GOLDEN EGRET SPECIAL ALLOY CO.,LTD.

Factory Add: No.1601-1629 Jicheng Road Industrial
Concentration Area Tongan Xiamen CHINA

Tel: +86-0592-7255172

Fax: +86-0592-7107322

P.C: 361006

Email: gesac@cxtc.com

Http://www.gesac.com.cn

www.gesac.com.cn



BST201906c
